

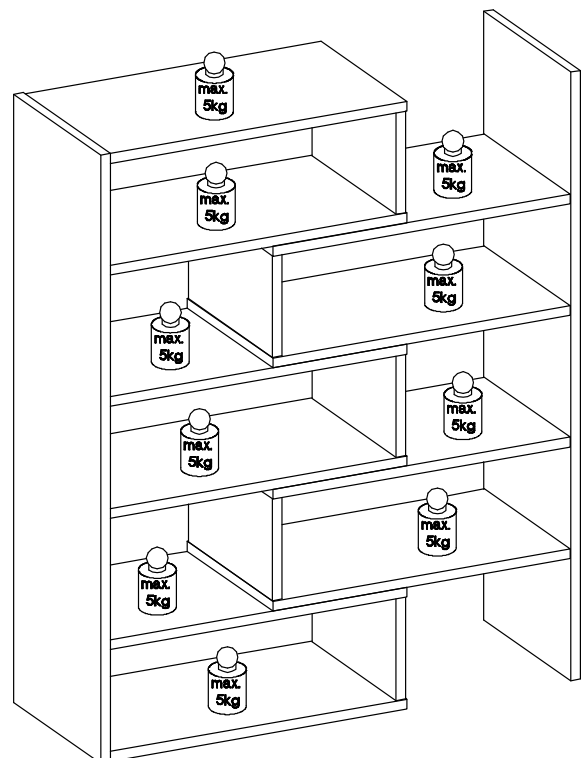

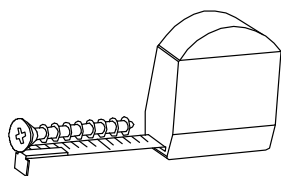

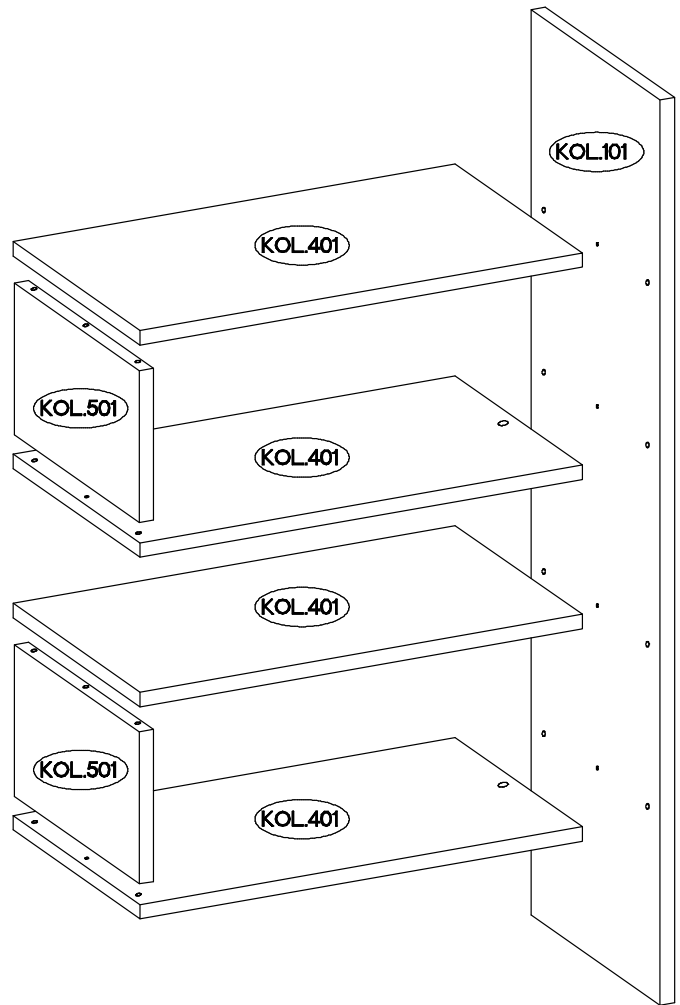

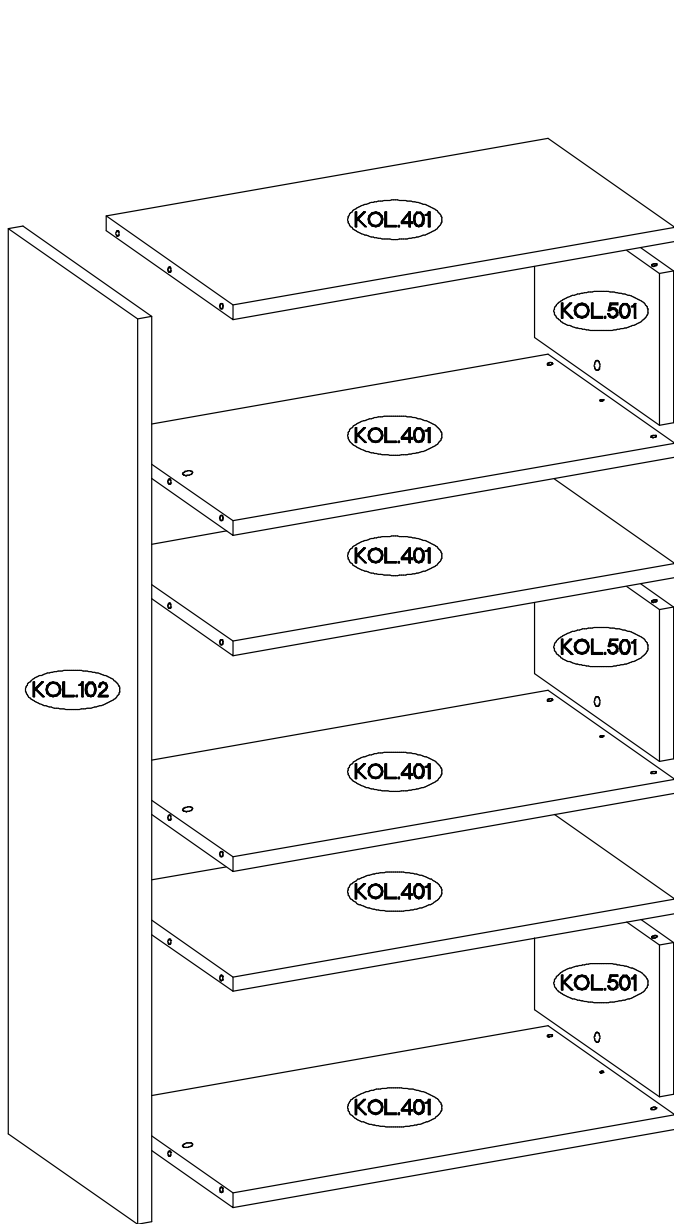

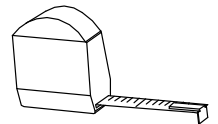
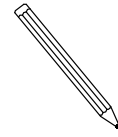
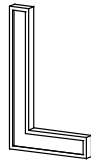
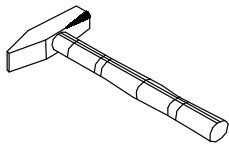
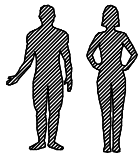

KARDAL

MONTÁŽNÍ NÁVOD/MONTAZHNY NÁVOD



 #8x30mm A 40	 L=20mm D2 20	 #15/12mm C 20	 #15x5mm F4 6	 E 20	 0,05 O11 1
--	---	--	---	--	---

1.

$\varnothing 8 \times 30 \text{ mm}$  A	L=20mm  D2	$\varnothing 15/12 \text{ mm}$  C	0,05  O11
40	20	20	1

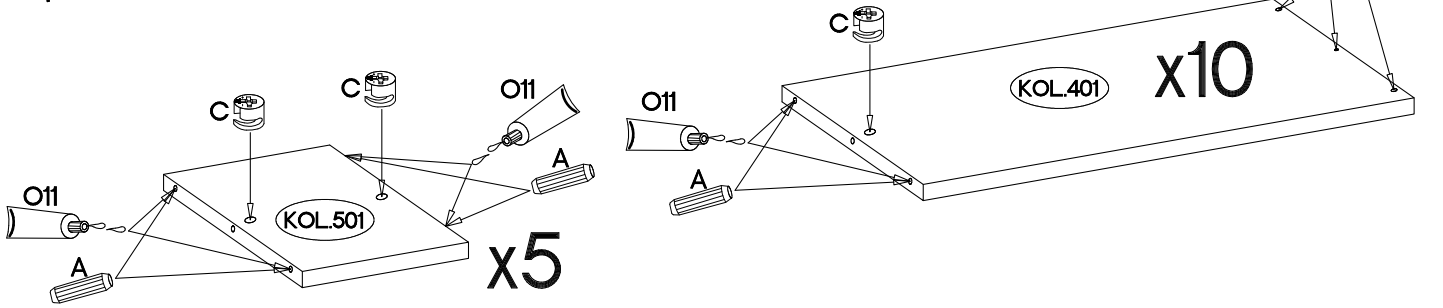
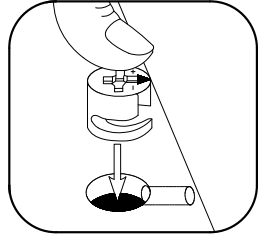
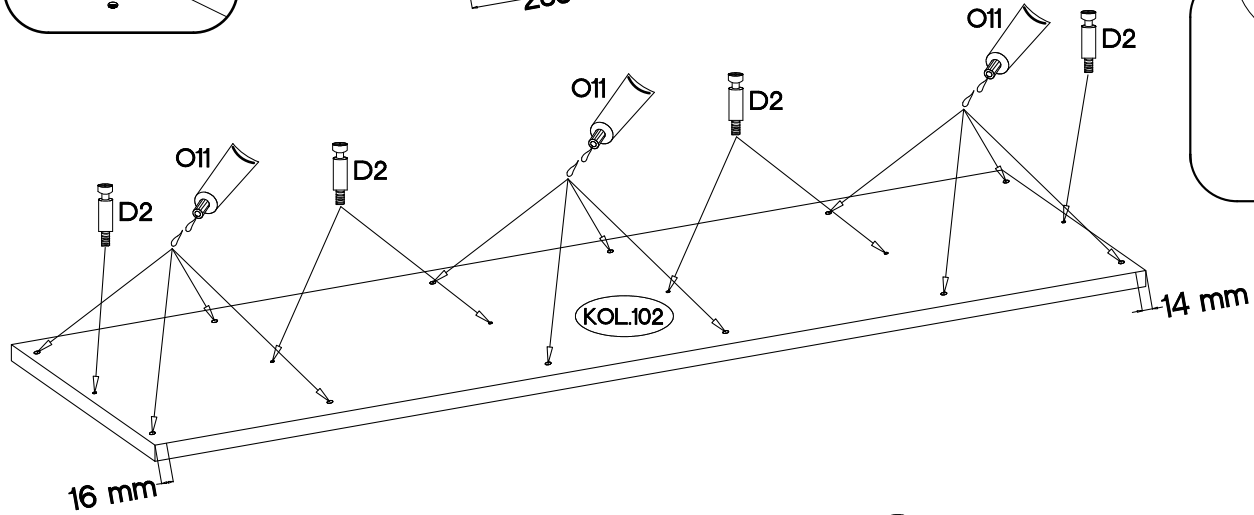
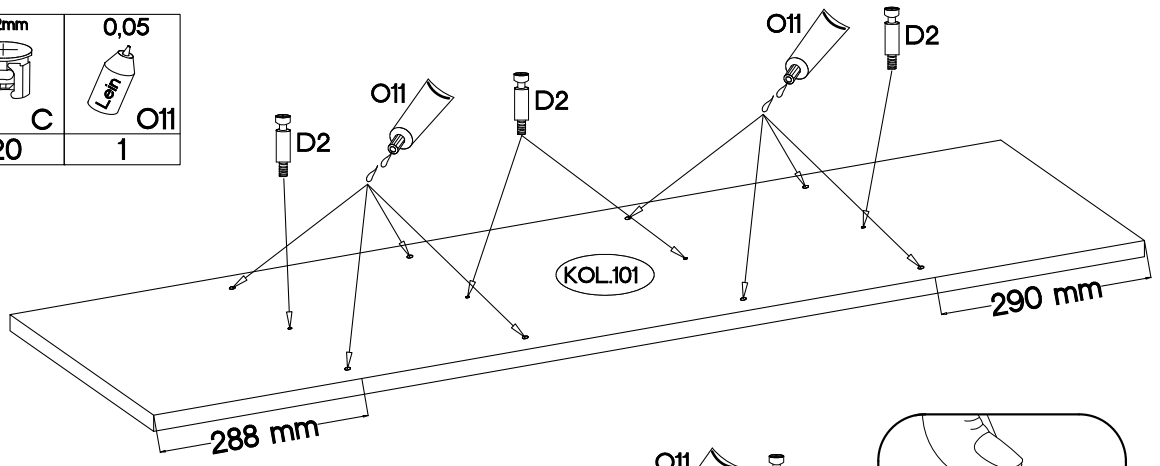
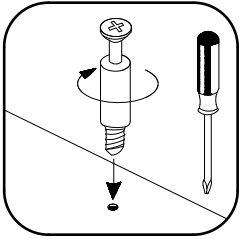

2.

