

120 min

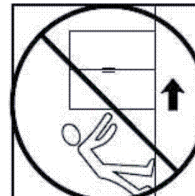

LE TRI + FACILE

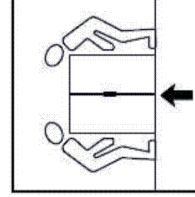
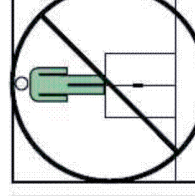
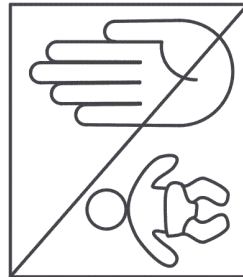
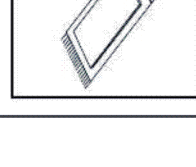
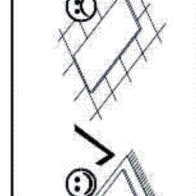
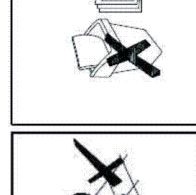
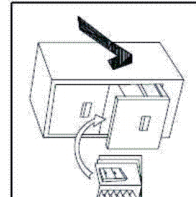
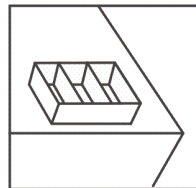
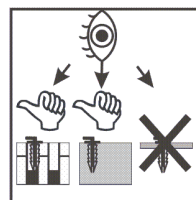
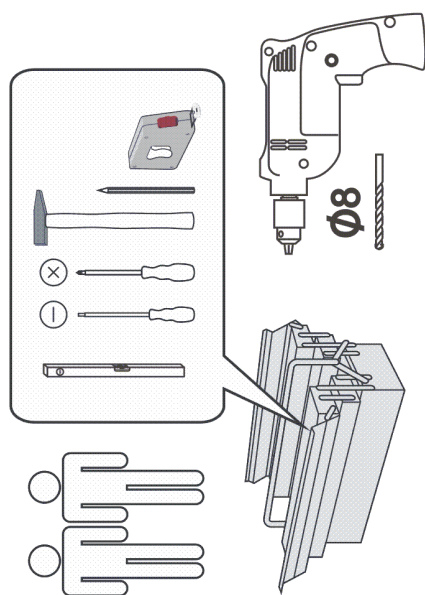

FR

Pensez à donner ou recycler.



ou



ou



Déchèterie

<https://quefairedemesdechets.fr>

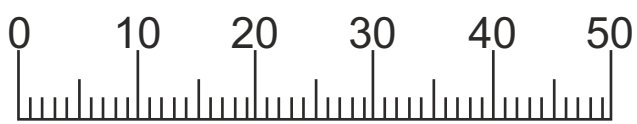
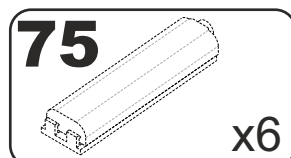
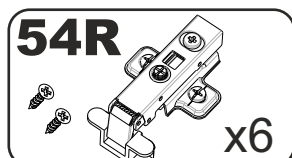
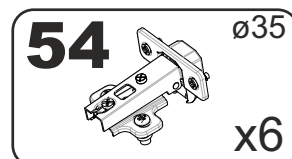
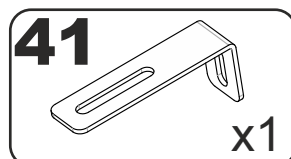
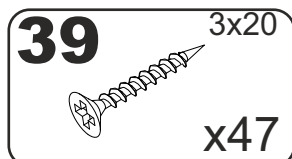
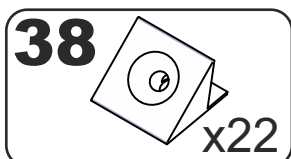
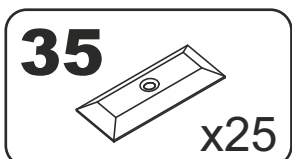
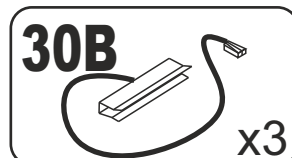
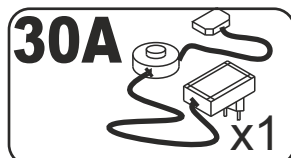
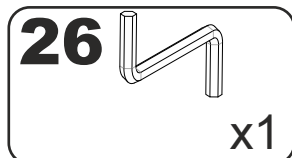
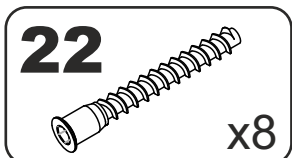
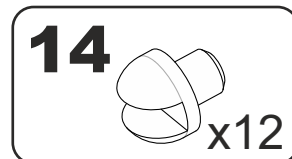
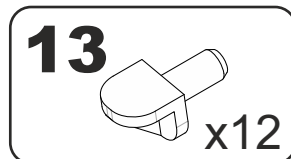
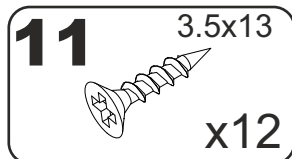
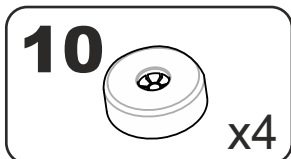
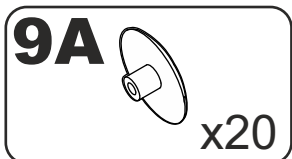
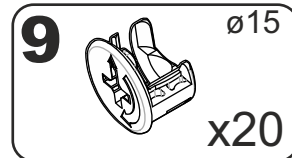
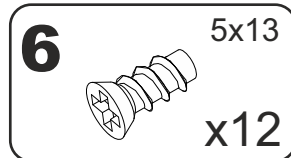
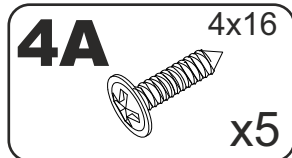
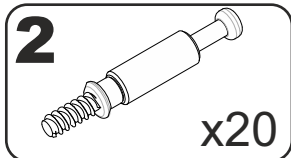
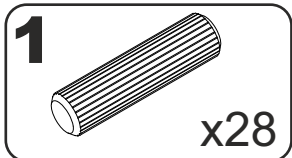
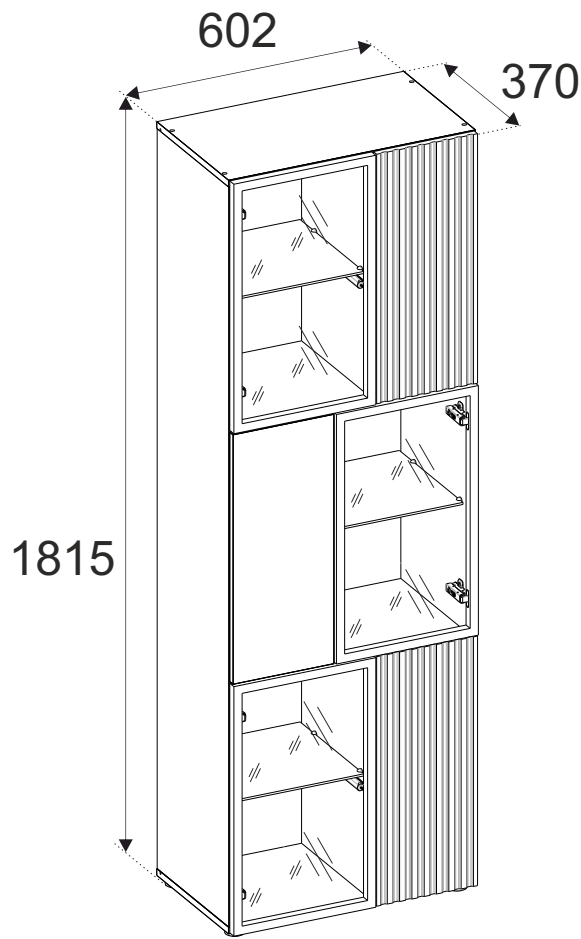
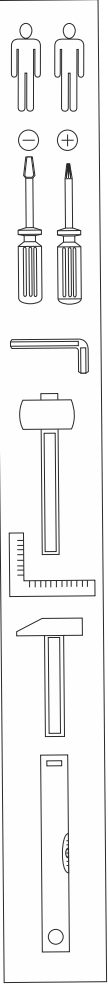

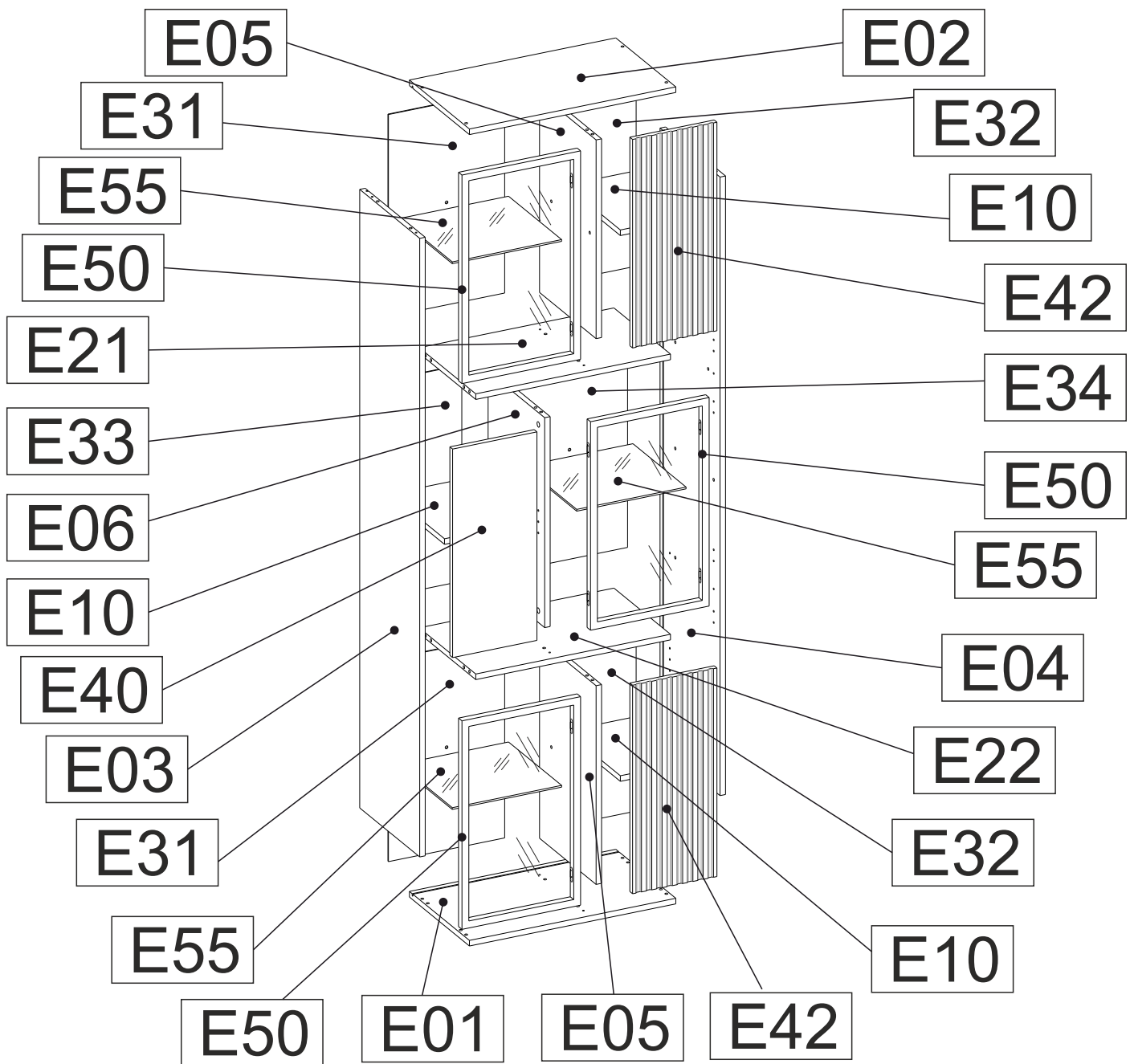

A	B_(mm)	C_(mm)	D_(mm)	E	F
E50	596	346	20	3	1 2
E01	602	350	16	1	2 2
E02	602	350	16	1	2 2
E03	1768	350	16	1	2 2
E04	1768	350	16	1	2 2
E05	568	330	16	2	1 2
E06	600	330	16	1	1 2
E10	226	320	16	3	1 2
E21	568	330	16	1	1 2
E22	568	330	16	1	1 2
E31	578	339	3	2	1 2
E32	578	239	3	2	1 2
E33	618	239	3	1	1 2
E34	618	339	3	1	1 2
E40	596	246	16	1	1 2
E42	596	246	16	2	1 2
E55	319	310	5	3	1 2

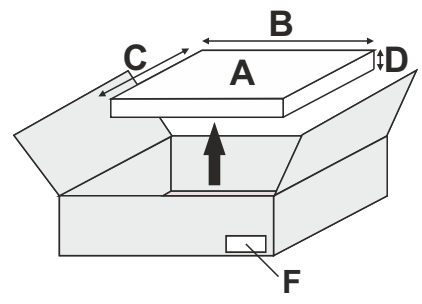

1

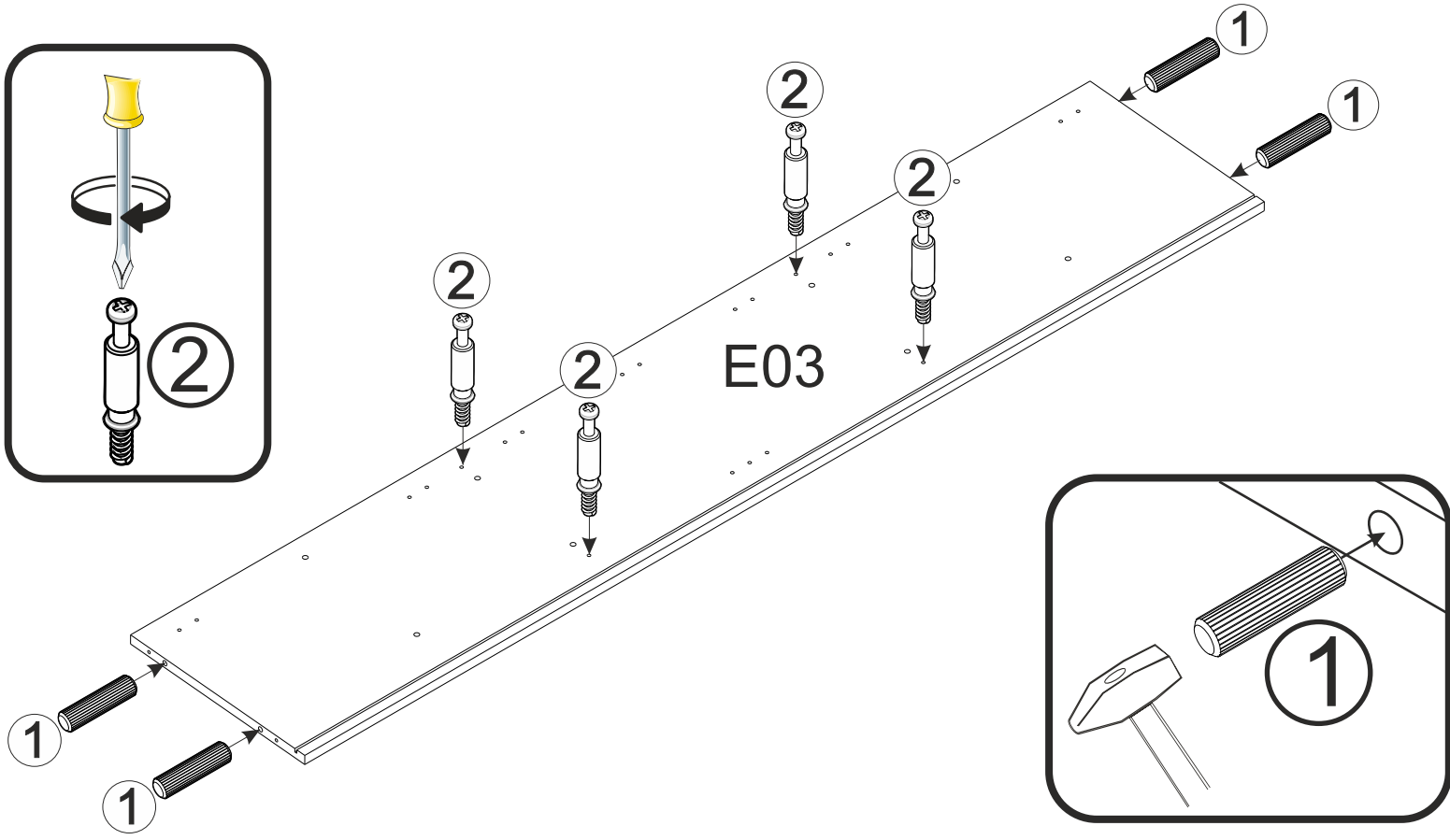
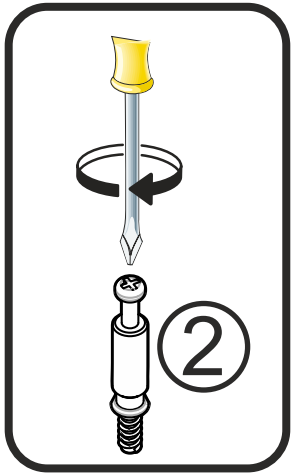
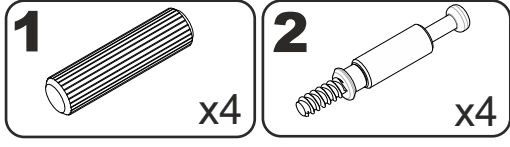

2

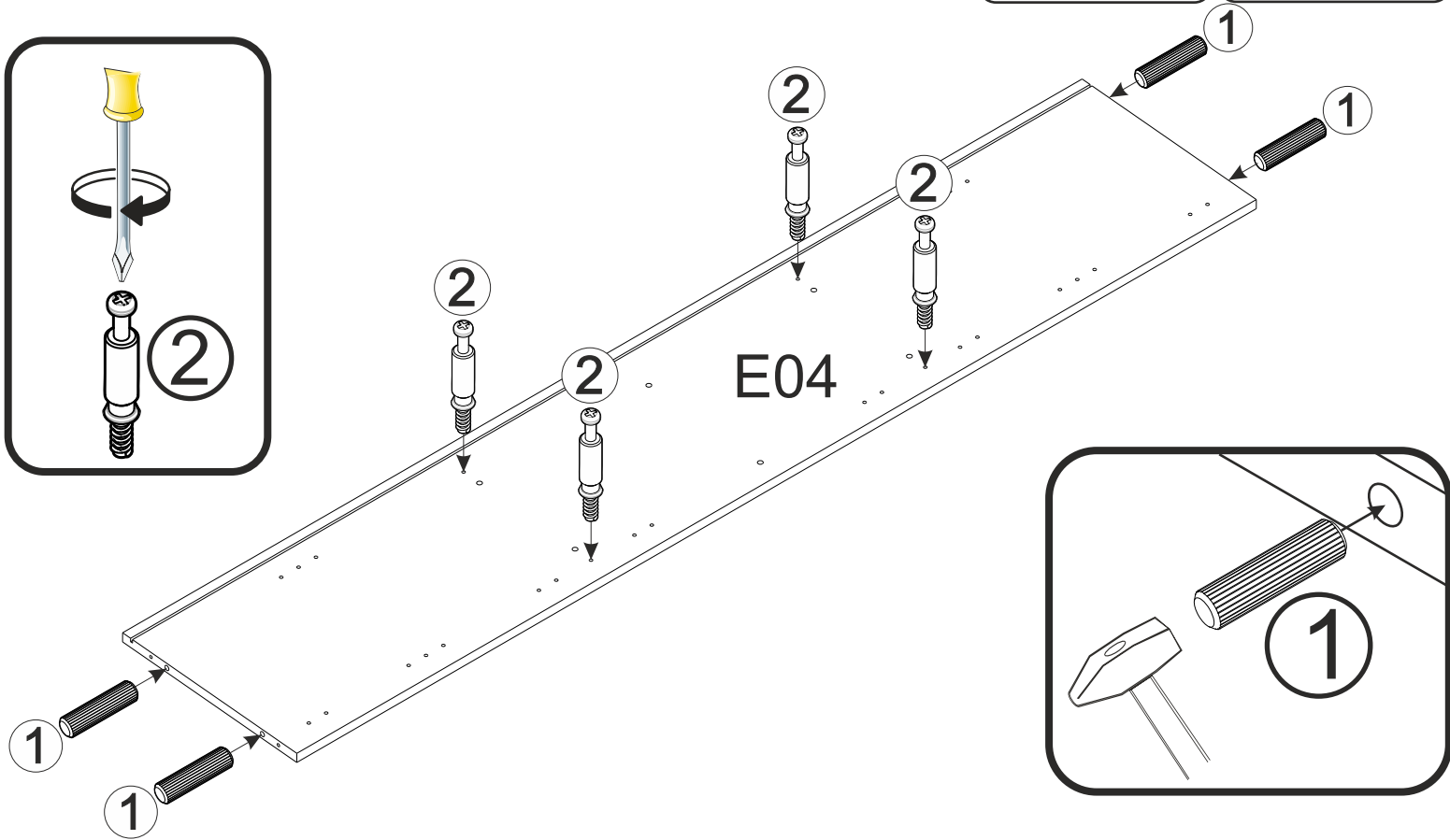
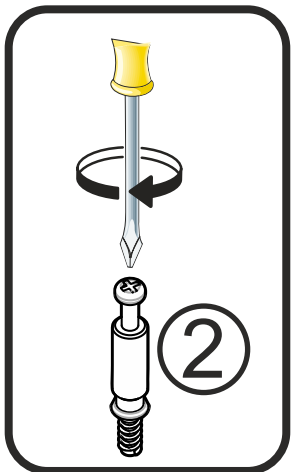

3

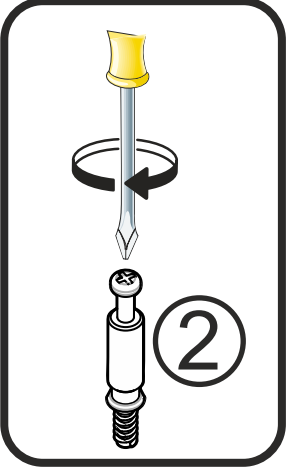
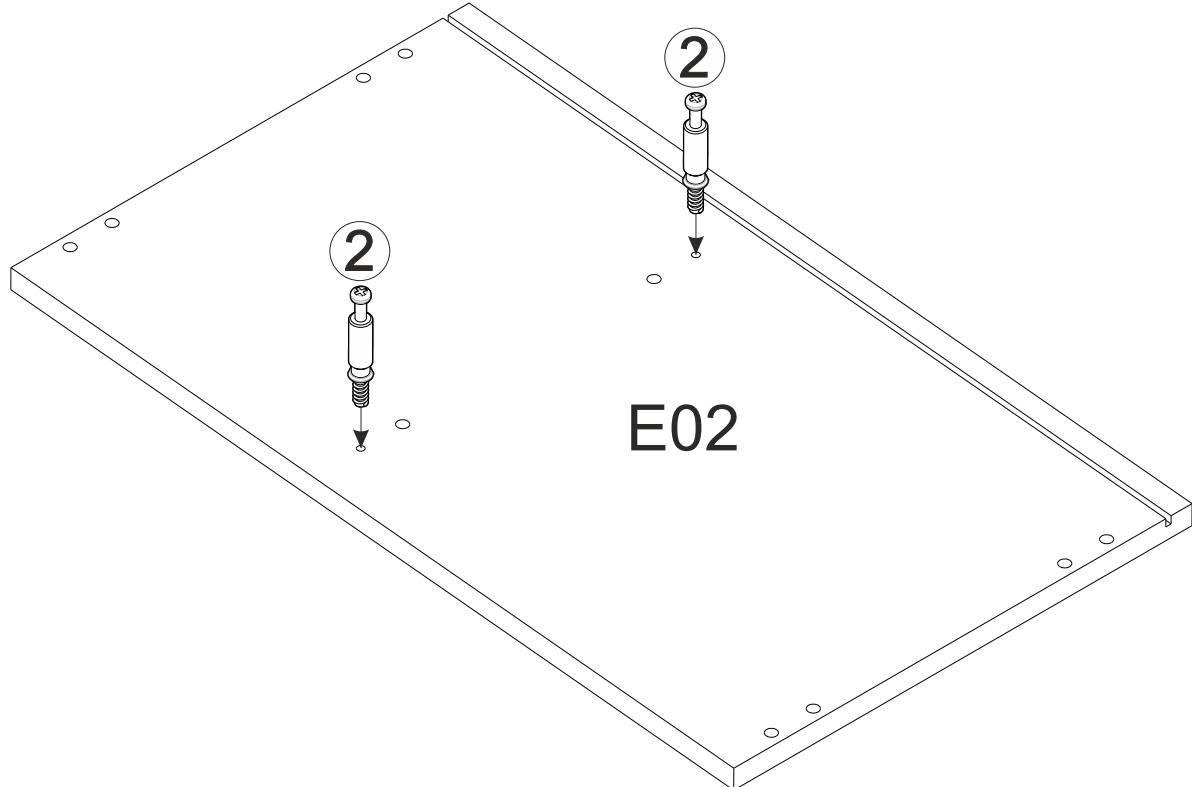
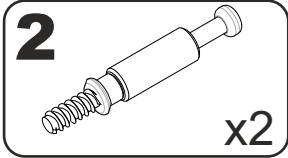

4

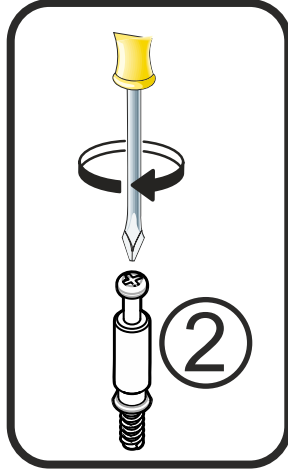
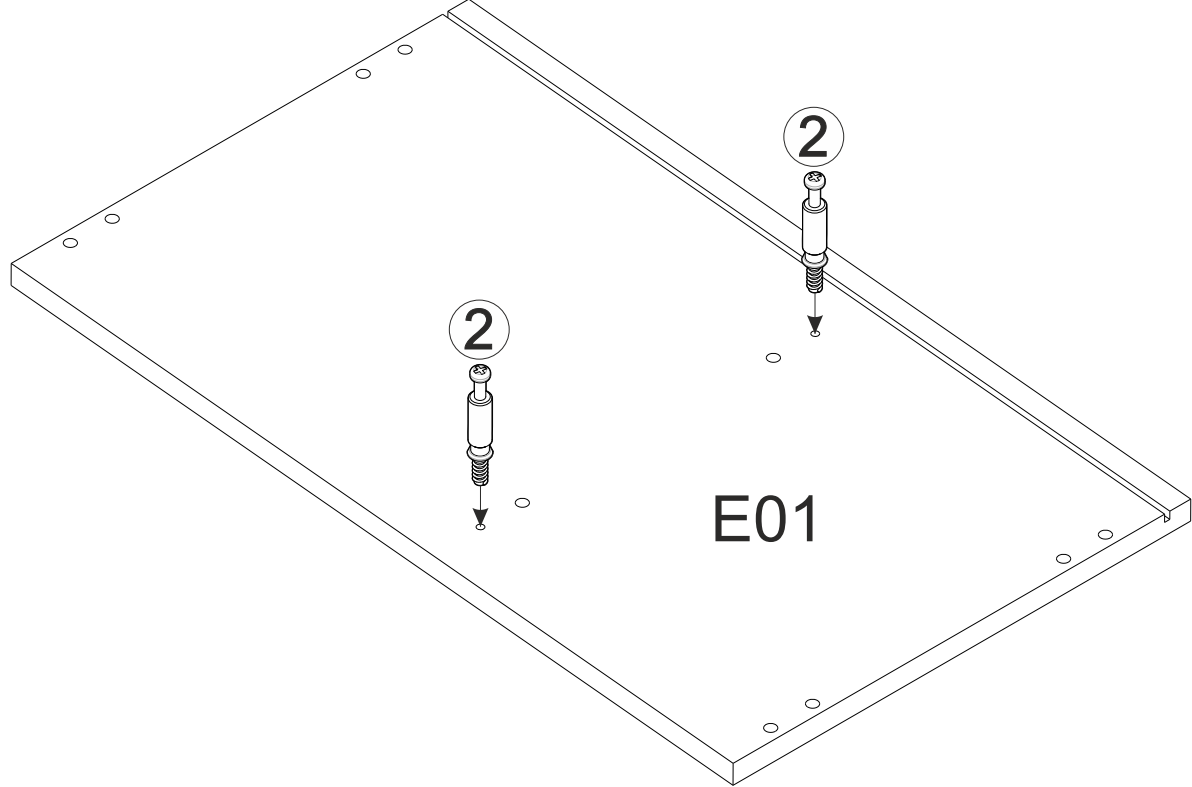
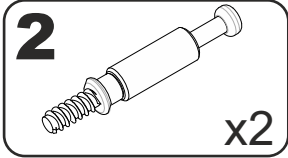

5

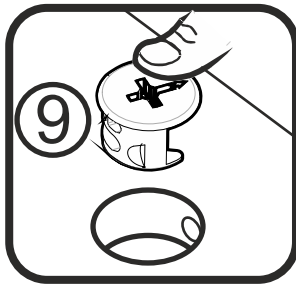
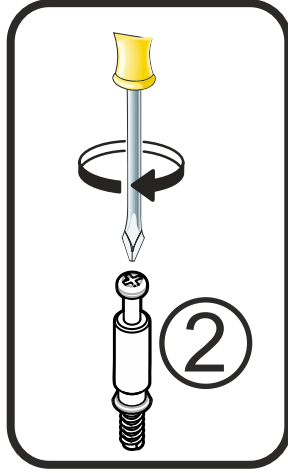
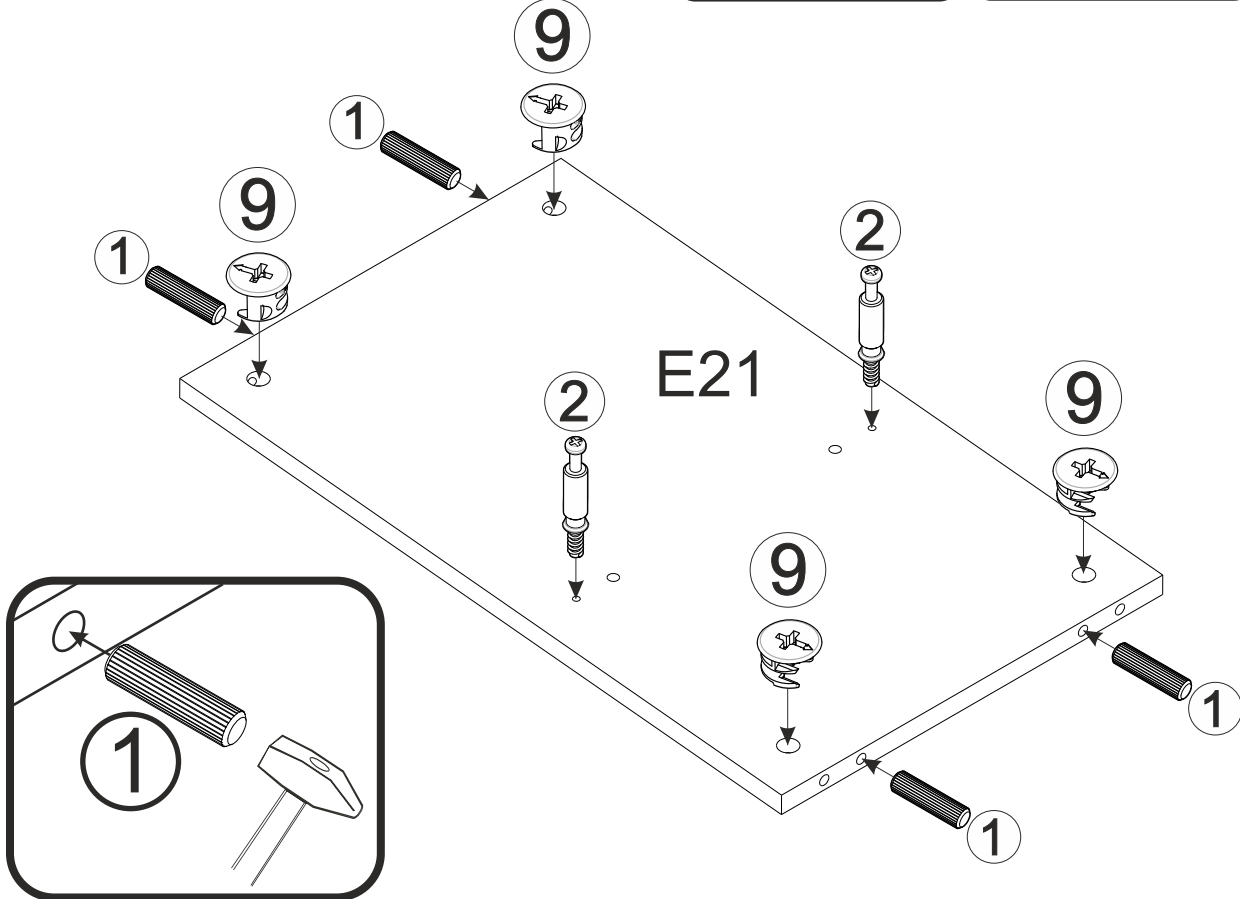
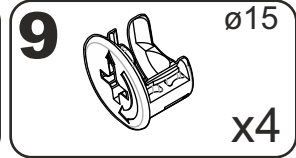
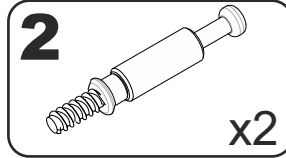
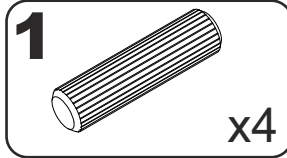

6

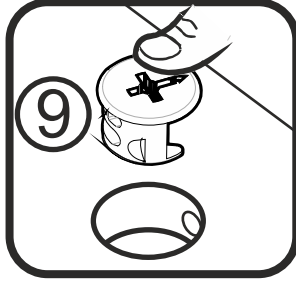
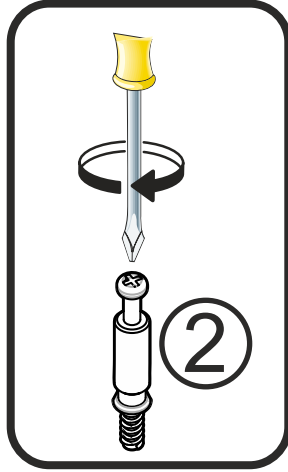
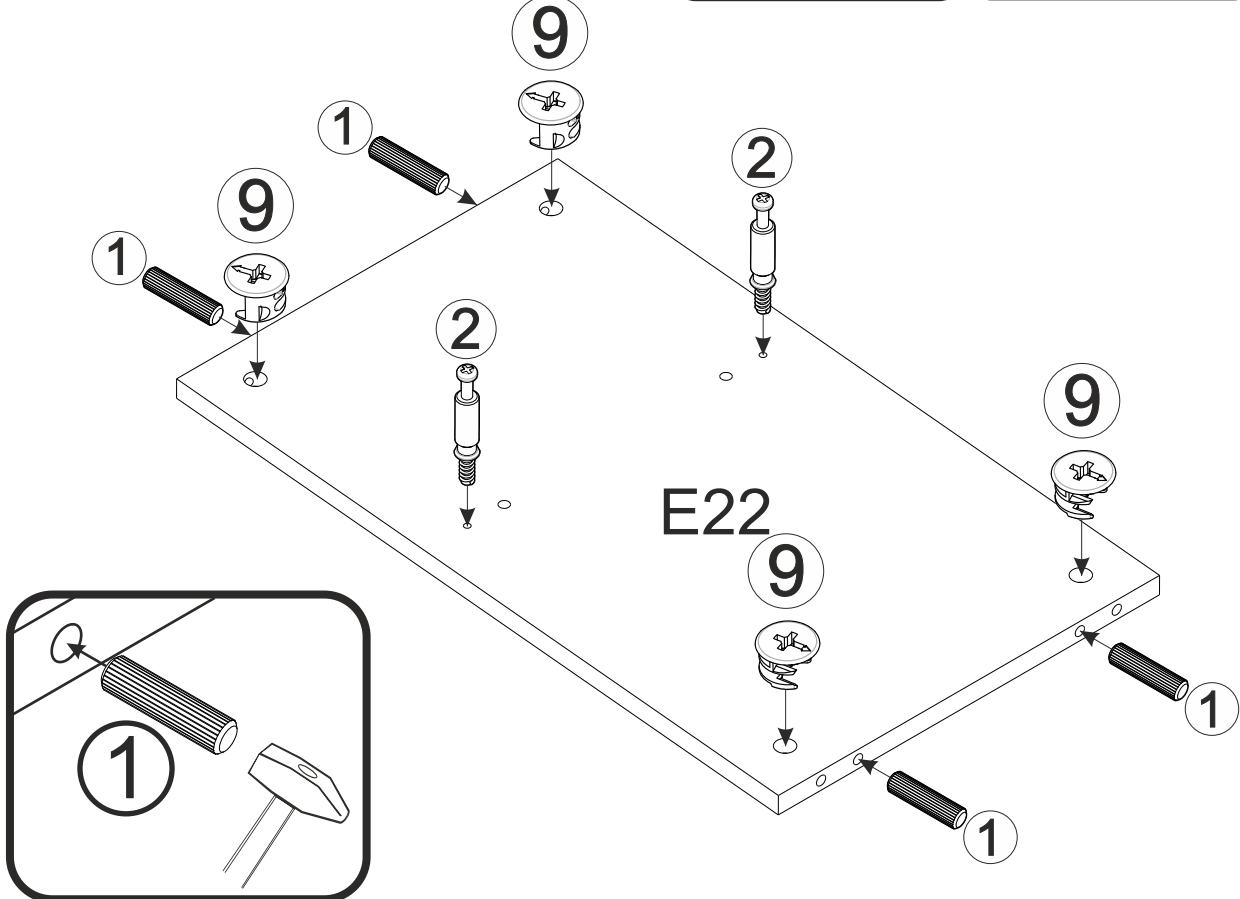
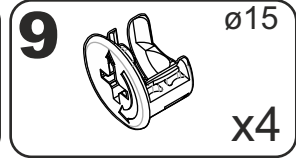
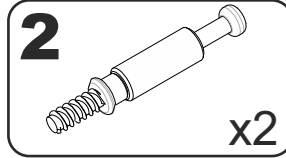
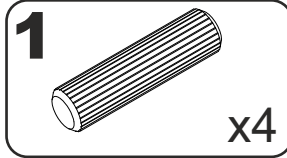

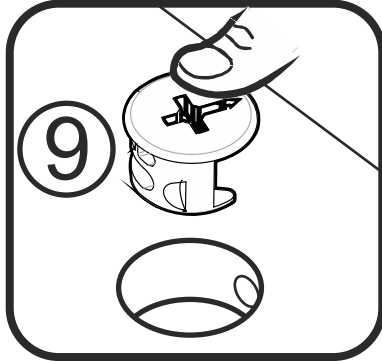
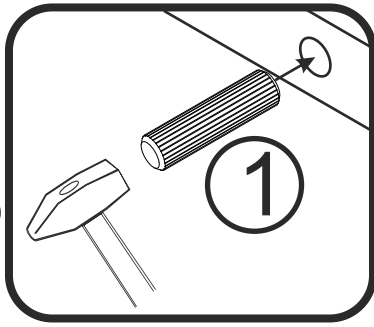
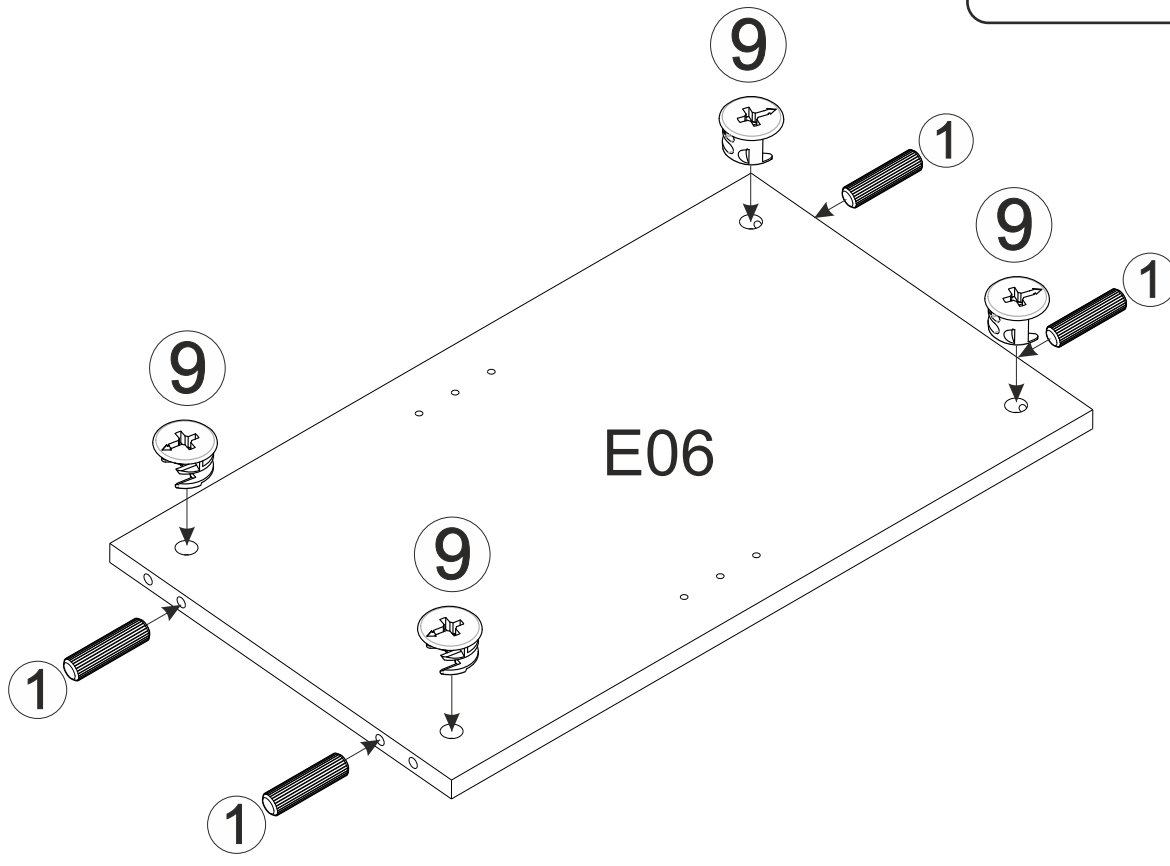
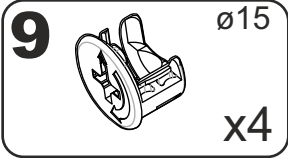
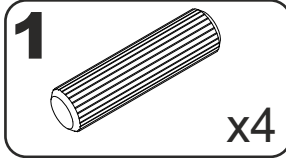
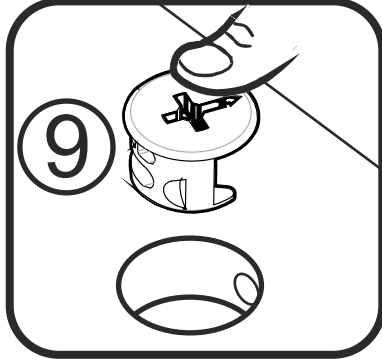
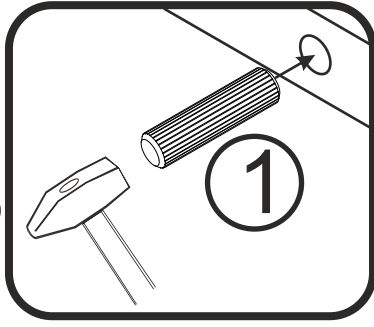
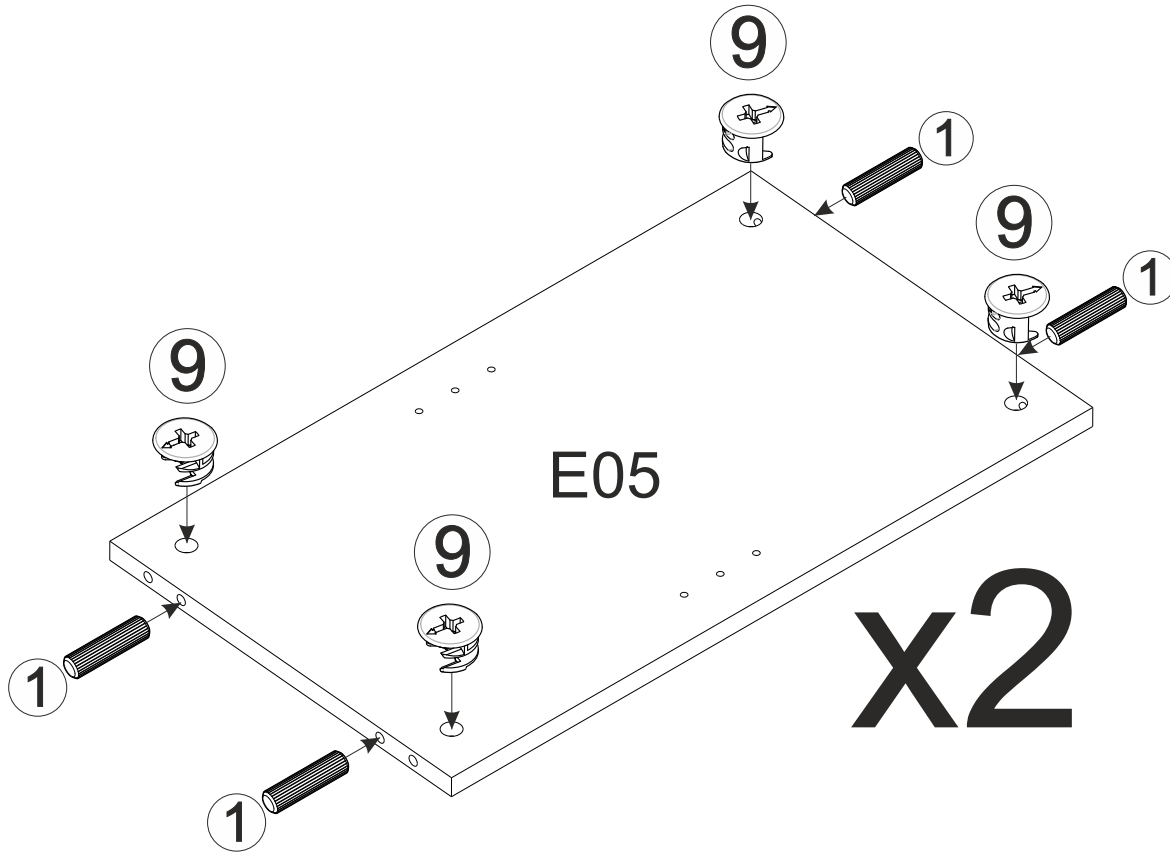
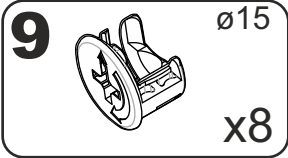
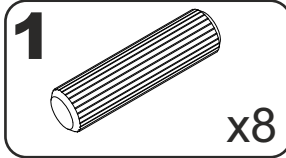

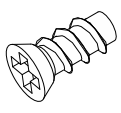

9

6 5x13
x8

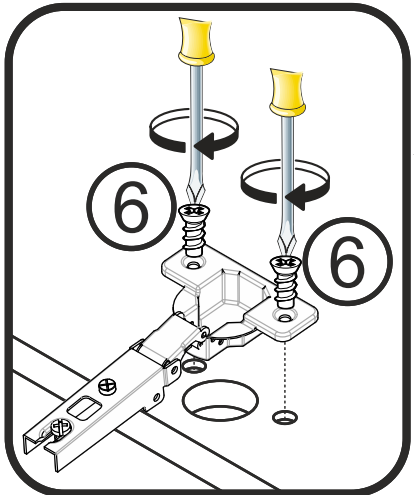
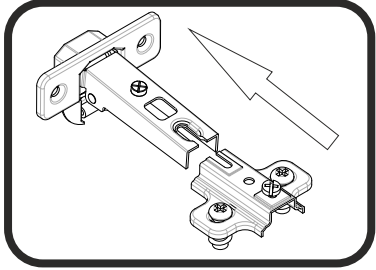
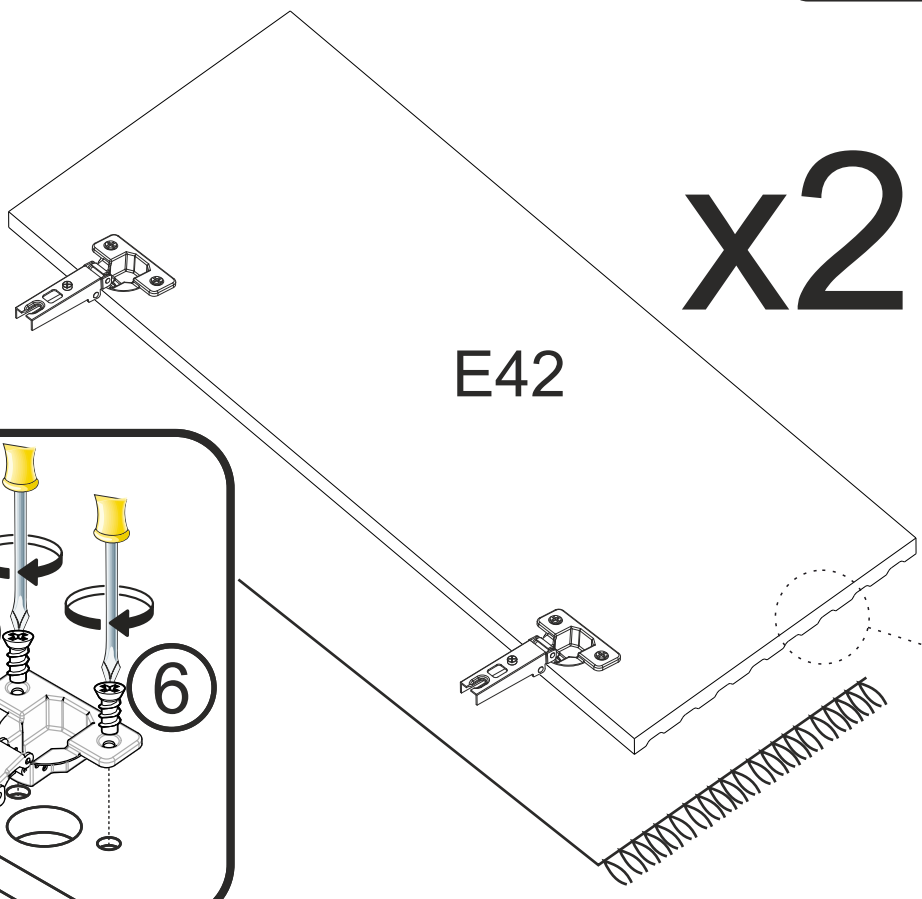

54 ø35
x4



10

6 5x13
x4

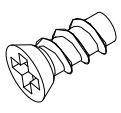

54 ø35
x2

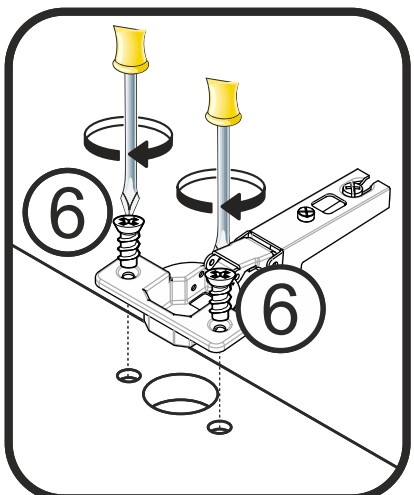
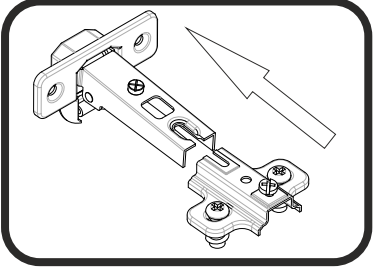
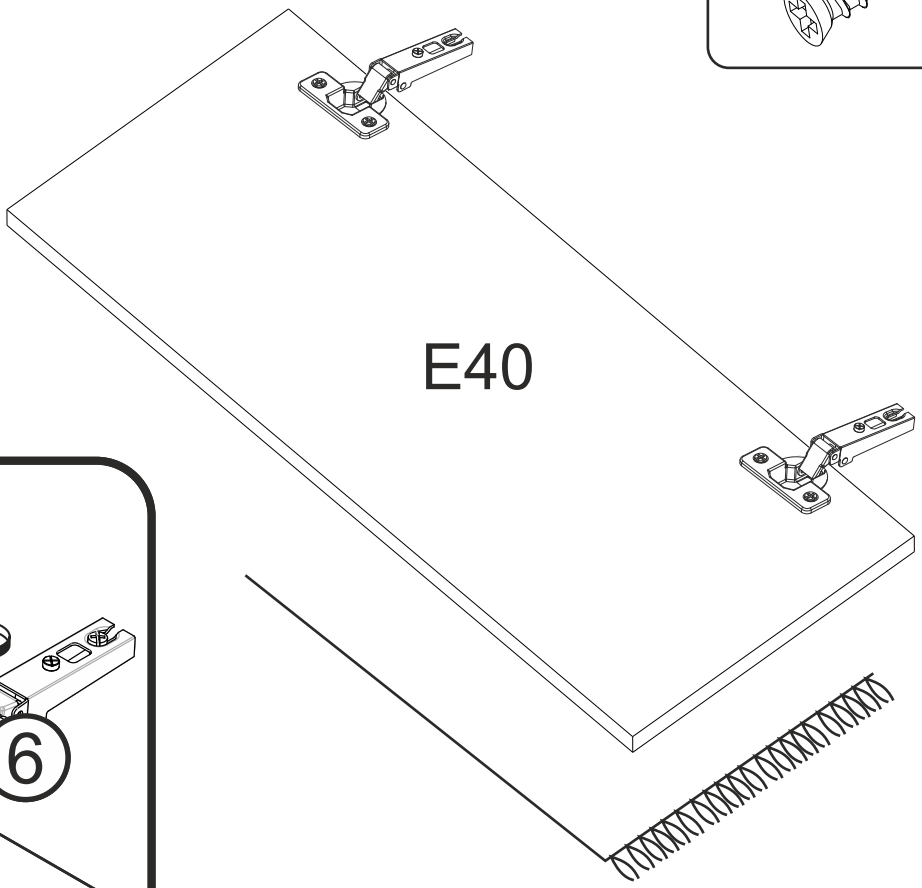
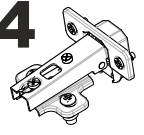

11

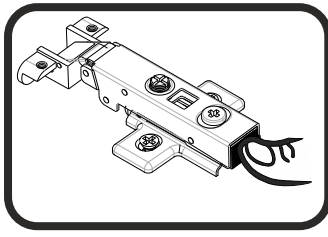
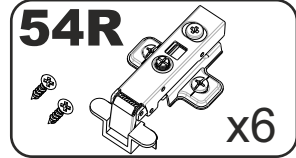
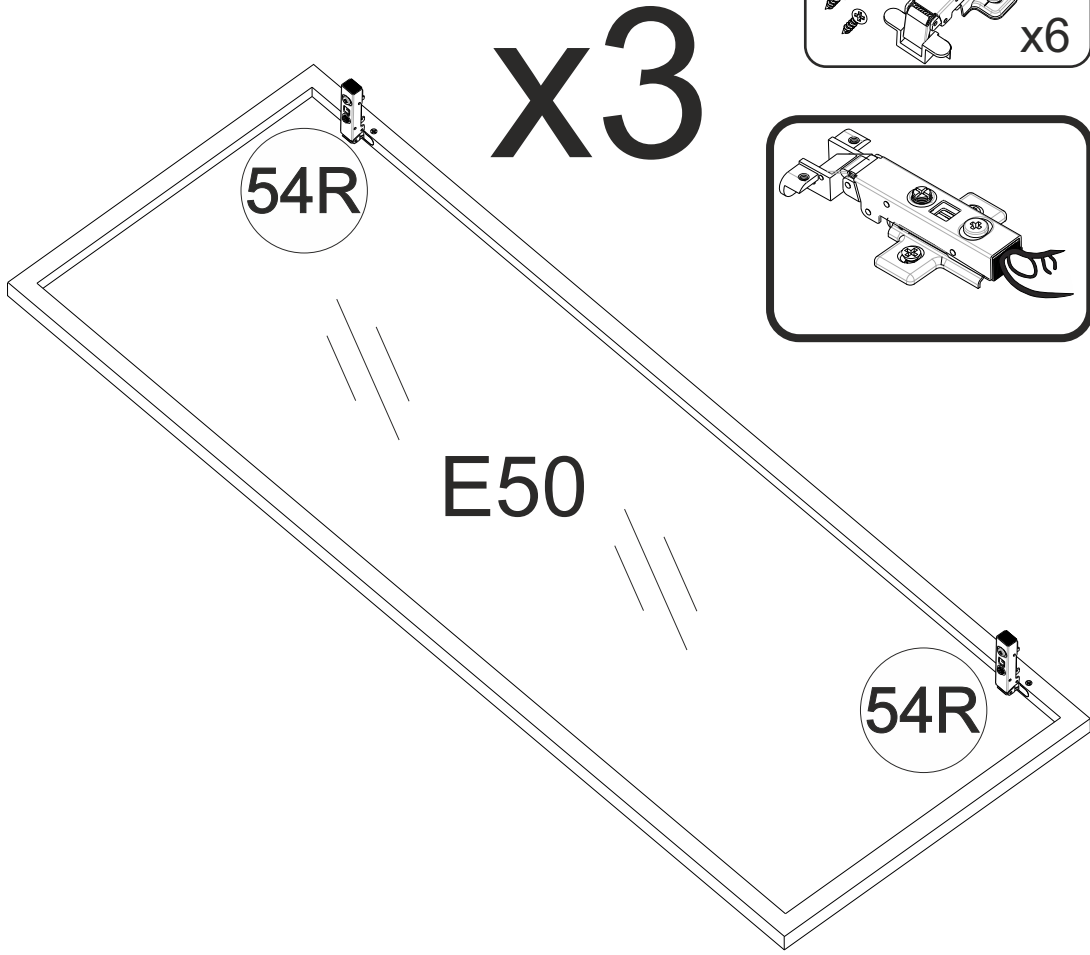
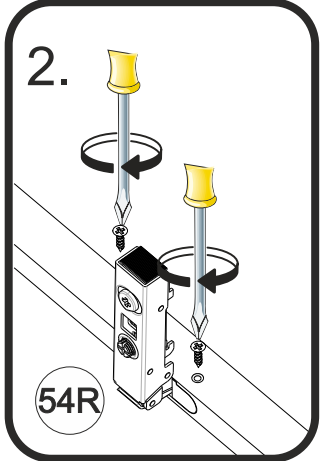
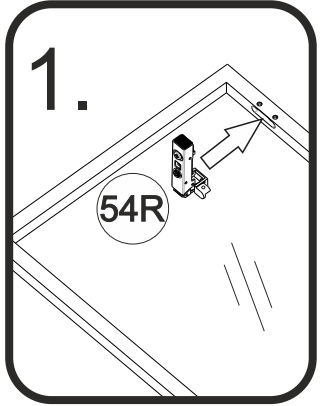

12

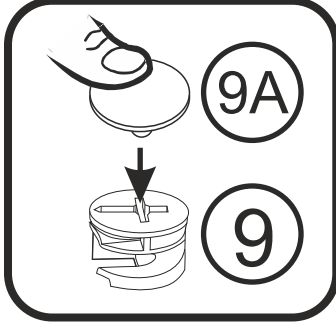
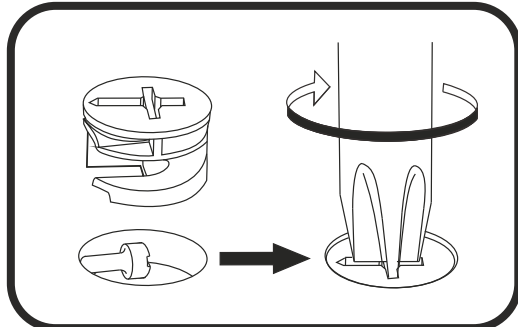
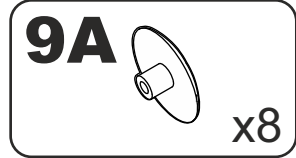
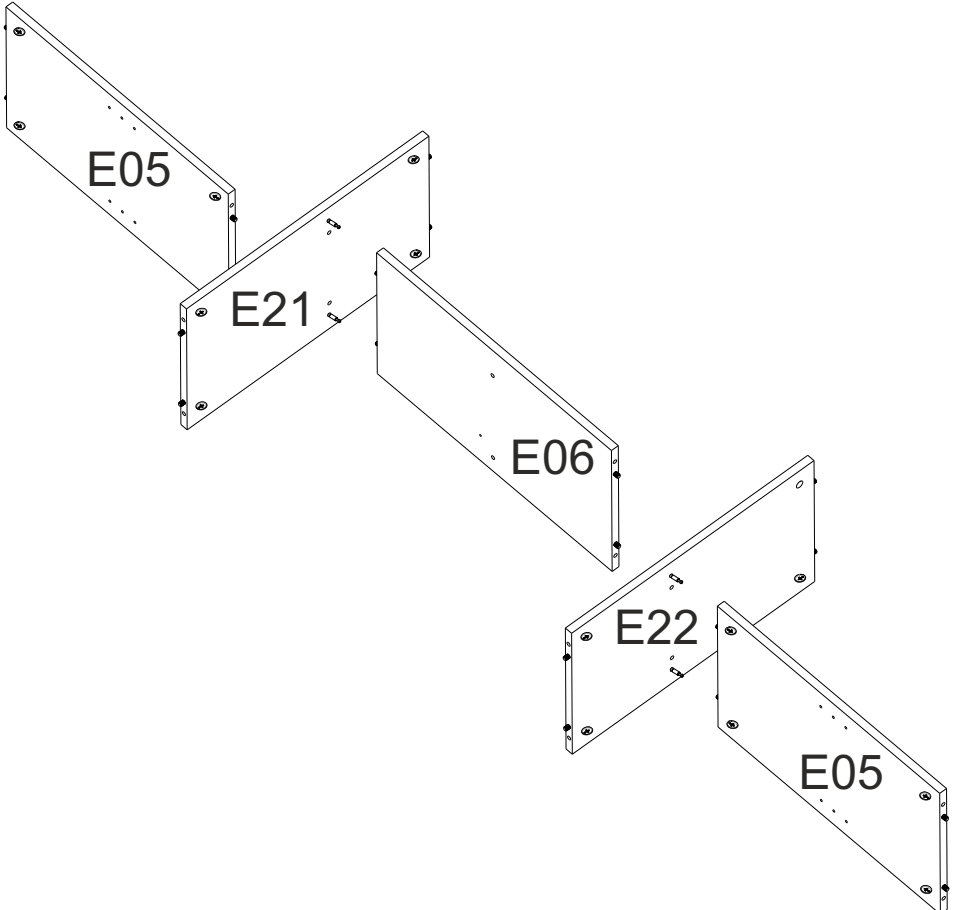

13

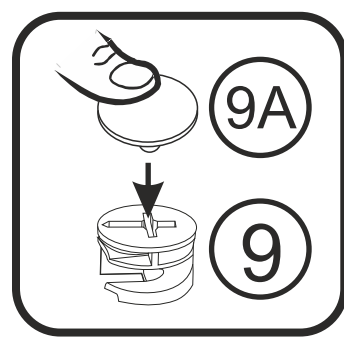
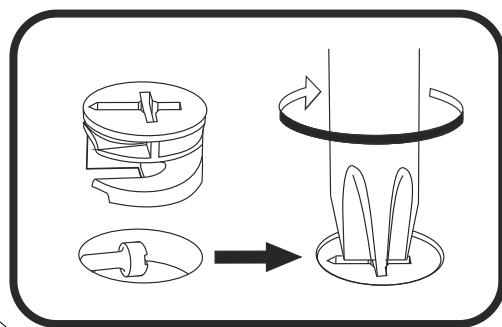
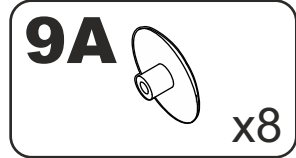
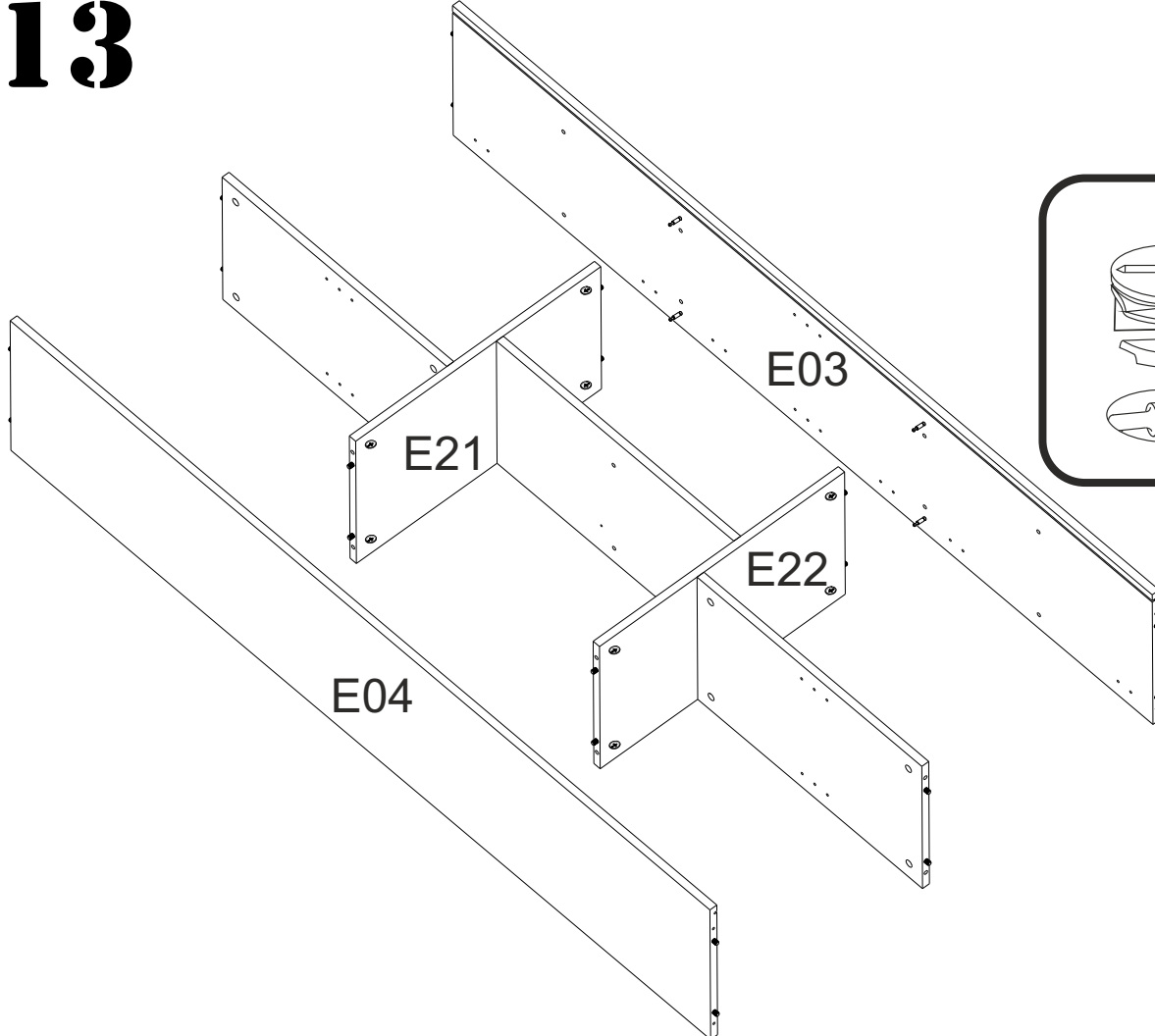

14

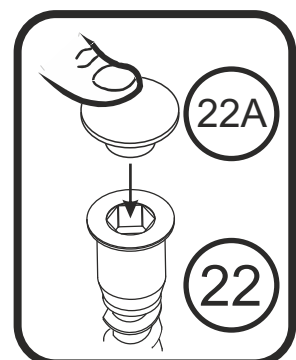
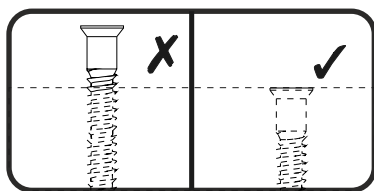
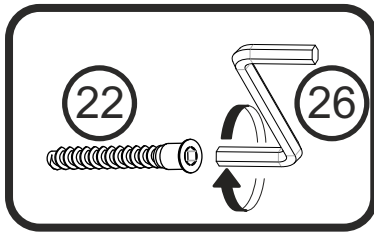
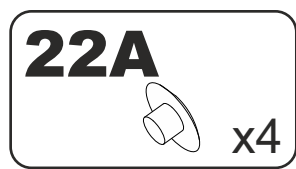
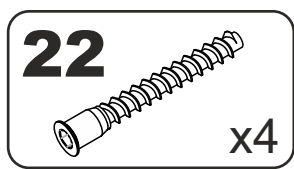
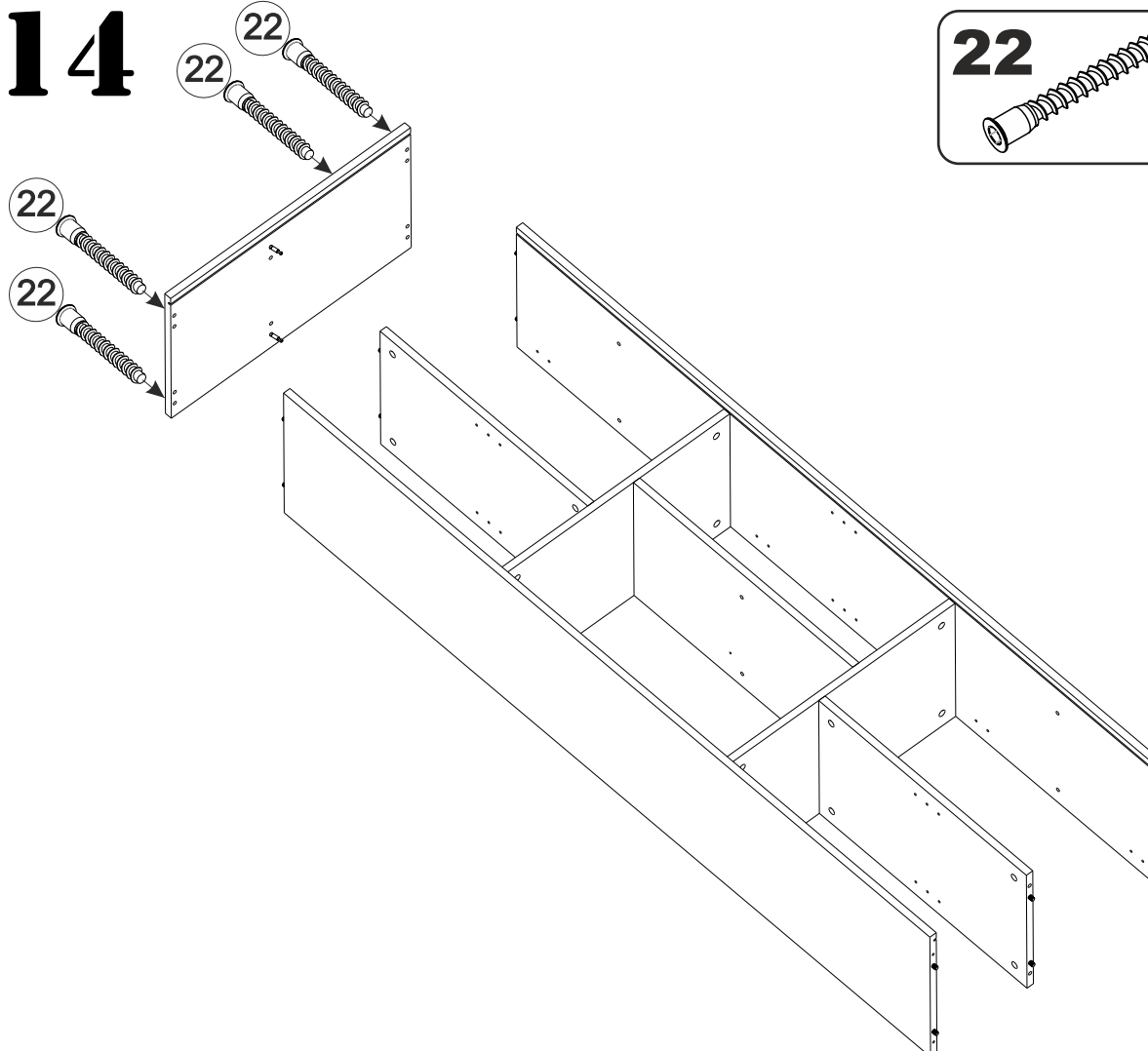

15

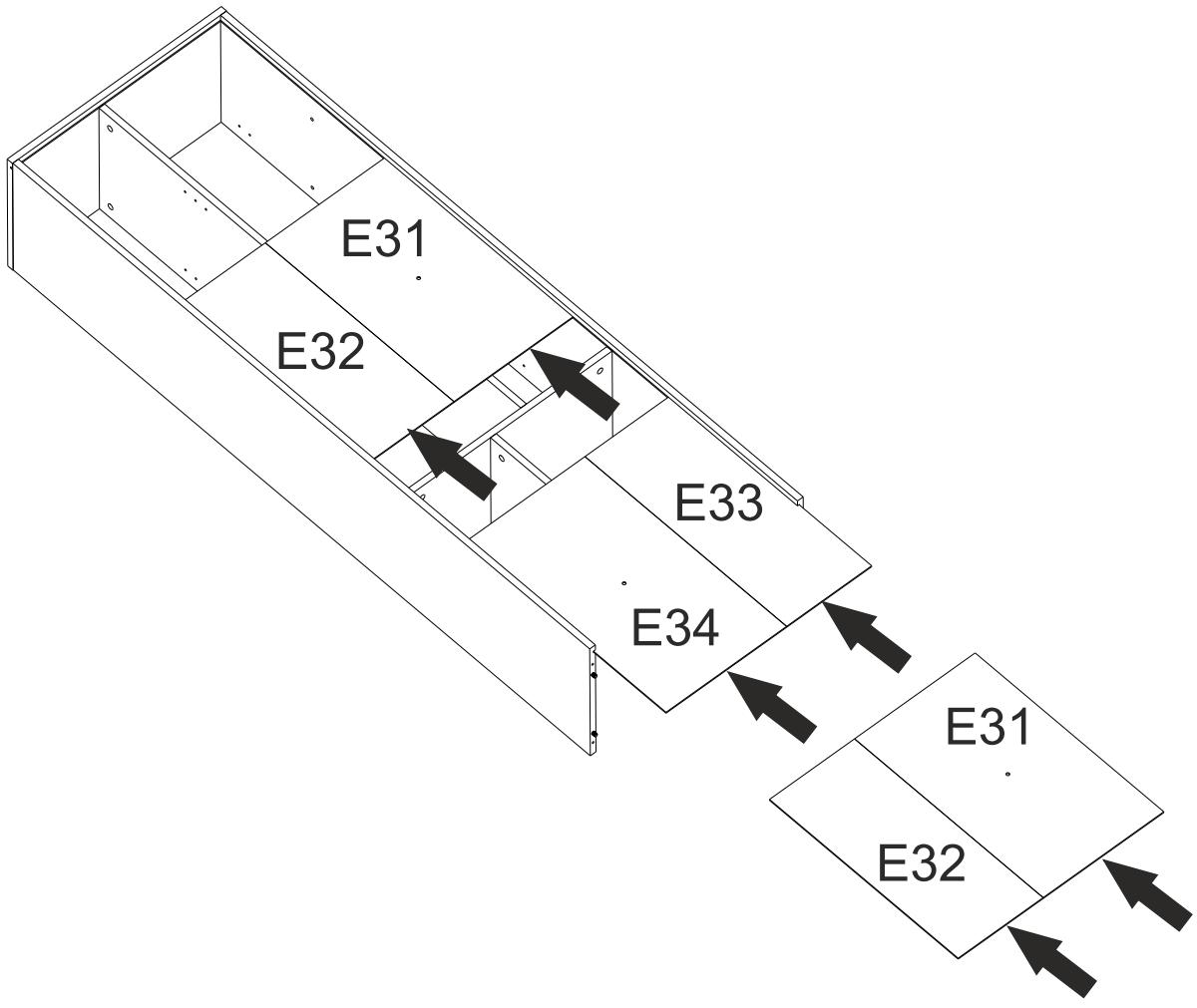

16

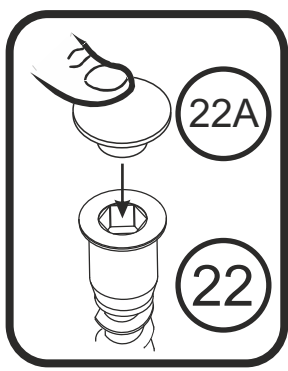
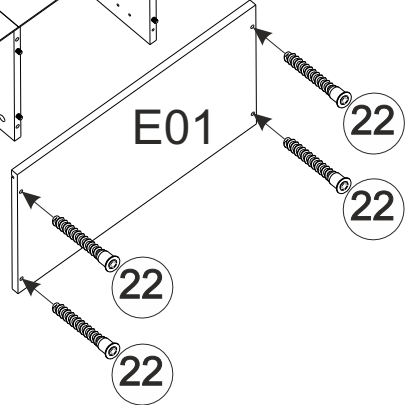
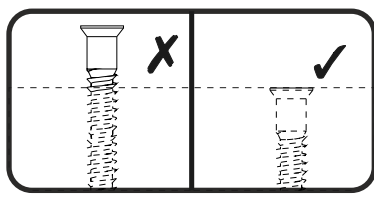
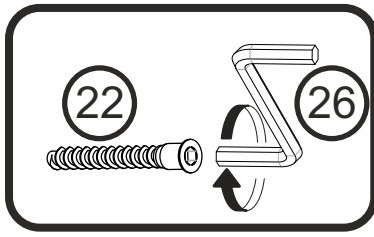
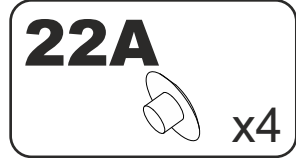
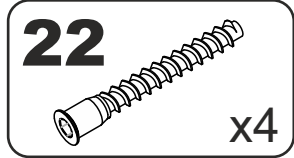
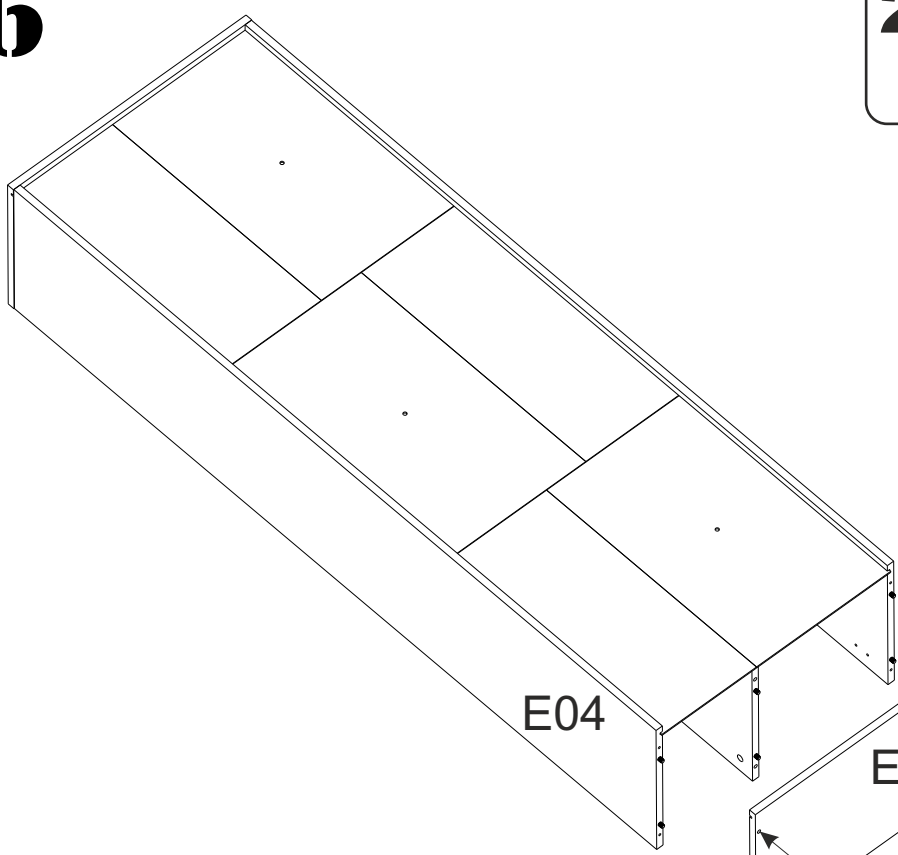

17

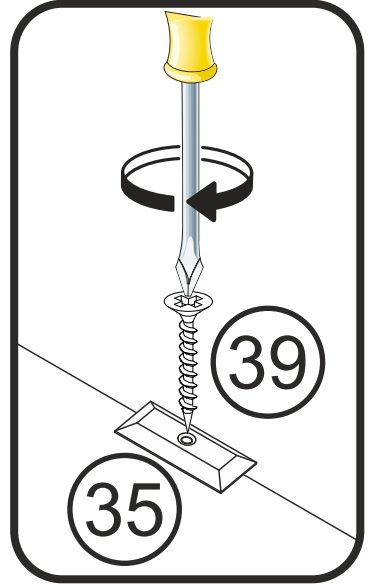
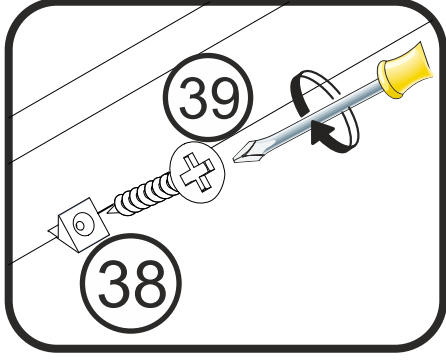
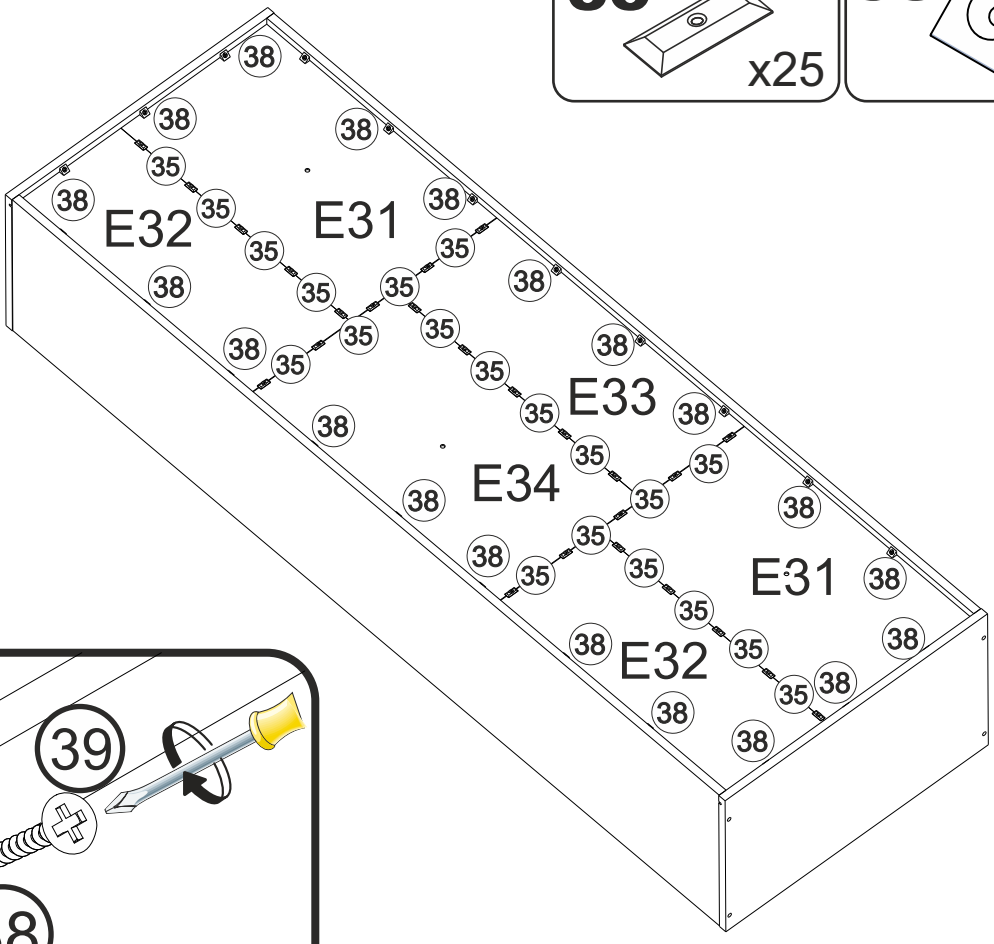
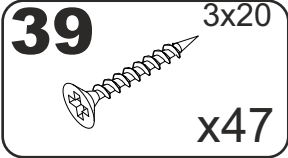
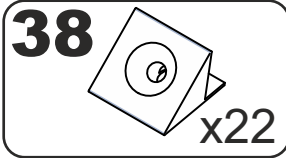
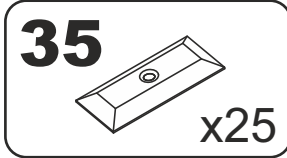

18

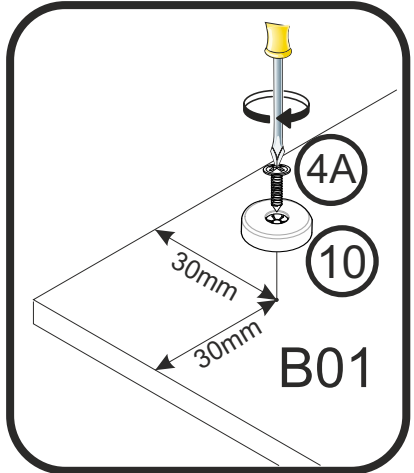
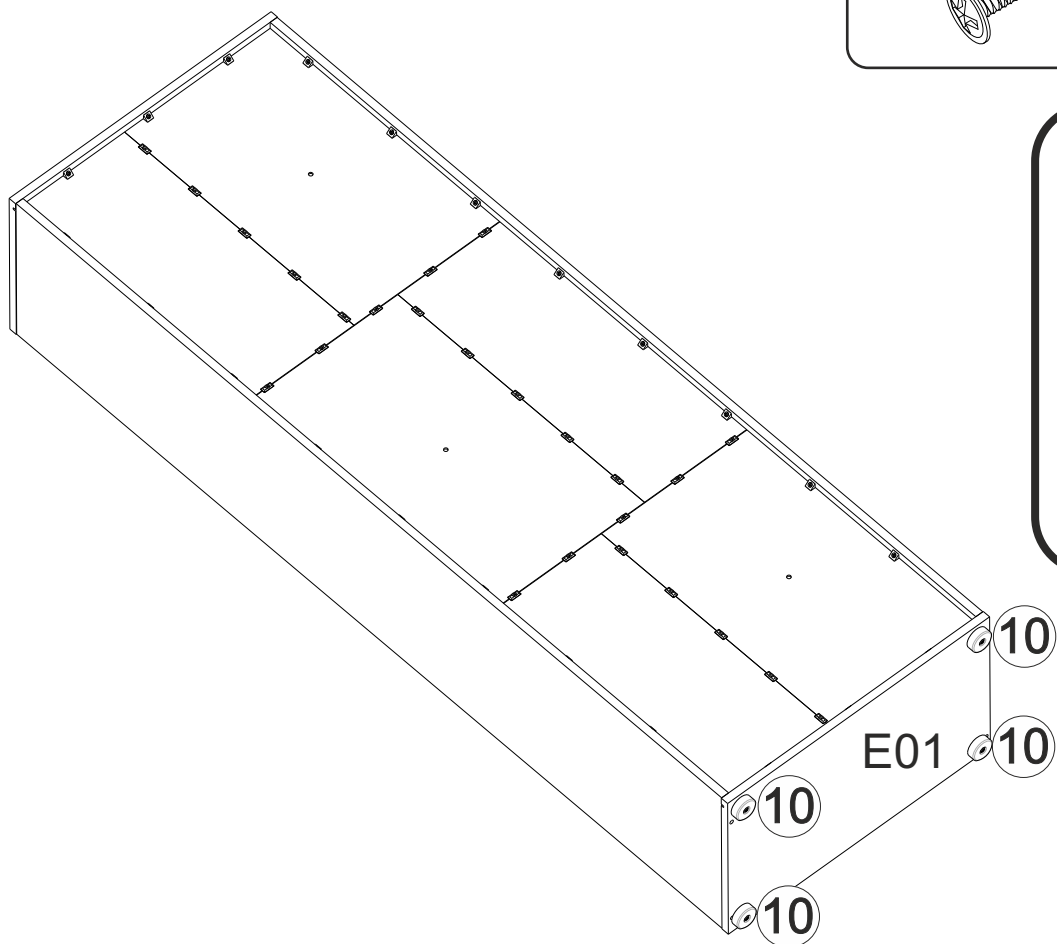
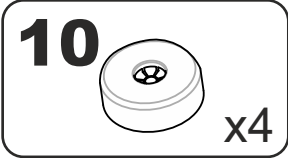
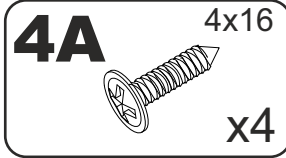

19

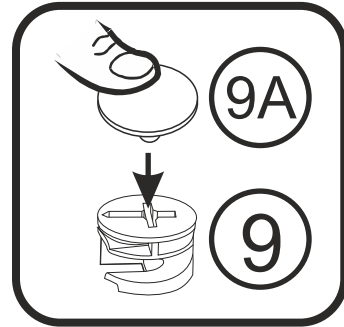
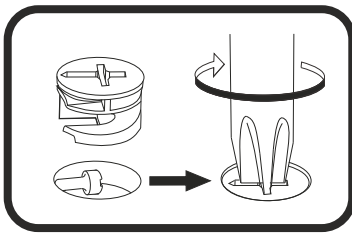
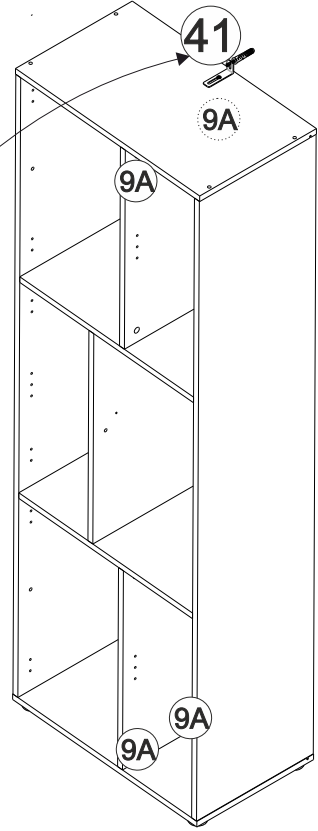
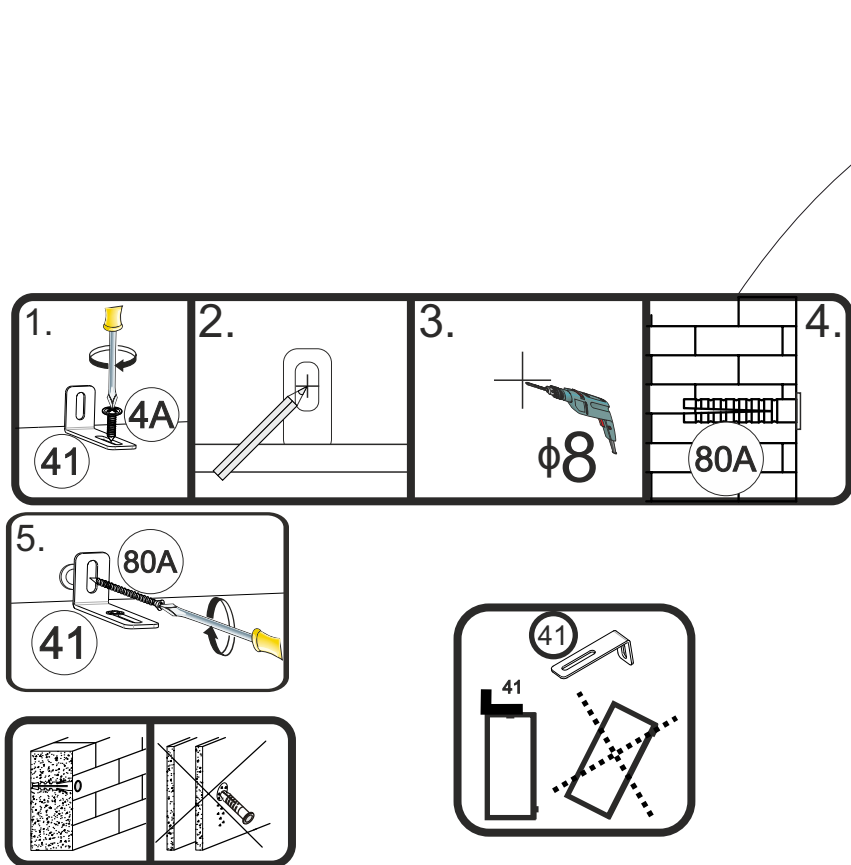
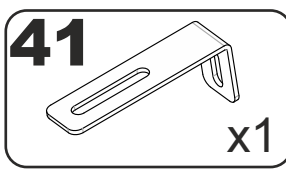
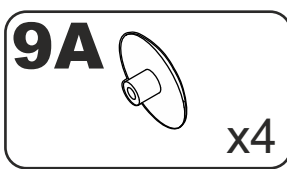
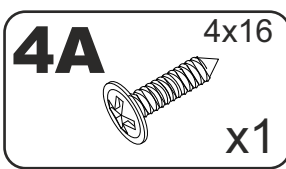

20

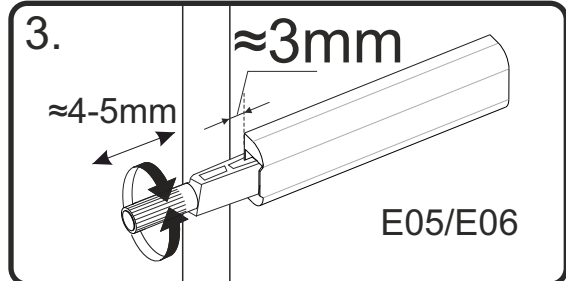
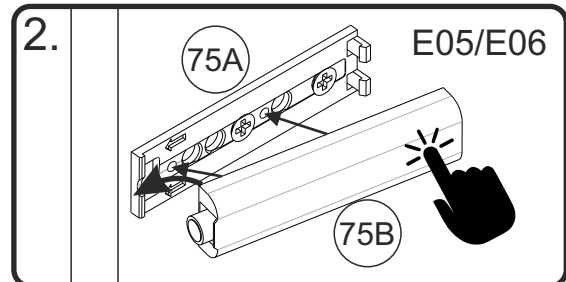
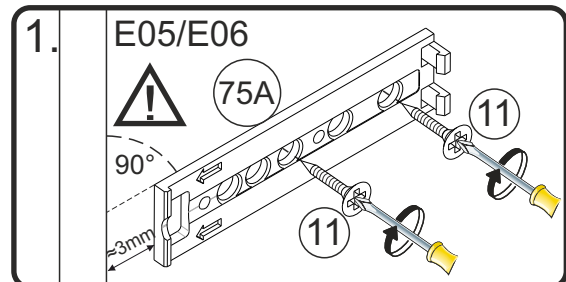
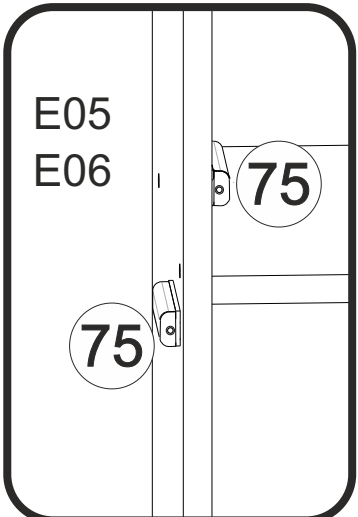
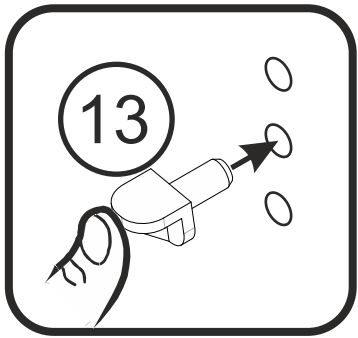
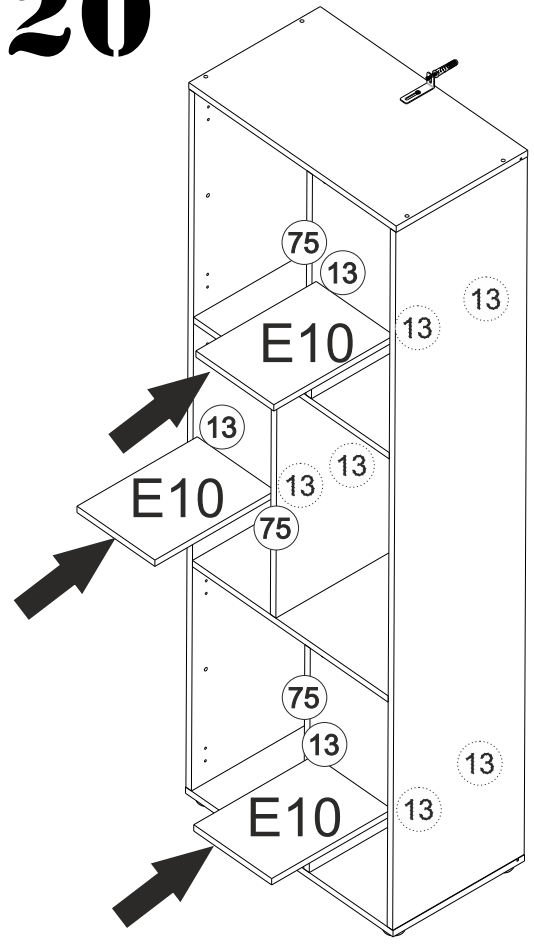
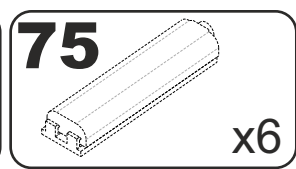
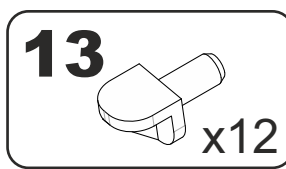
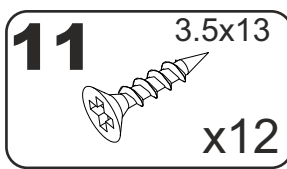

21

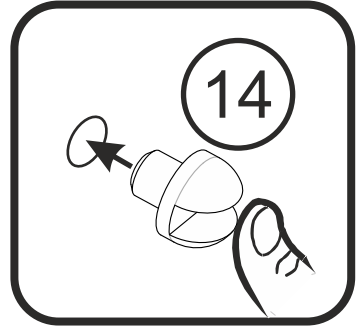
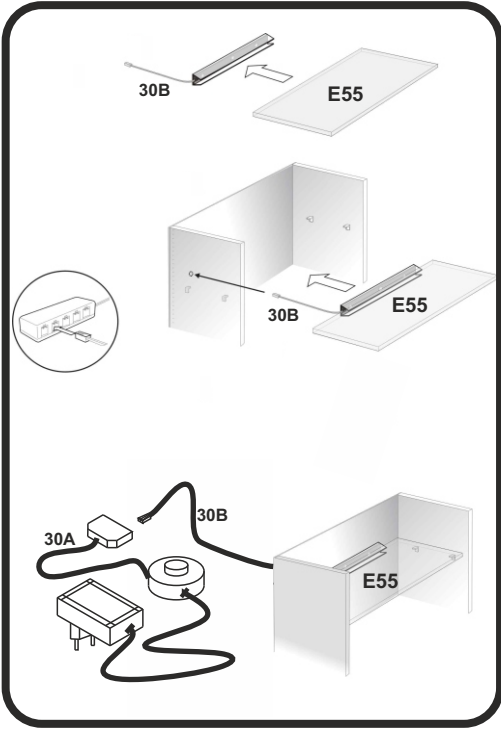
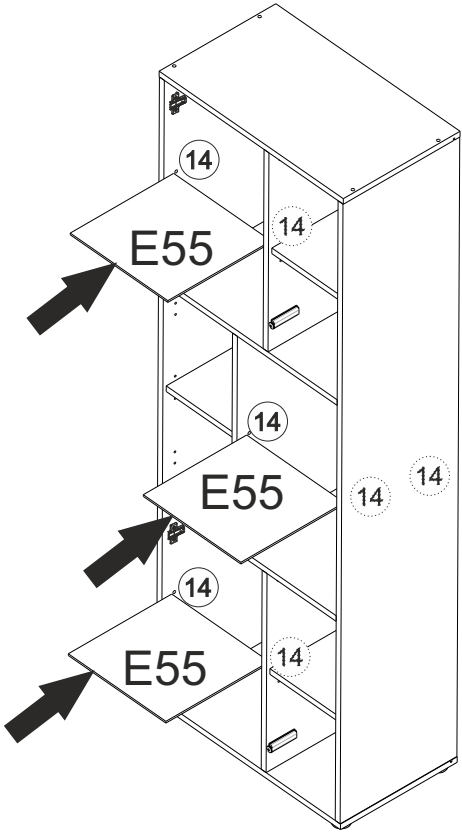
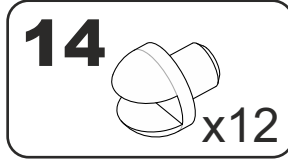
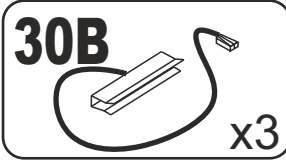
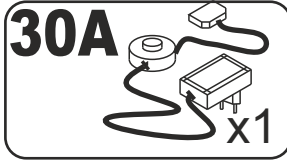

22

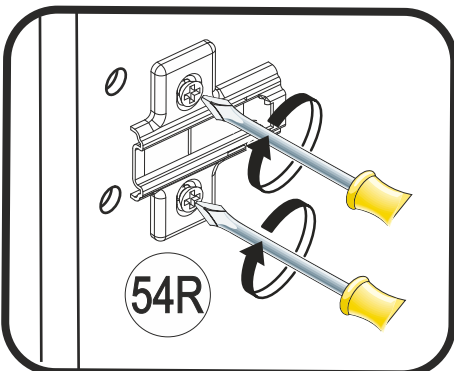
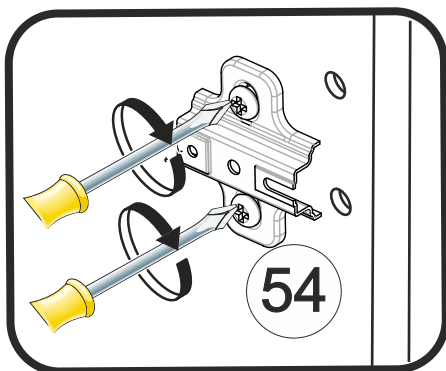
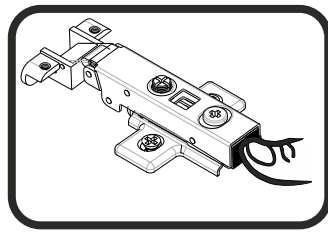
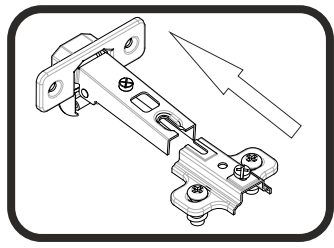
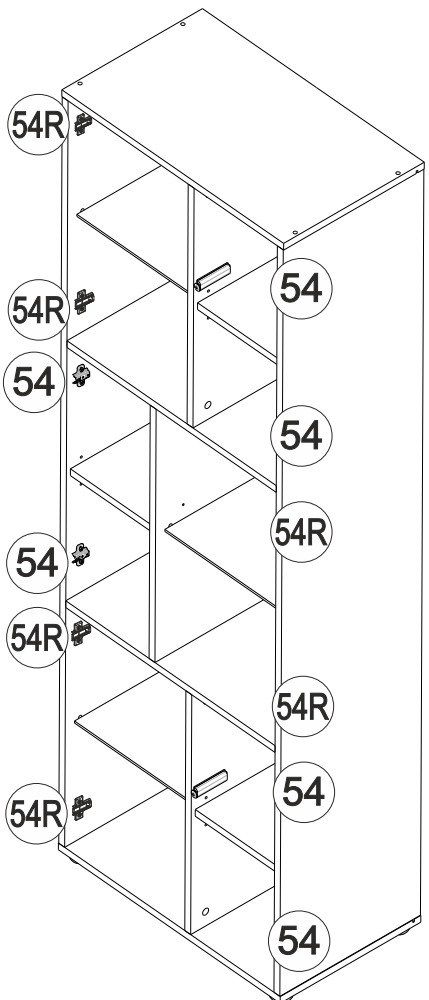
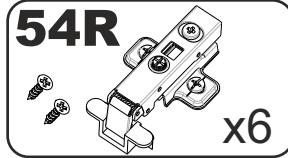
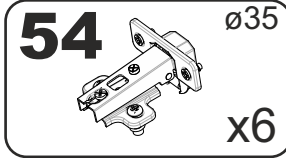

23

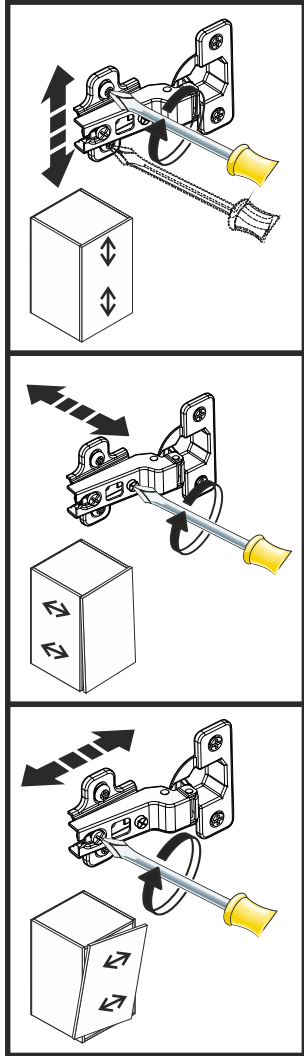
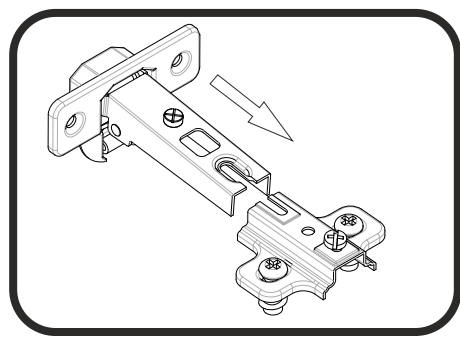
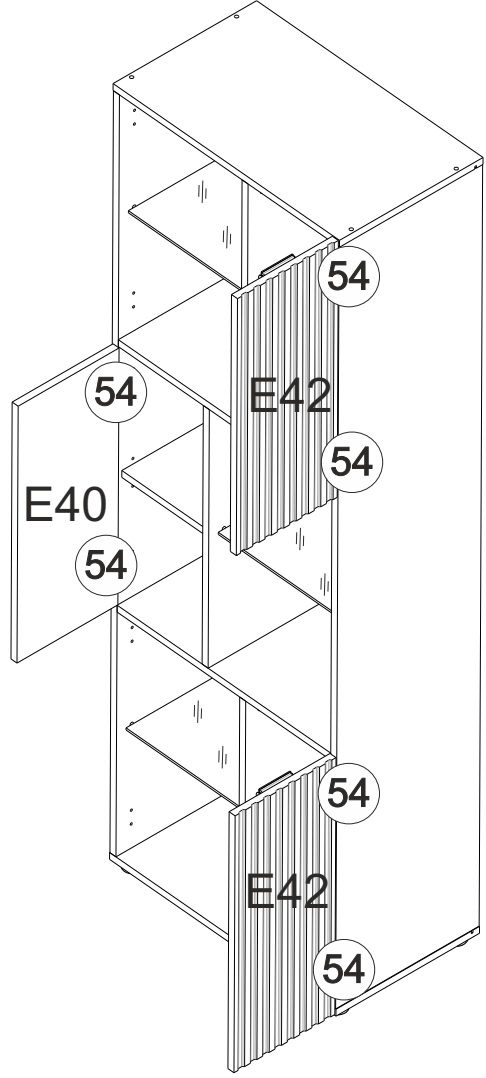

24

