

120 min

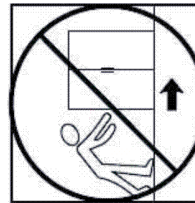

LE TRI + FACILE

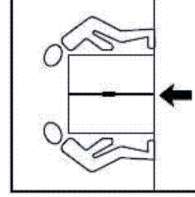
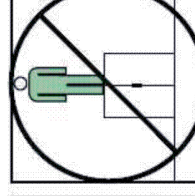
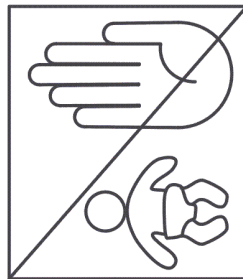
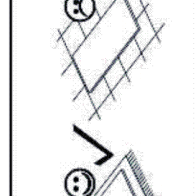
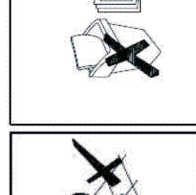
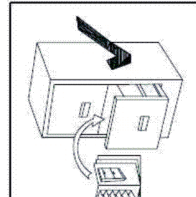
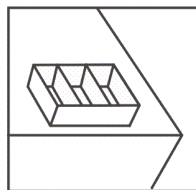
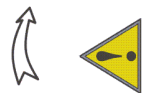
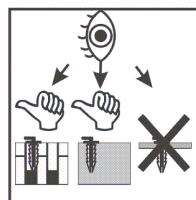
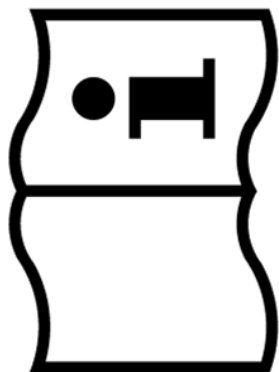
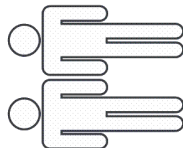
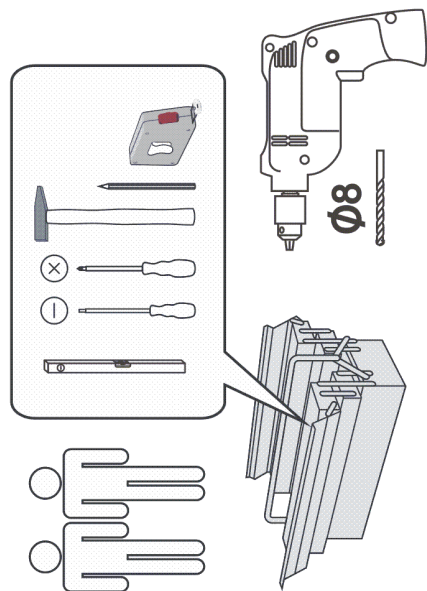

BAC DE TRI



FR

Pensez à donner ou recycler.



Association

ou



Magasin









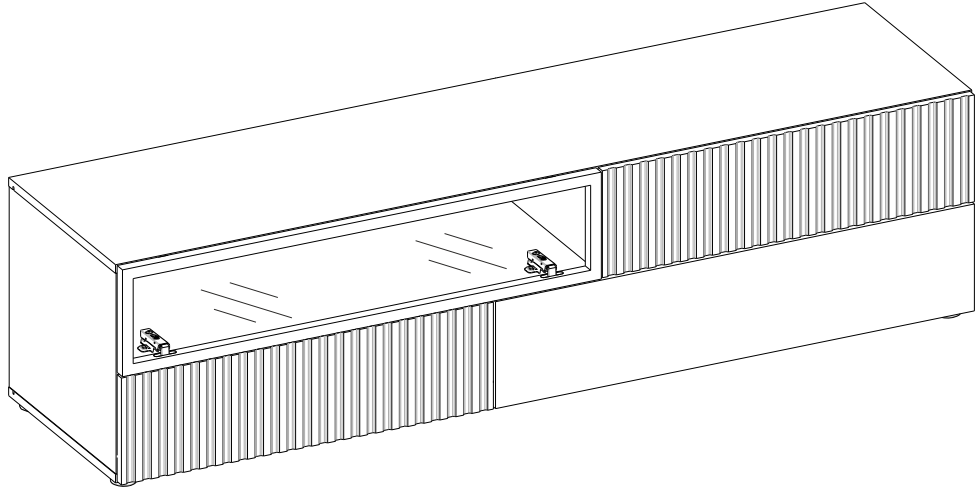
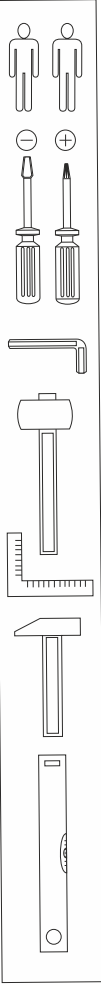

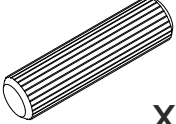
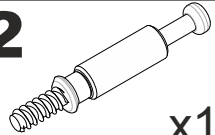
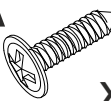
ou

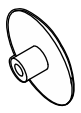

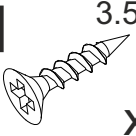
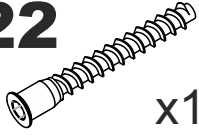
Déchèterie

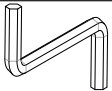
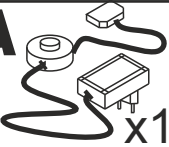
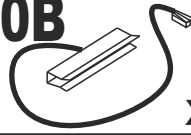
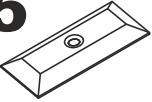
<https://quefairedemesdechets.fr>

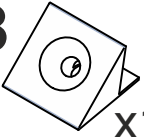
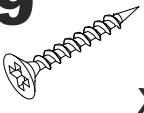
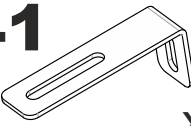
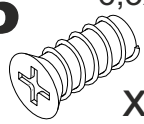
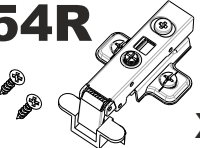
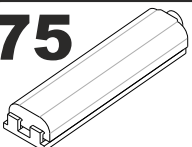
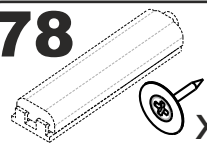
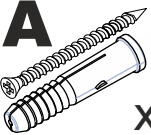
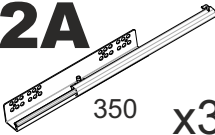
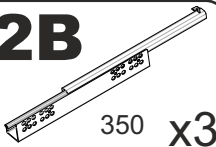
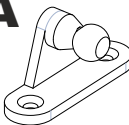
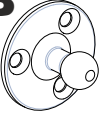

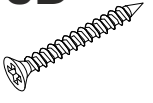
- | | | | | |
|---|--|--|--|---|
| 1  x32 | 2  x18 | 4A 4x16  x15 | 9 ø15  x12 | 9A  x12 |
| 10  x5 | 11 3.5x13  x26 | 22  x14 | 22A  x14 | 24 ø12  x6 |
| 26  x1 | 30A  x1 | 30B  x1 | 35  x8 | 37  x4 |
| 38  x17 | 39 3x20  x49 | 41  x1 | 45 6,3x13  x12 | 54R  x2 |
| 75  x1 | 78  x3 | 80A  x1 | 92A 350  x3 | 92B 350  x3 |
| 76A  x1 | 76B  x1 | 76C  x1 | 76D  x5 | |



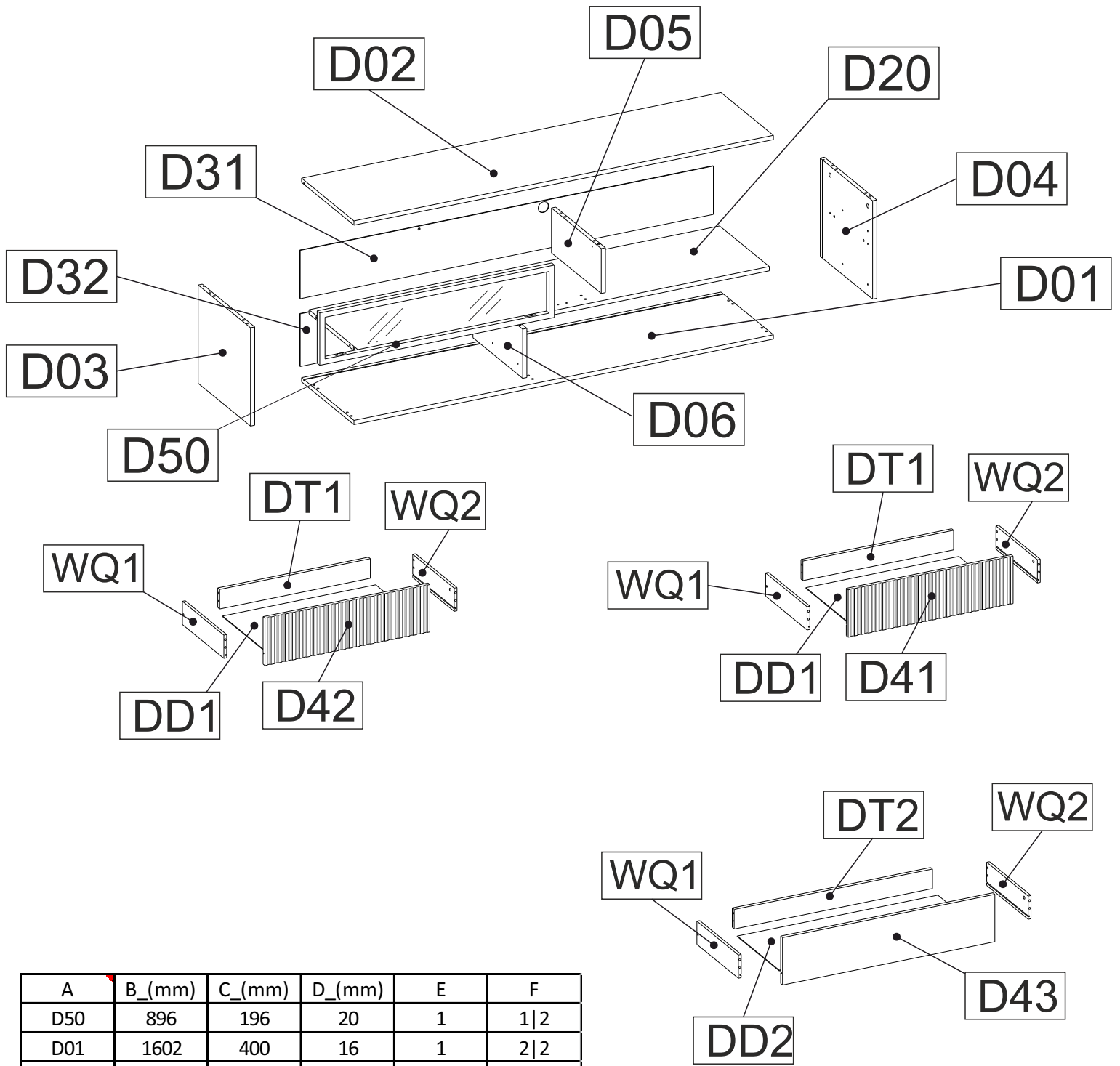

| A | B_(mm) | C_(mm) | D_(mm) | E | F |
|-----|--------|--------|--------|---|-----|
| D50 | 896 | 196 | 20 | 1 | 1 2 |
| D01 | 1602 | 400 | 16 | 1 | 2 2 |
| D02 | 1602 | 400 | 16 | 1 | 2 2 |
| D03 | 400 | 368 | 16 | 1 | 1 2 |
| D04 | 400 | 368 | 16 | 1 | 1 2 |
| D05 | 168 | 380 | 16 | 1 | 1 2 |
| D06 | 184 | 380 | 16 | 1 | 1 2 |
| D20 | 1568 | 380 | 16 | 1 | 2 2 |
| D31 | 1578 | 181 | 3 | 1 | 2 2 |
| D32 | 1578 | 197 | 3 | 1 | 2 2 |
| D41 | 196 | 696 | 16 | 1 | 1 2 |
| D42 | 196 | 696 | 16 | 1 | 1 2 |
| D43 | 196 | 896 | 16 | 1 | 1 2 |
| DD1 | 646 | 353 | 3 | 2 | 1 2 |
| DD2 | 846 | 353 | 3 | 1 | 1 2 |
| DT1 | 636 | 81 | 16 | 2 | 1 2 |
| DT2 | 836 | 81 | 16 | 1 | 1 2 |
| WQ1 | 350 | 96 | 12 | 3 | 1 2 |
| WQ2 | 350 | 96 | 12 | 3 | 1 2 |

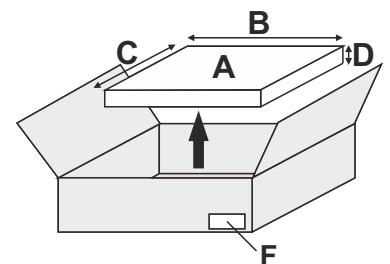

1

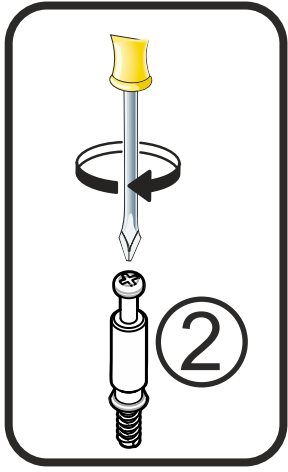
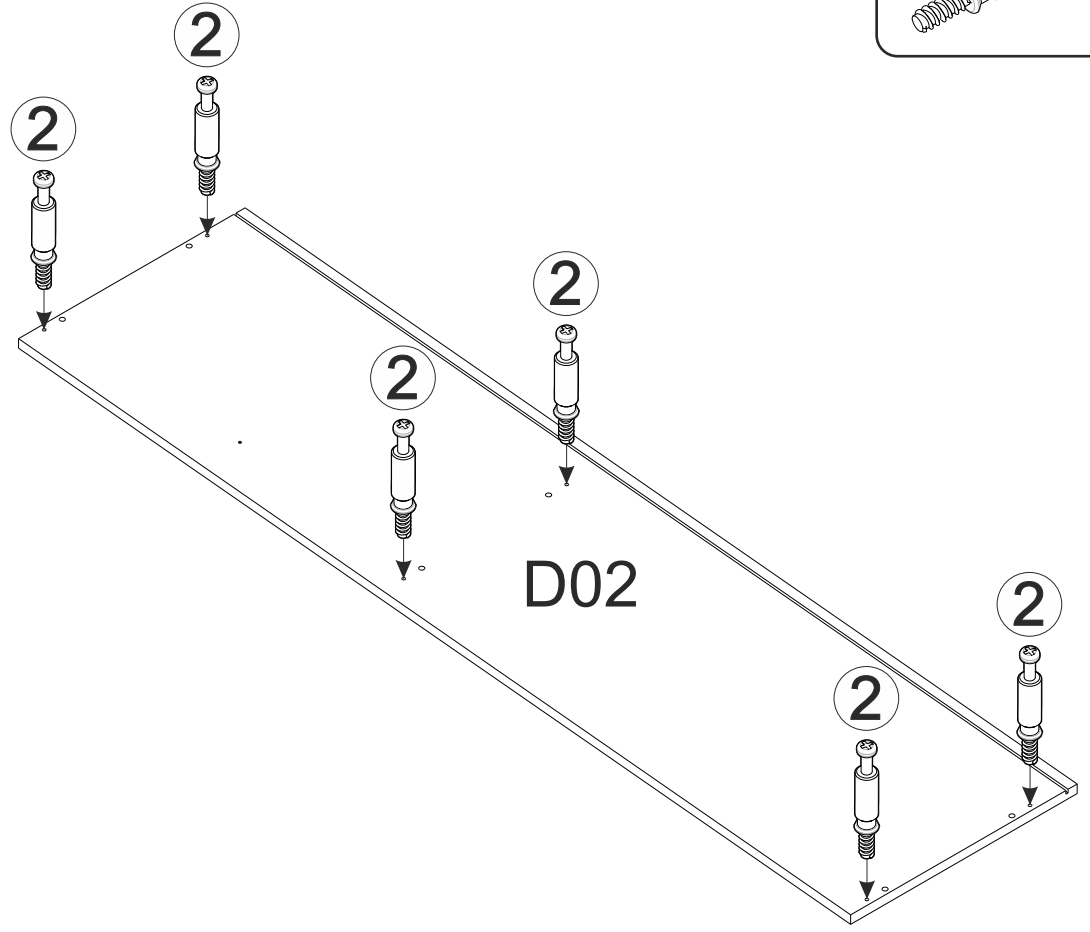
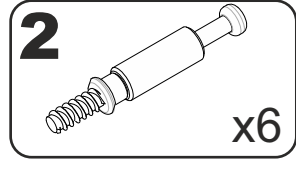

2

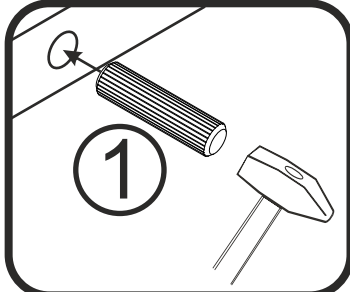
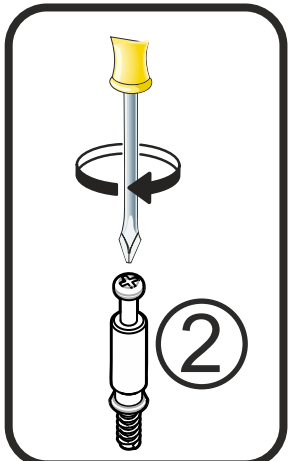
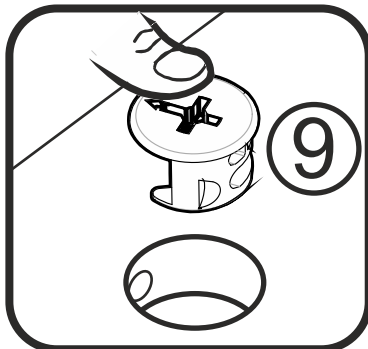
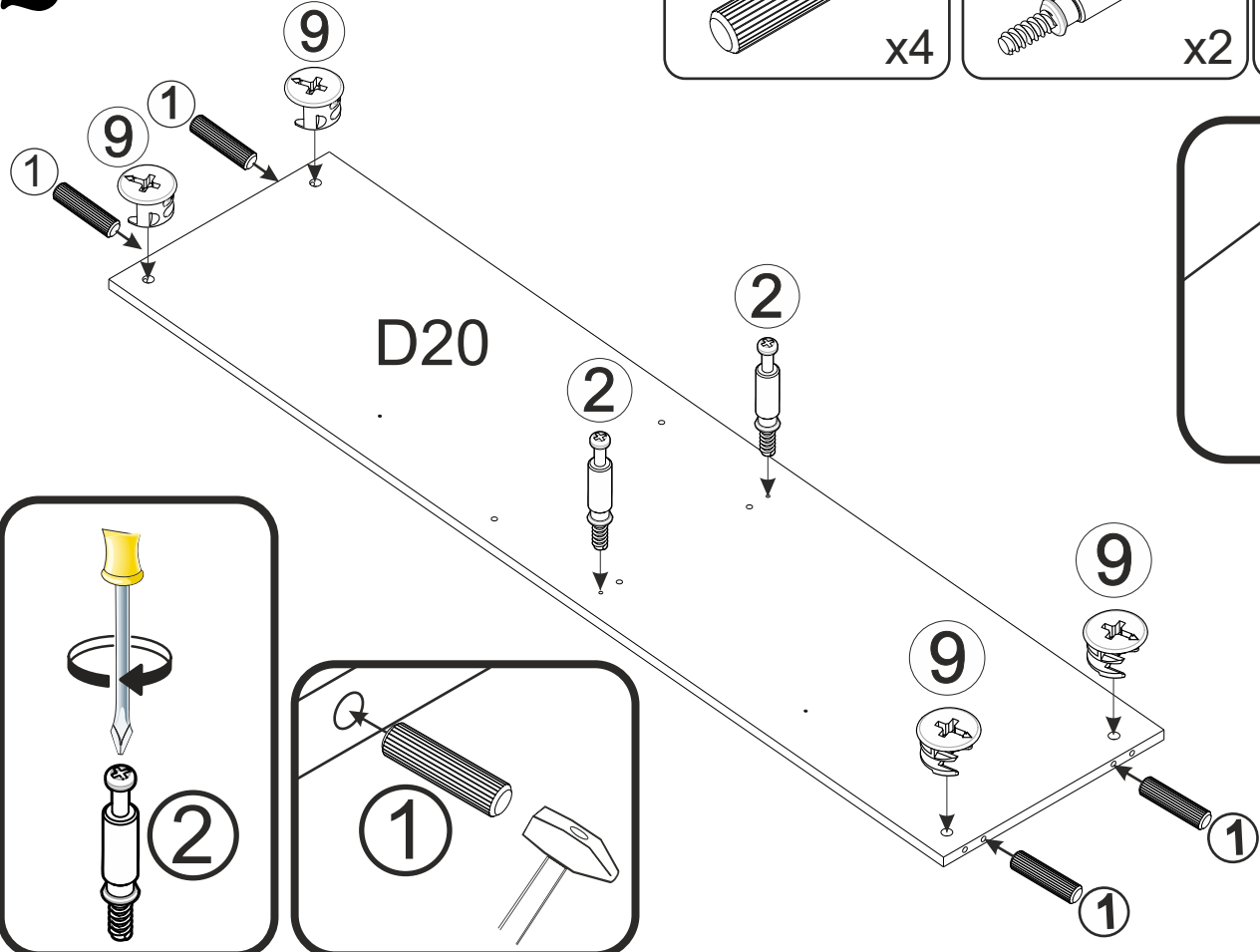
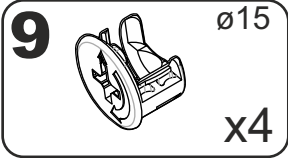
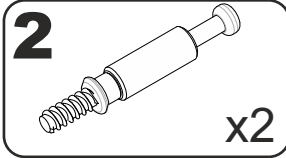
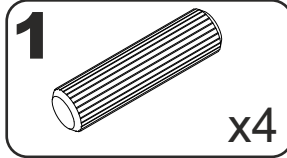

3

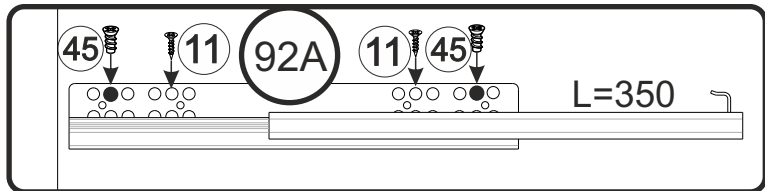
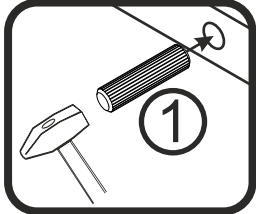
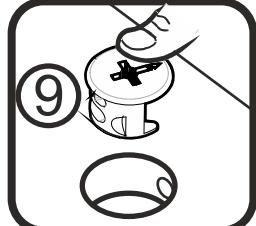
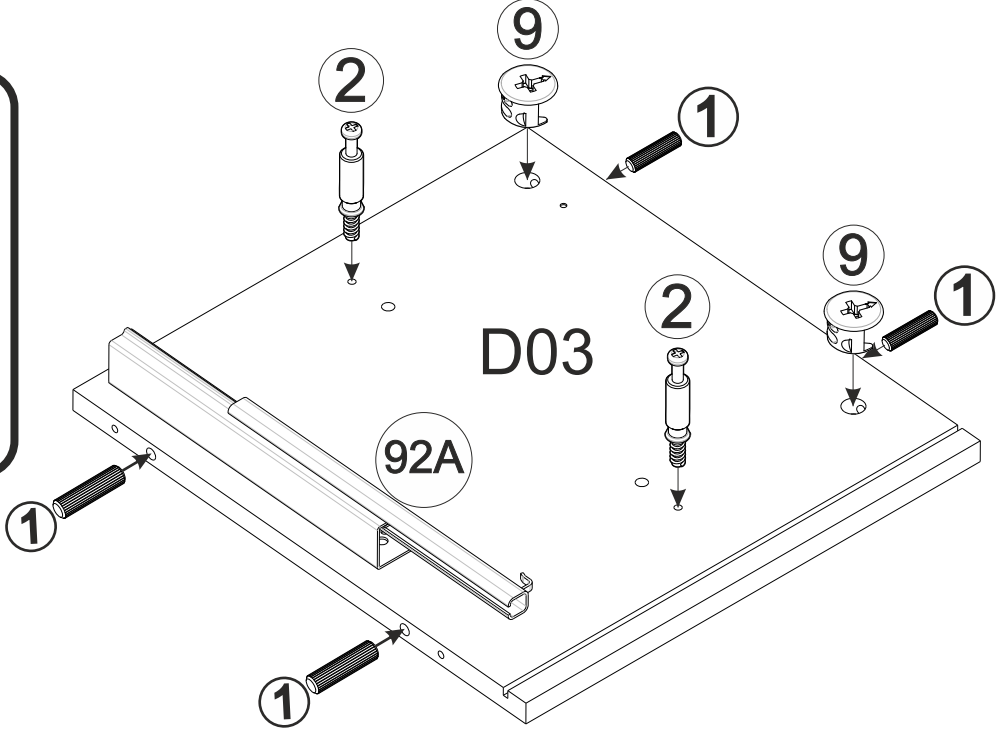
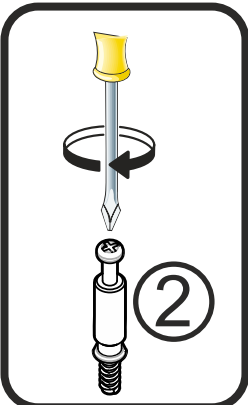
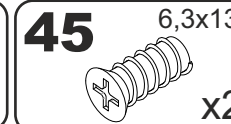
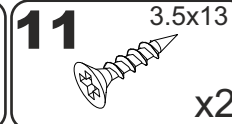
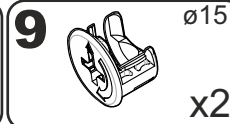
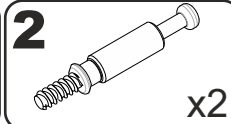
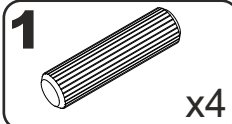

4

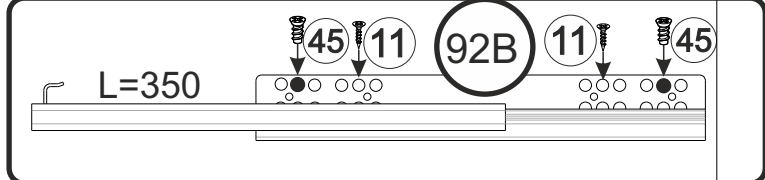
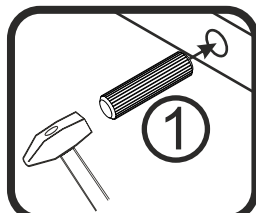
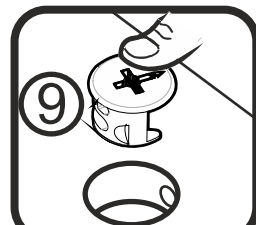
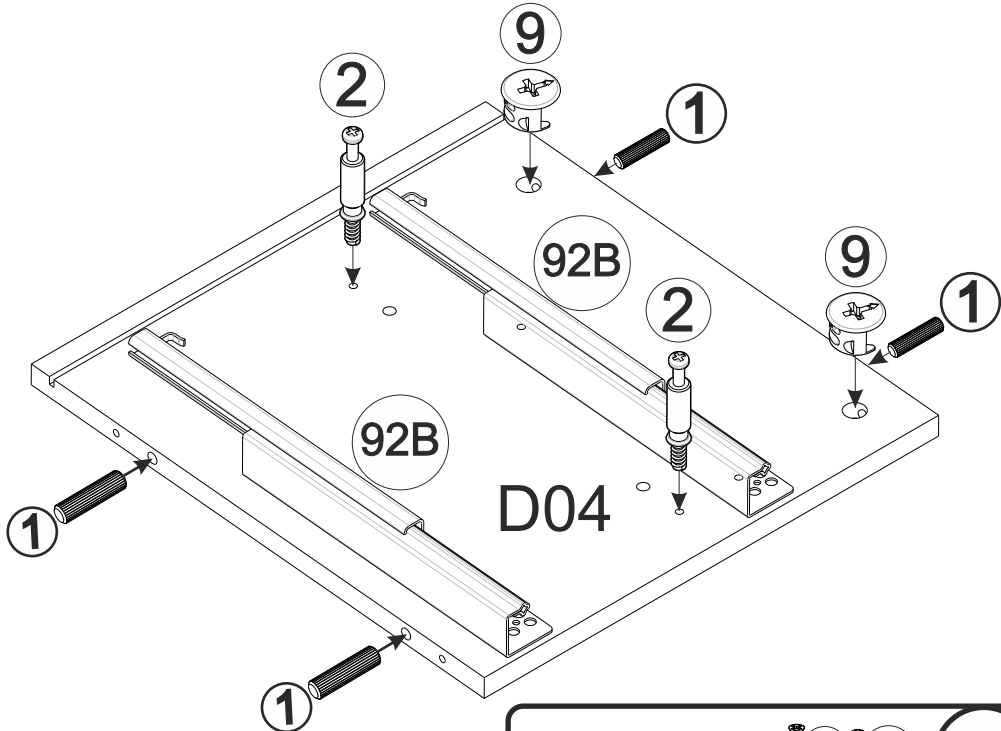
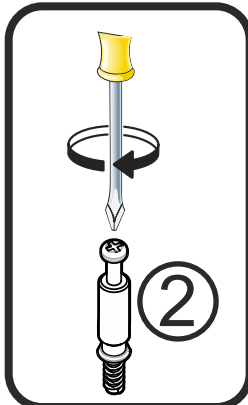
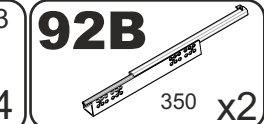
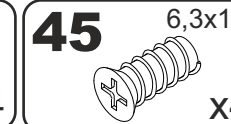
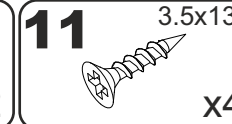
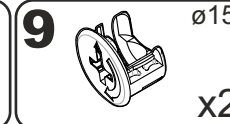
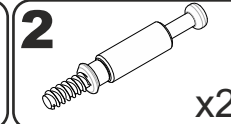
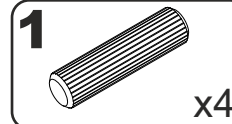

5

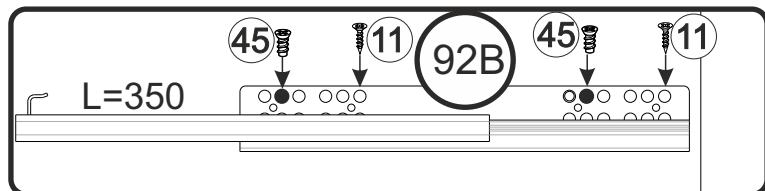
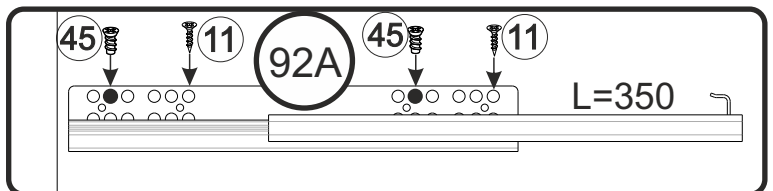
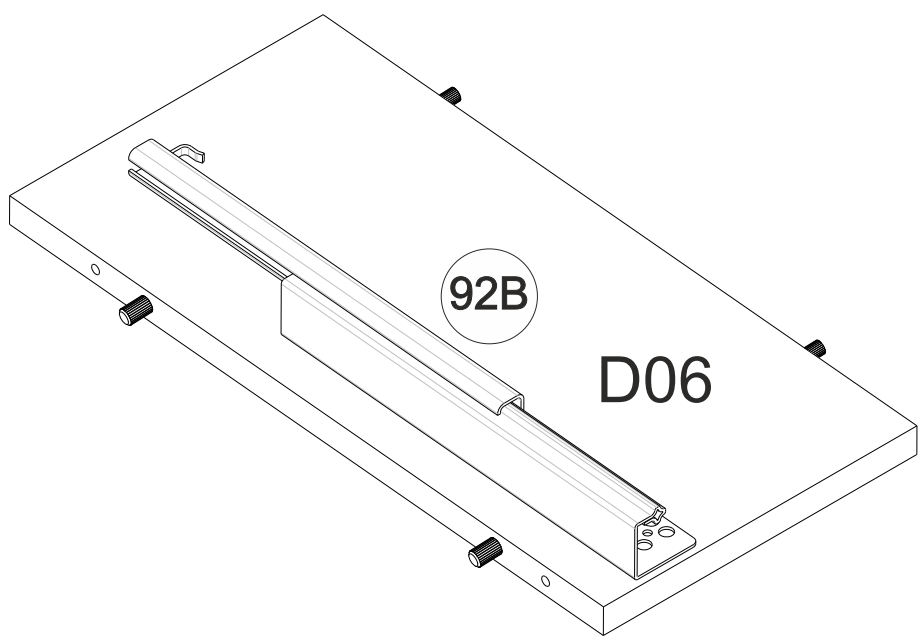
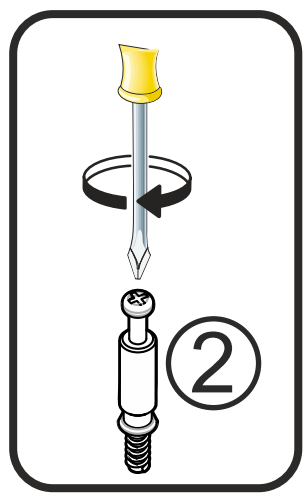
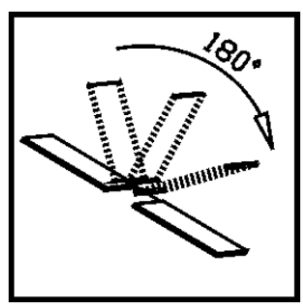
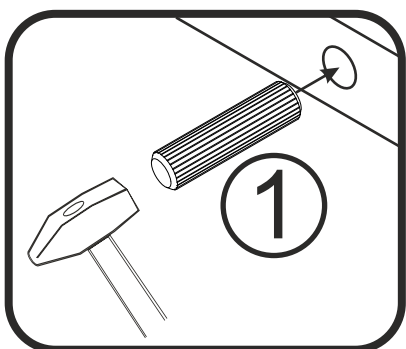
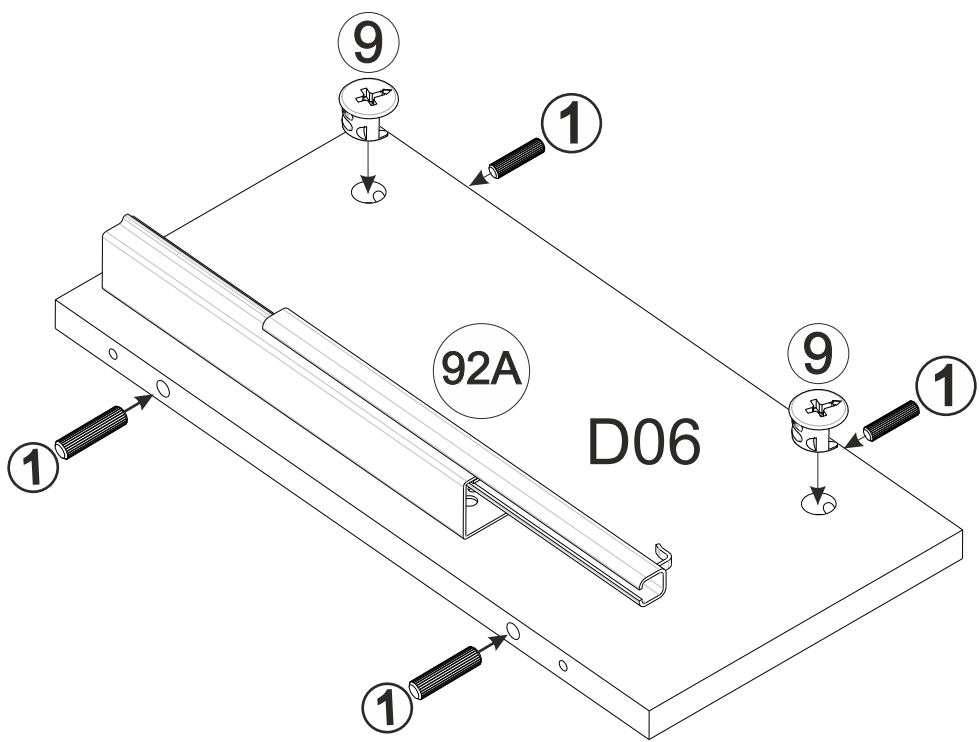
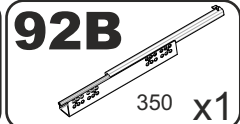
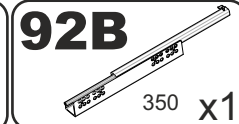
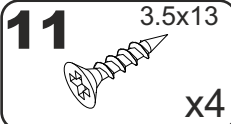
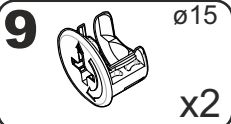
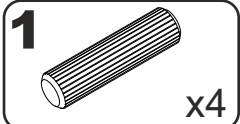

6

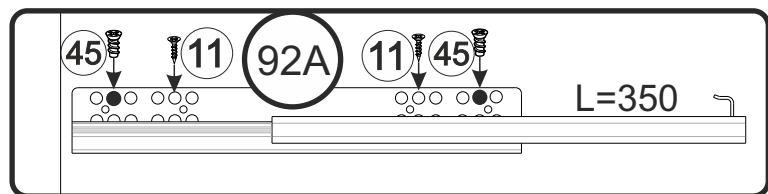
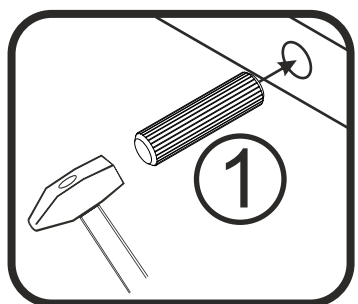
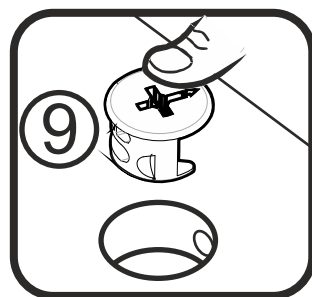
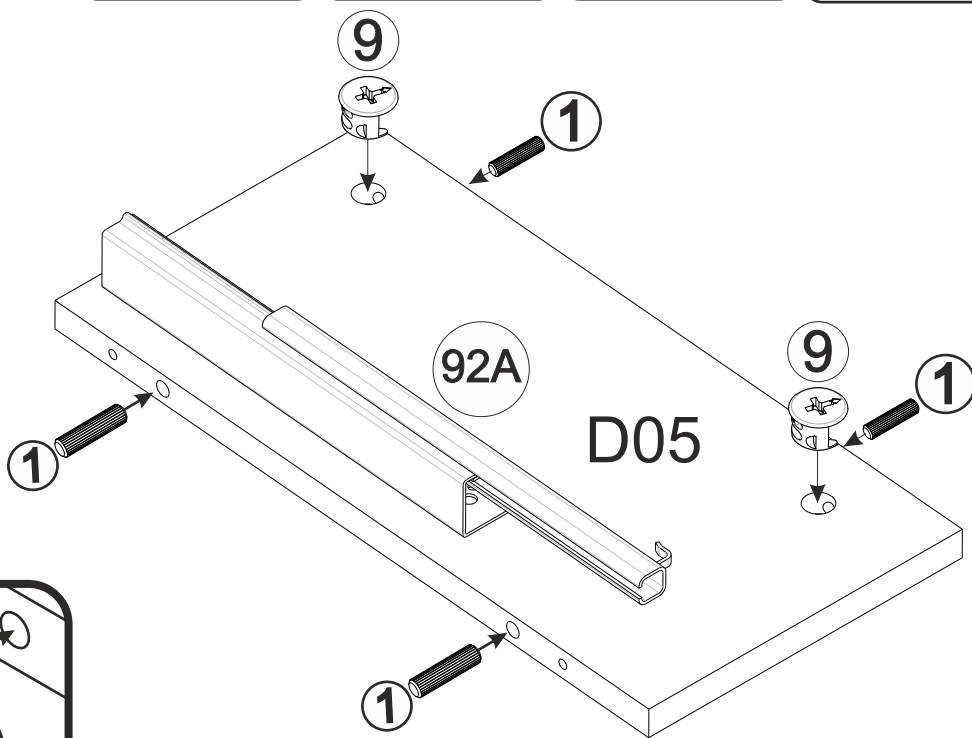
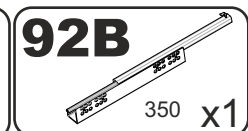
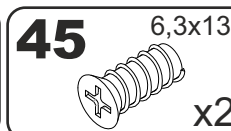
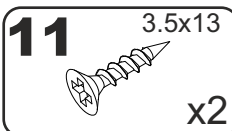
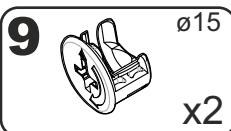
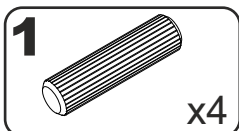

7

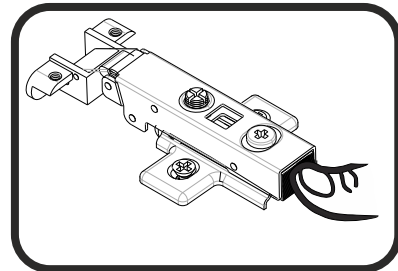
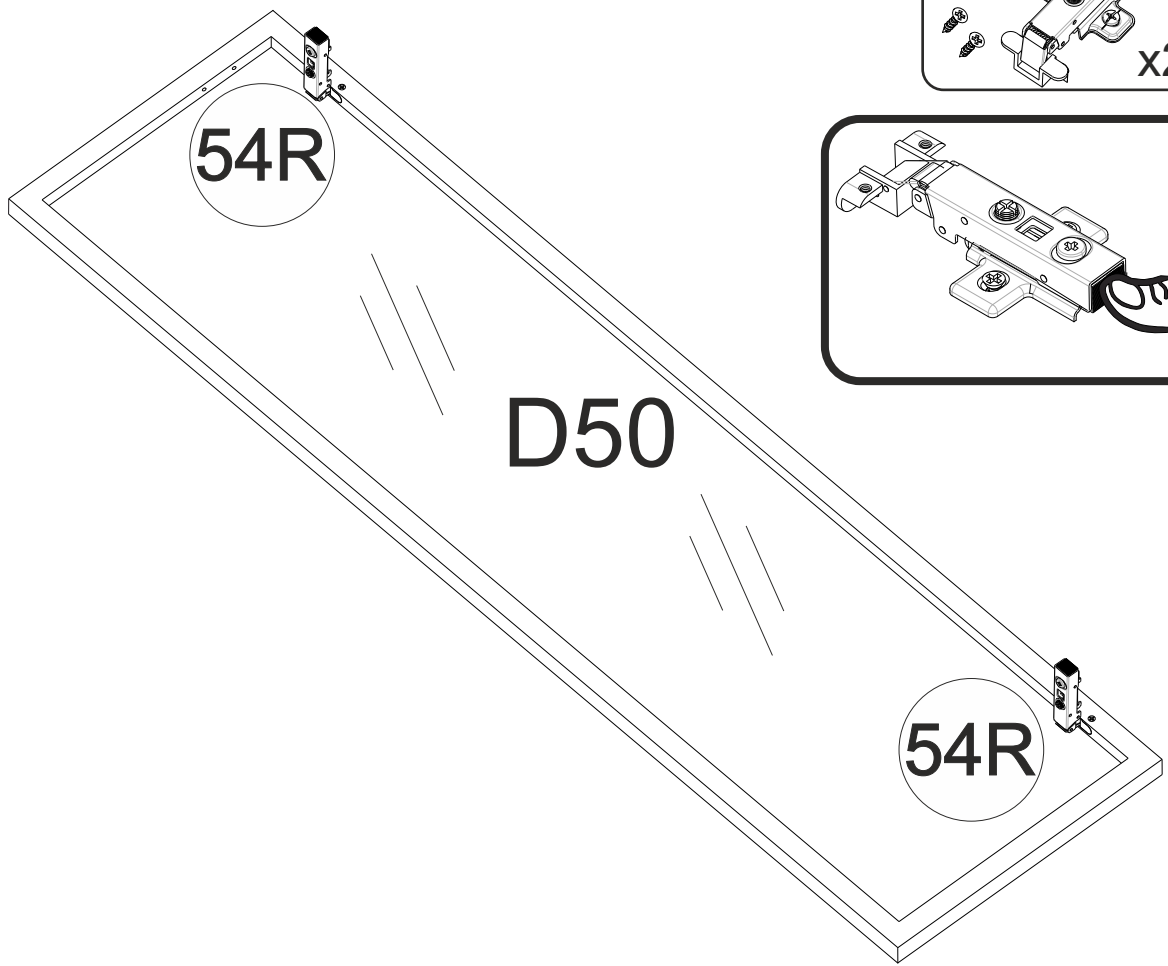
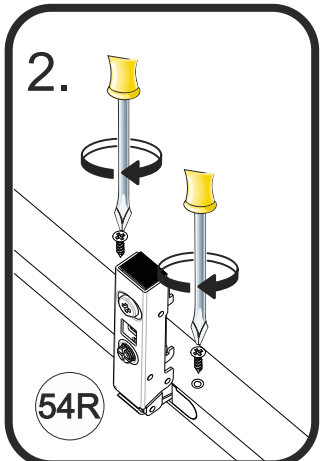
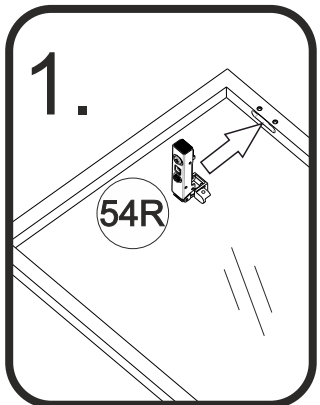
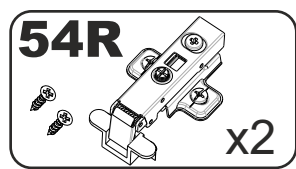

8

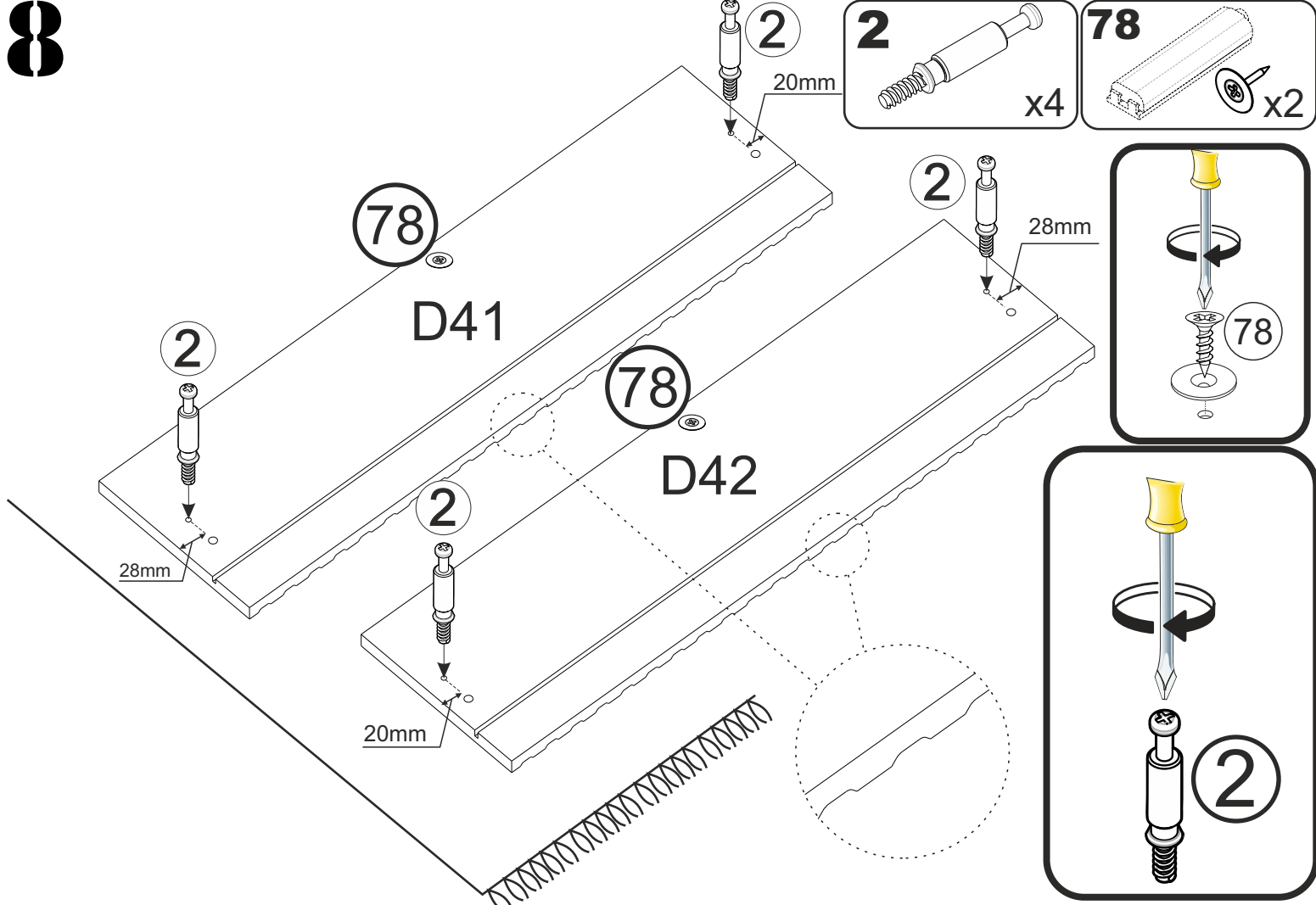

9

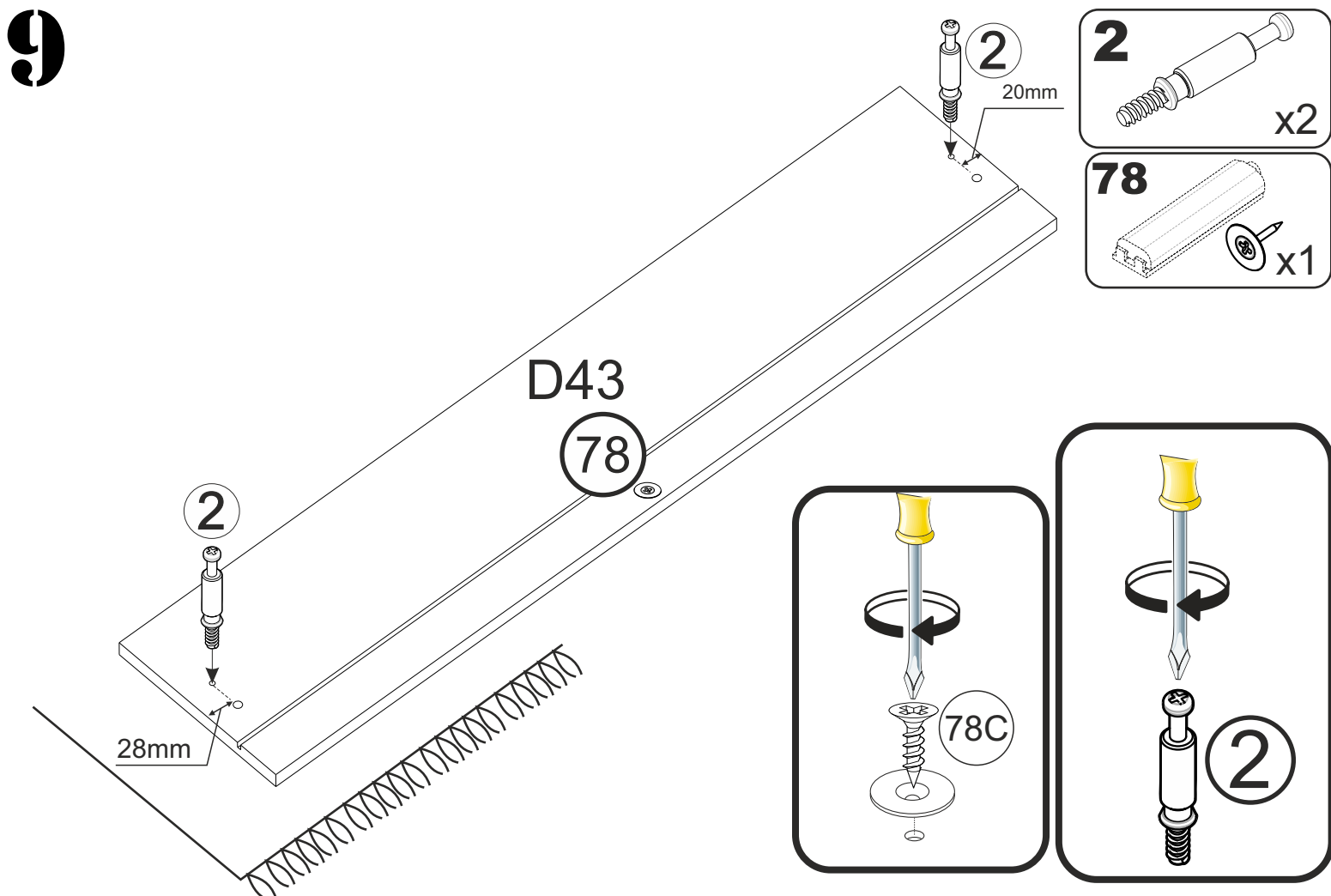

10

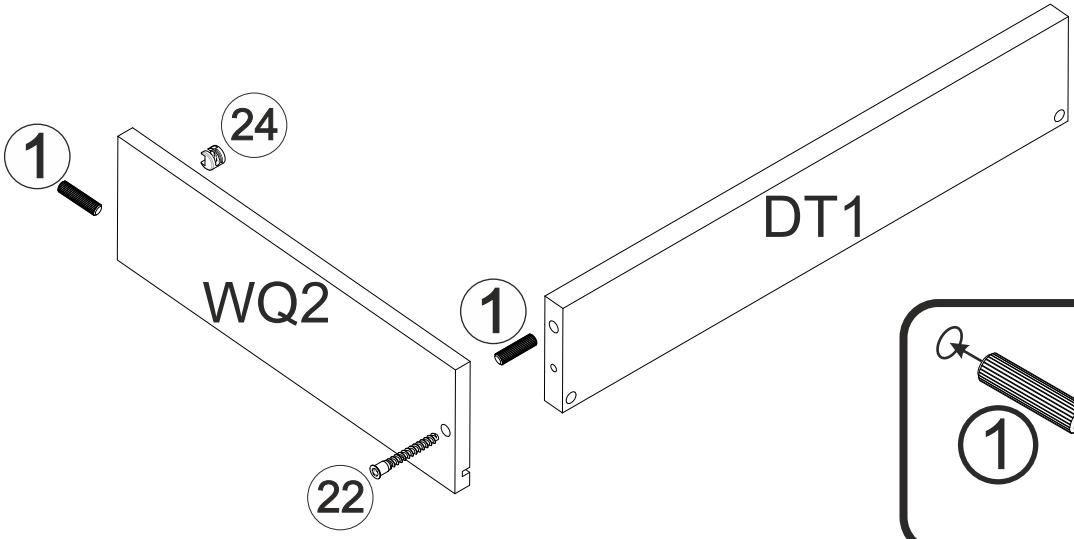
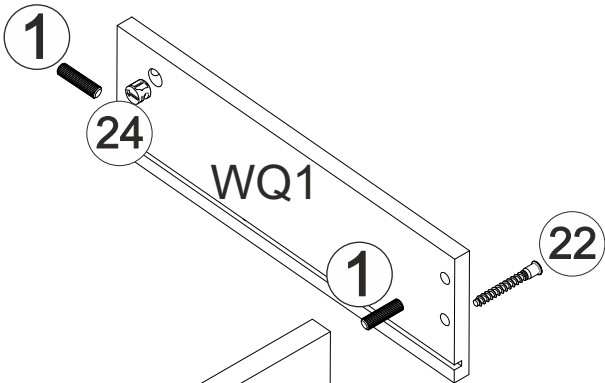
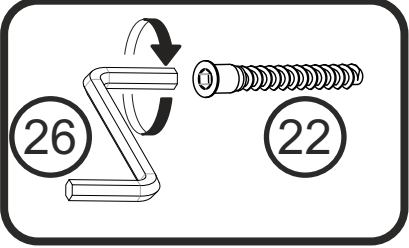
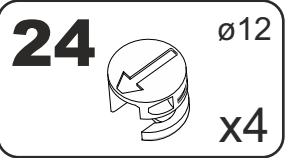
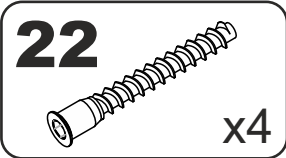
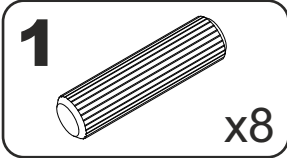

x2

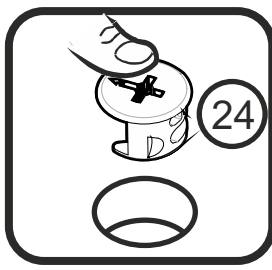
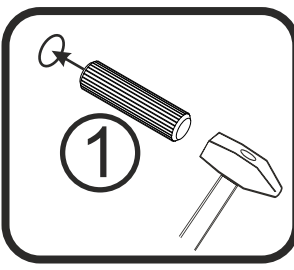

11

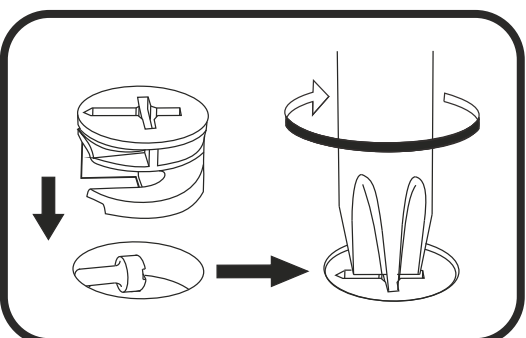
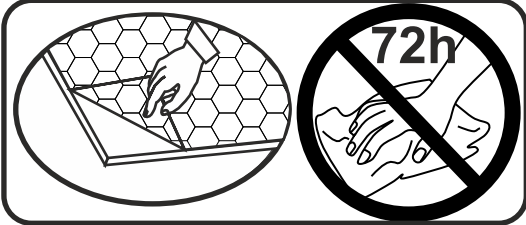
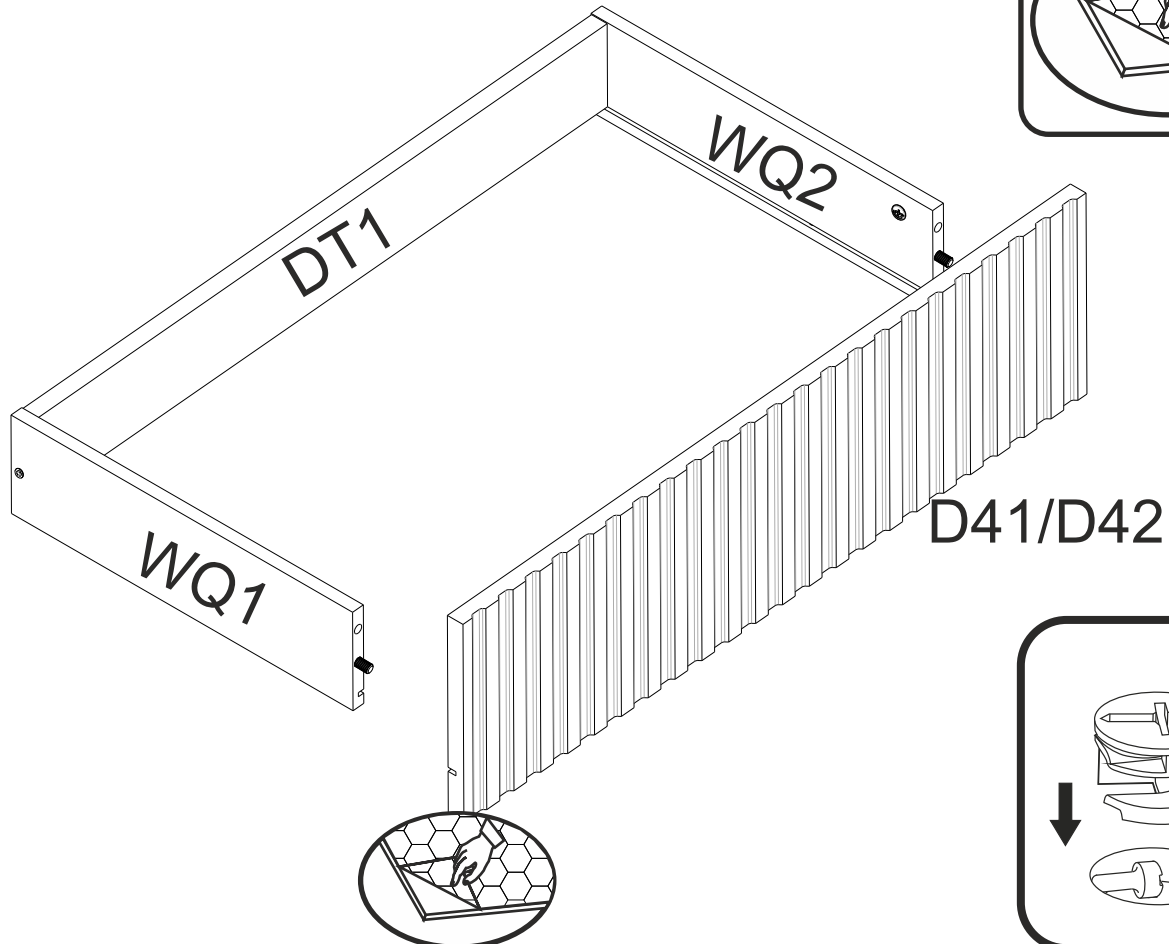

12

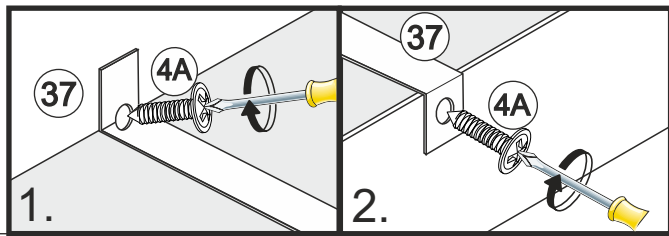
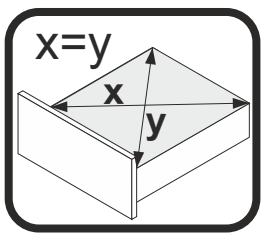
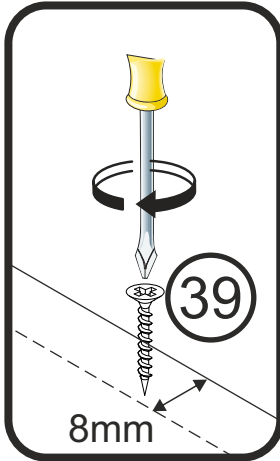
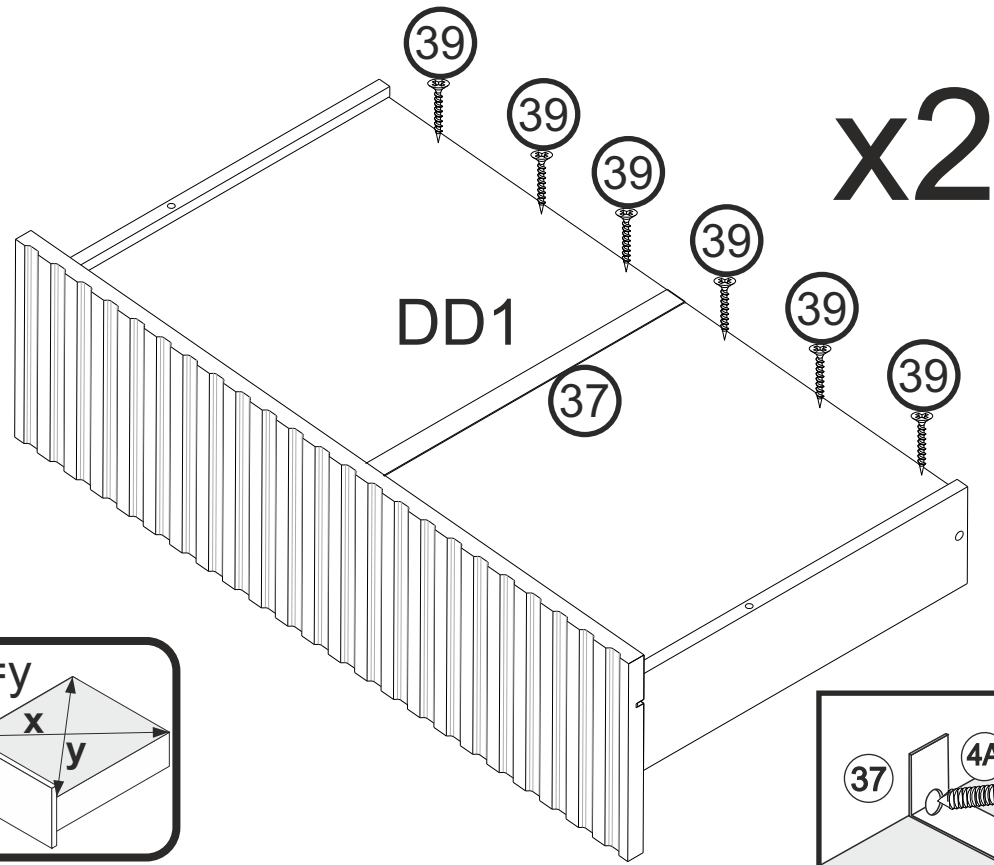
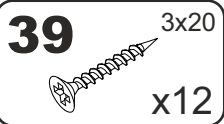
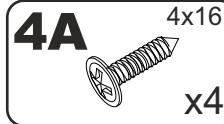

13

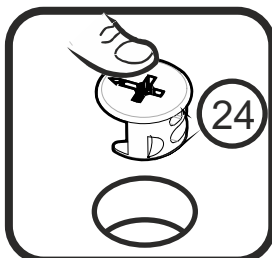
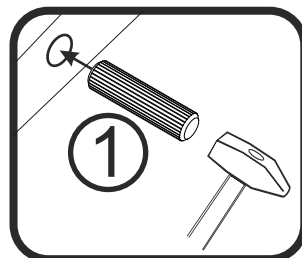
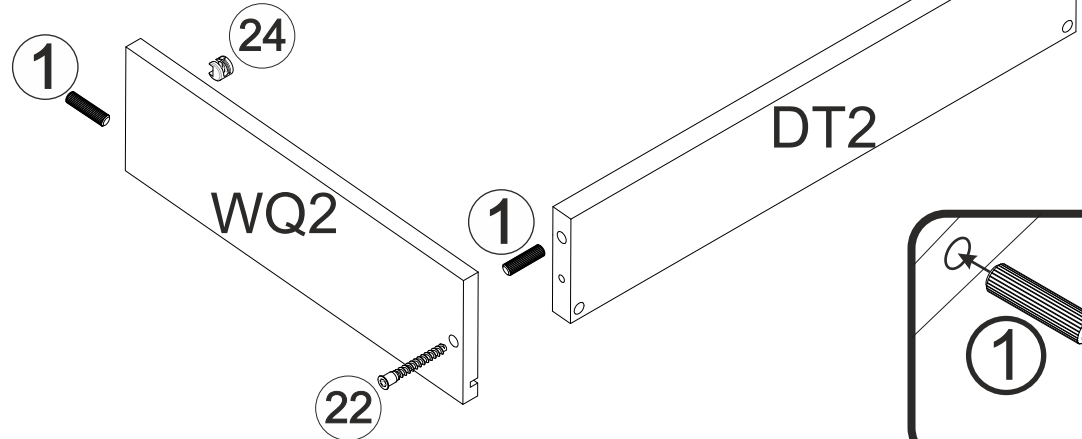
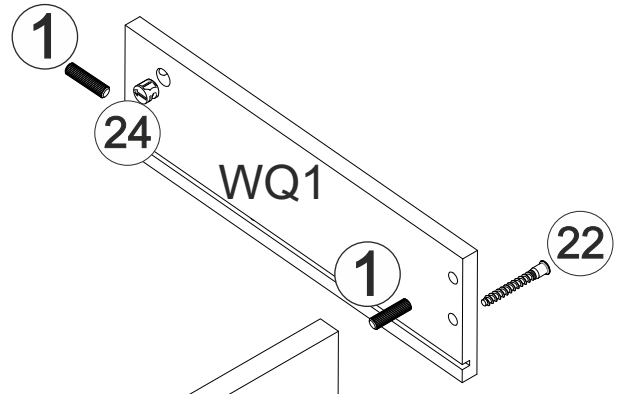
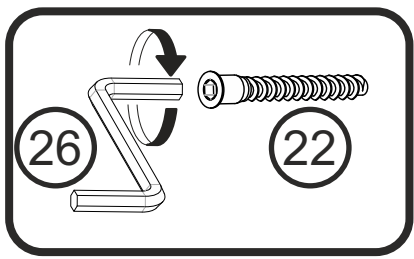
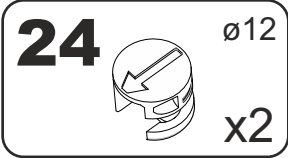
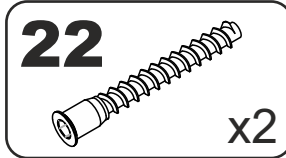
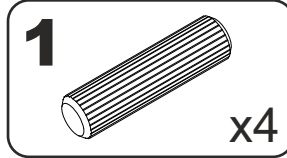

14

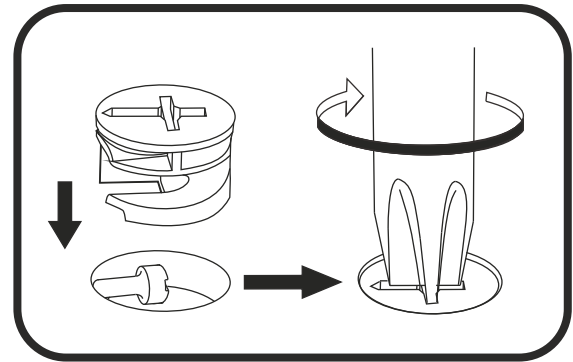
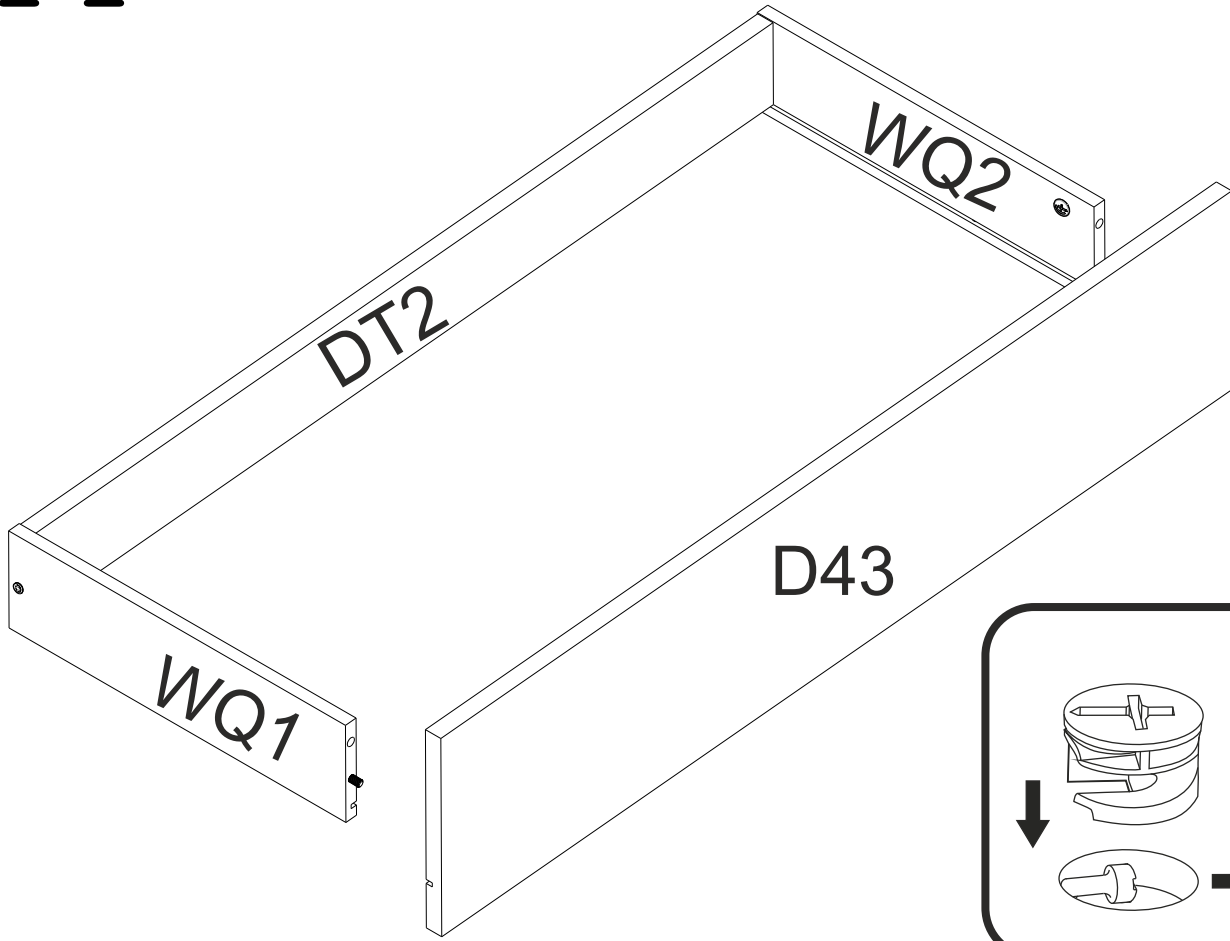

15

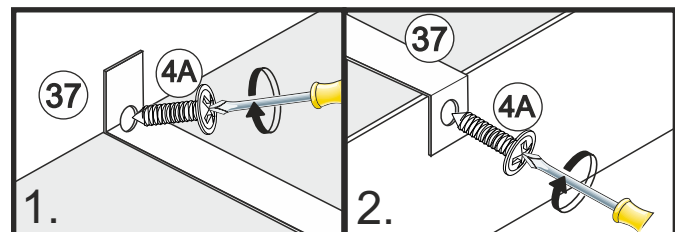
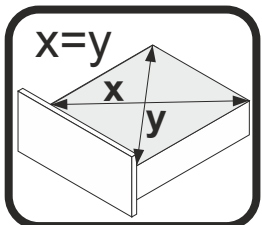
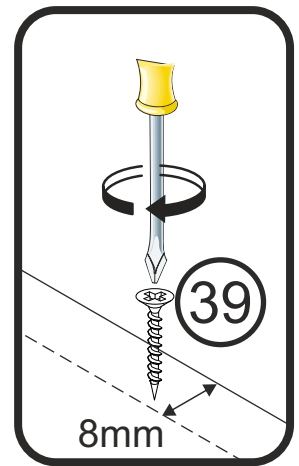
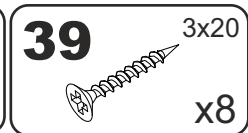
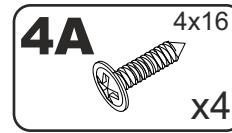
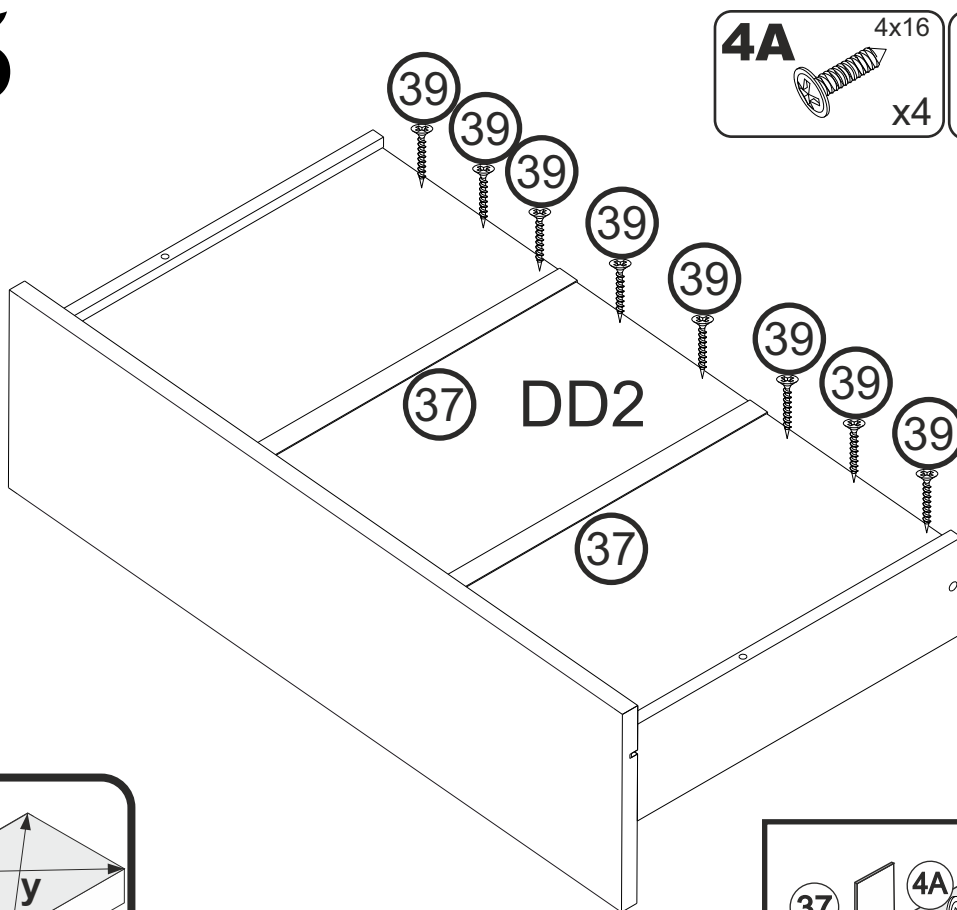

16

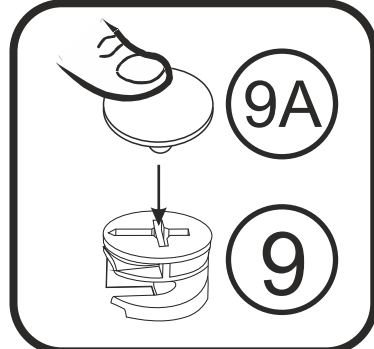
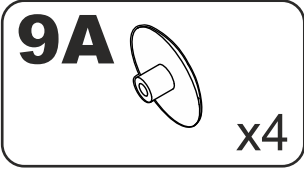
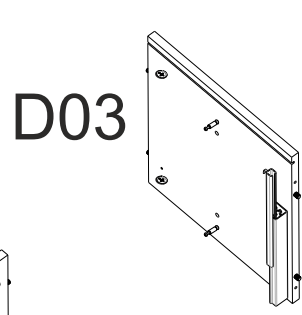
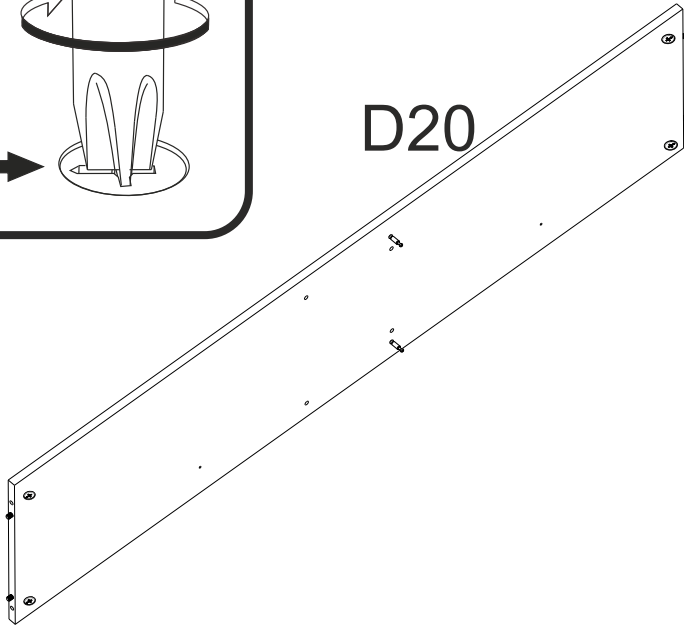
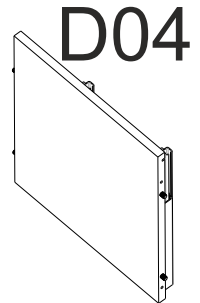
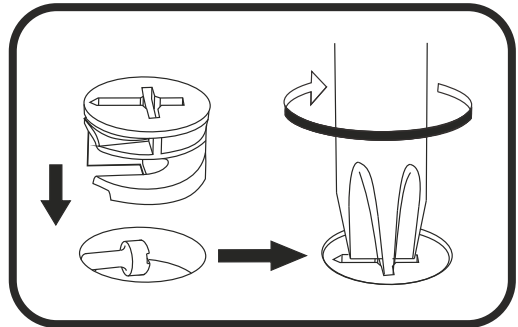

17

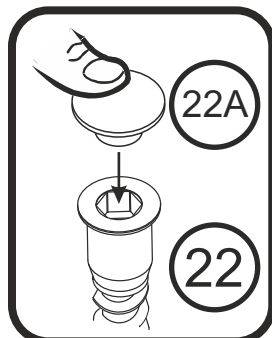
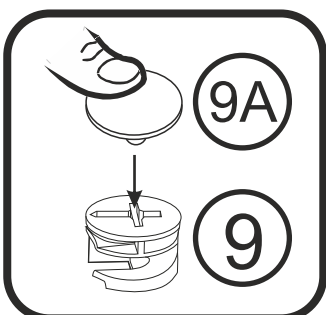
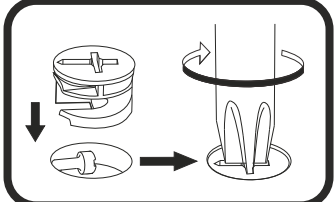
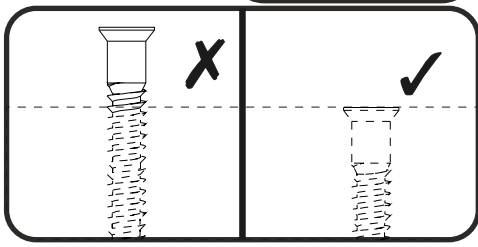
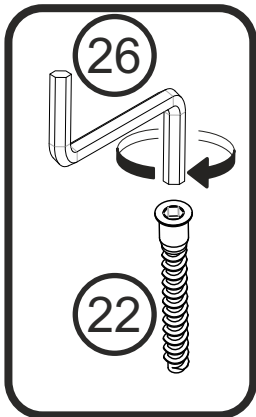
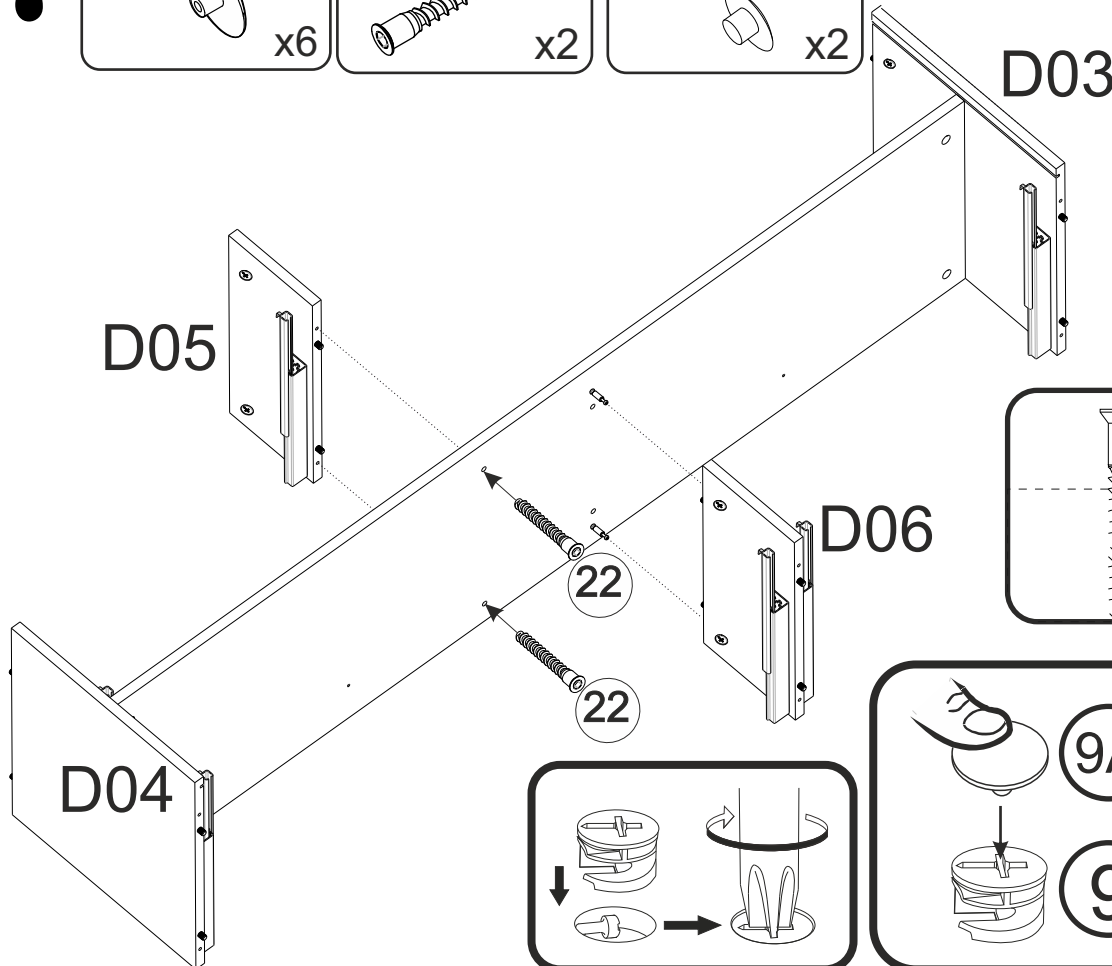
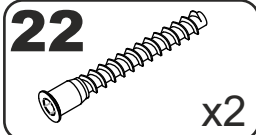

18

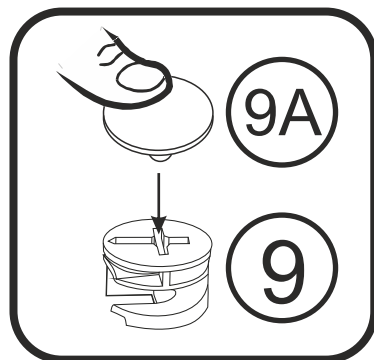
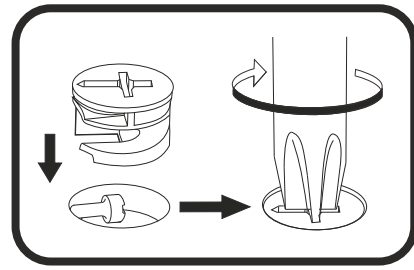
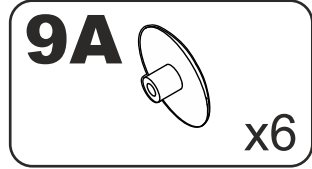
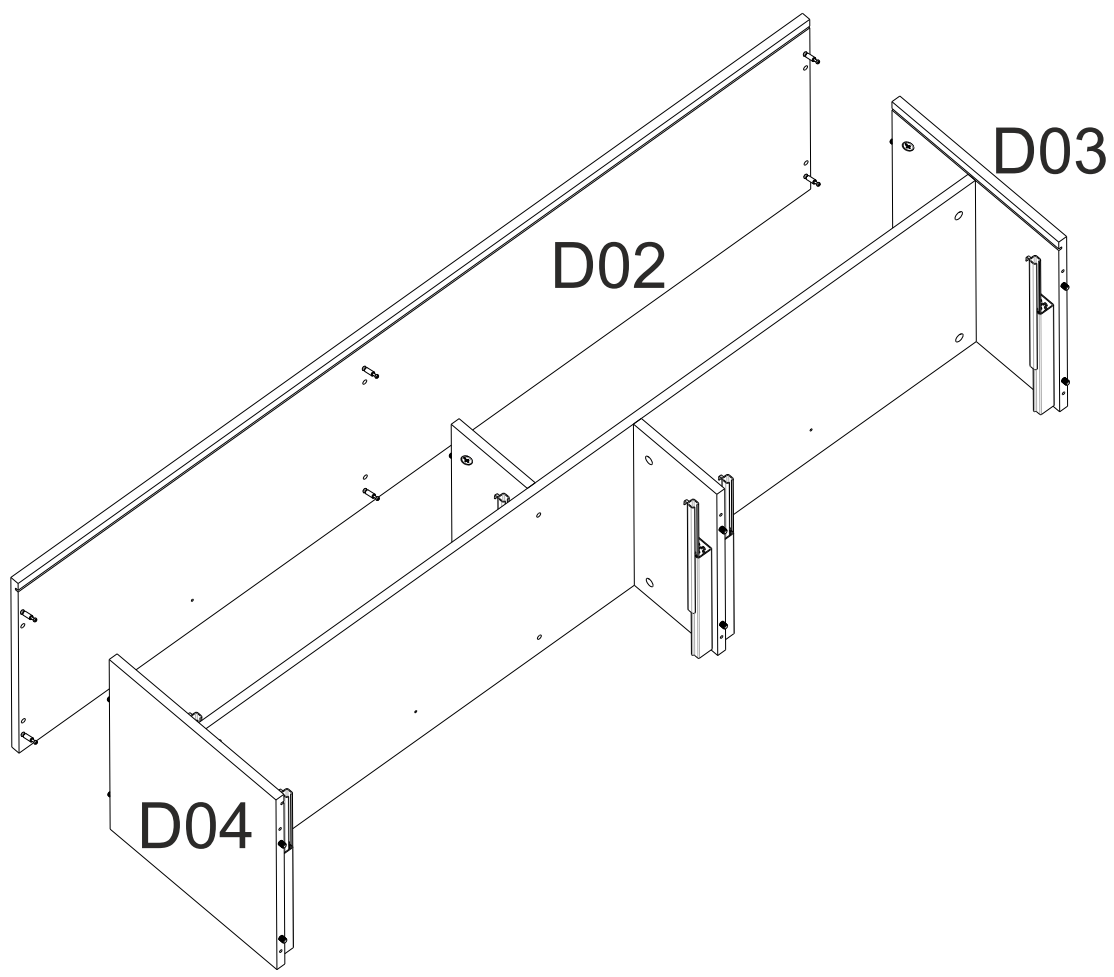

19

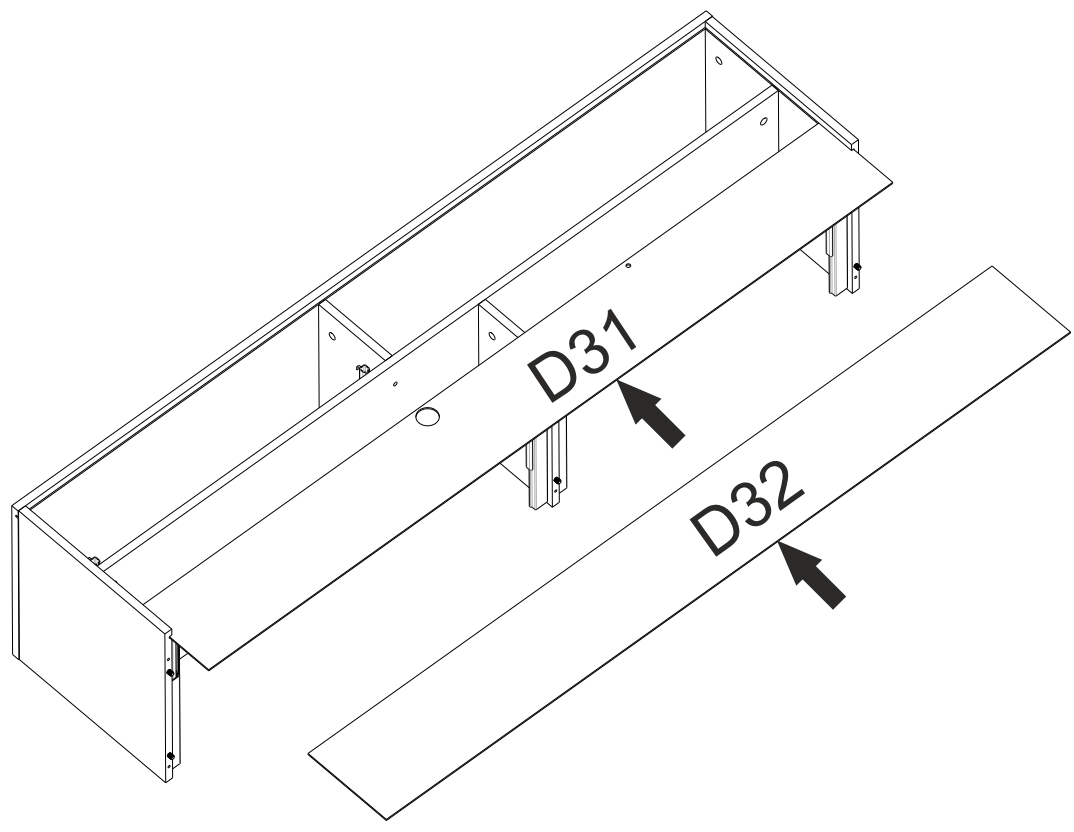

20

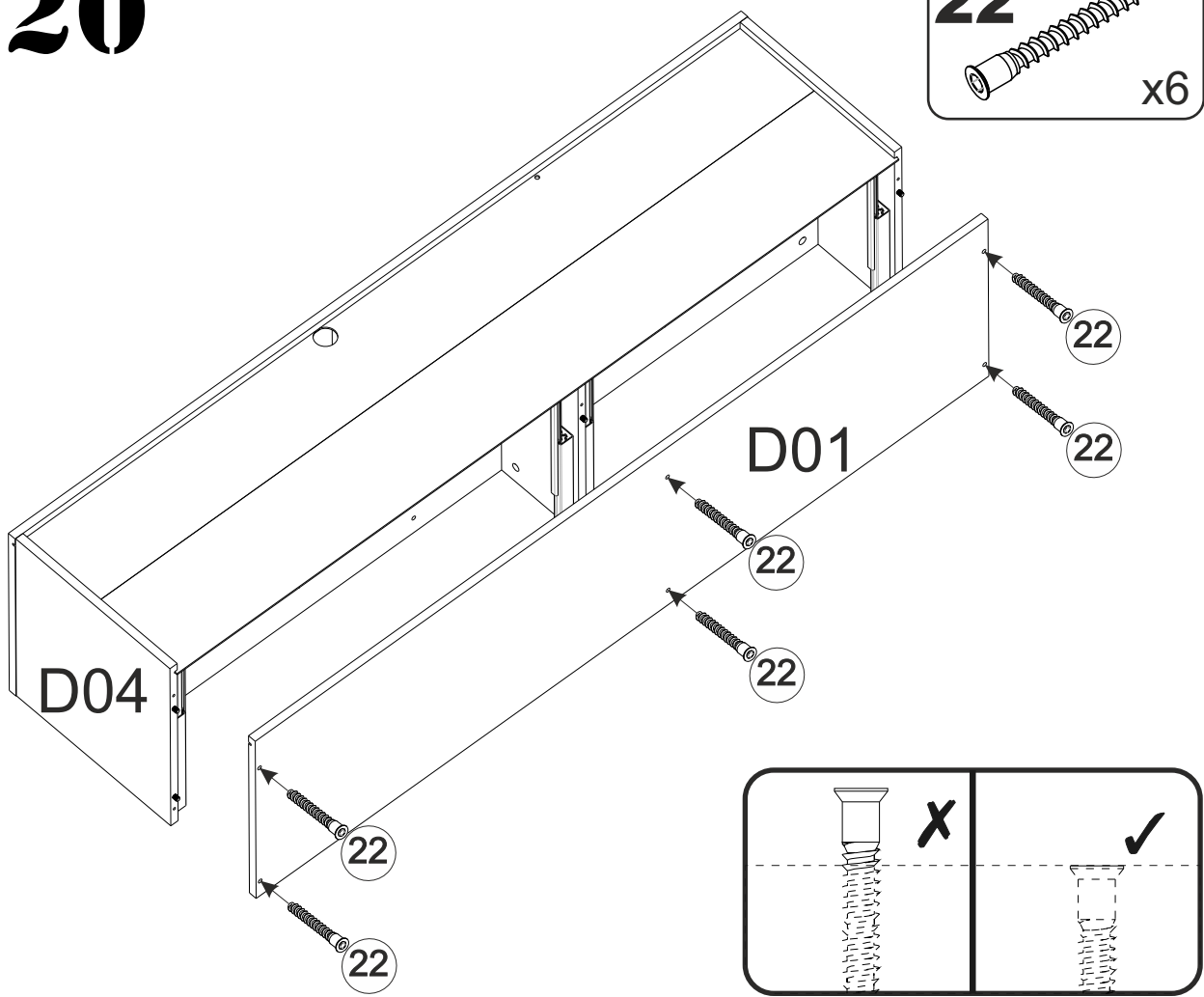

22 x6

22A x6

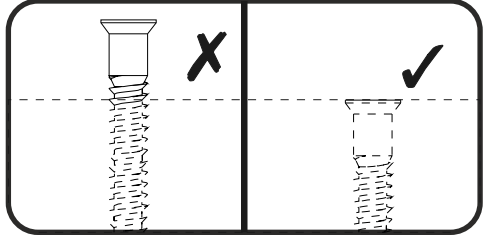
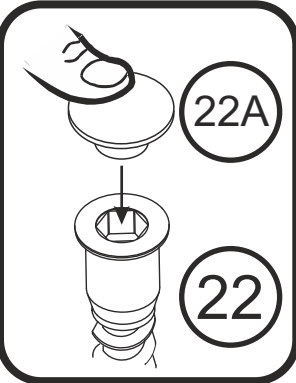
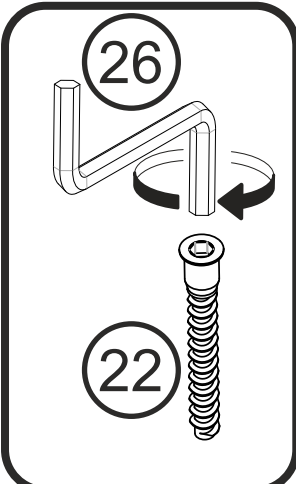

21

4A 4x16 x5

10 x5

35 x8

38 x14

39 3x20 x22

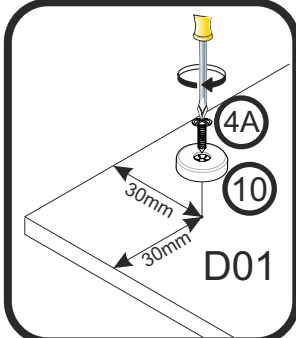
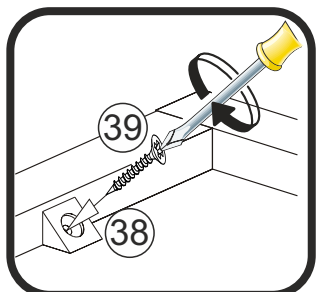
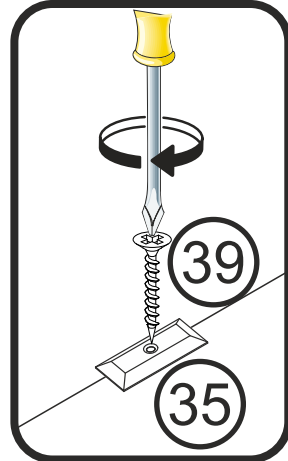
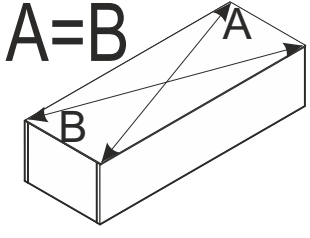
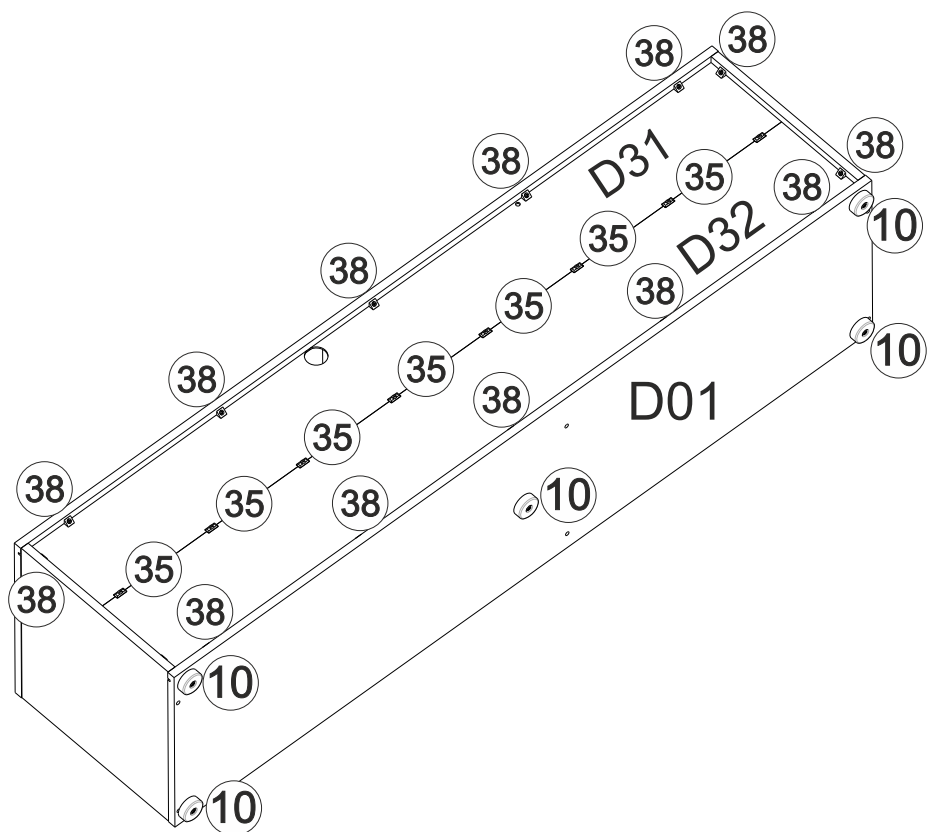

22

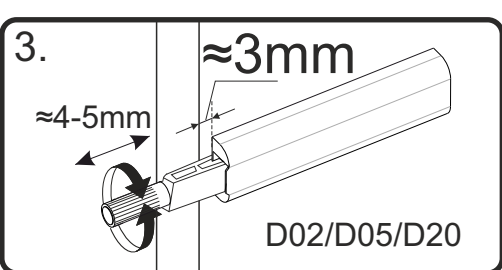
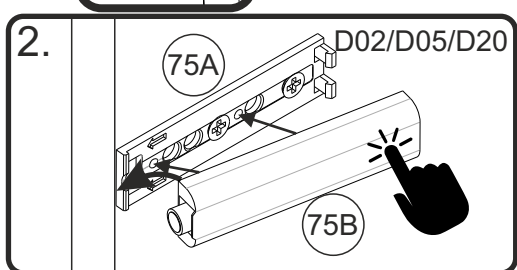
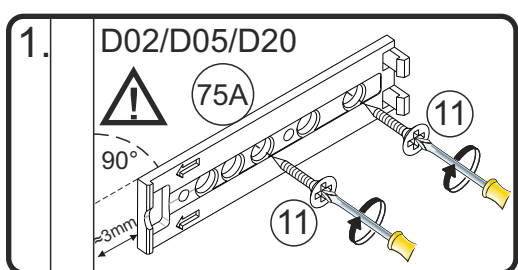
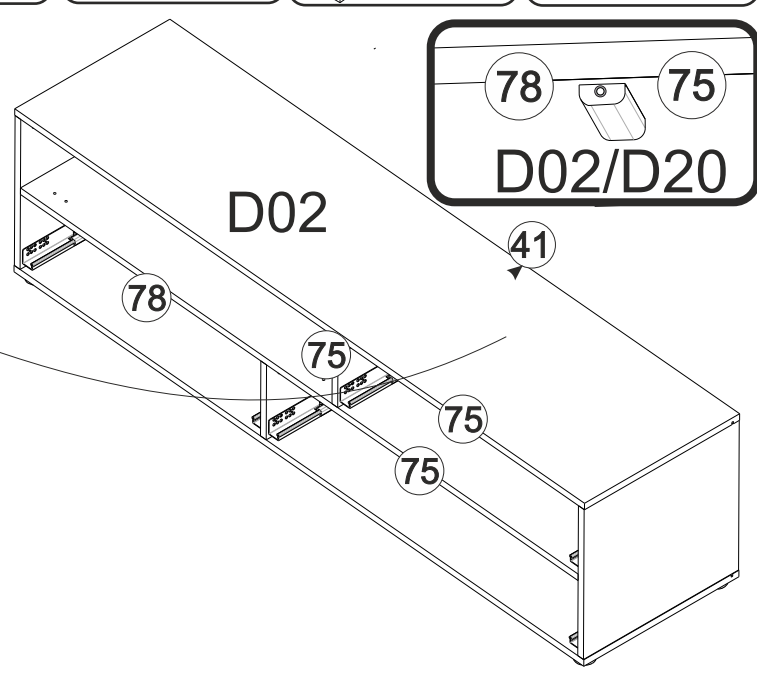
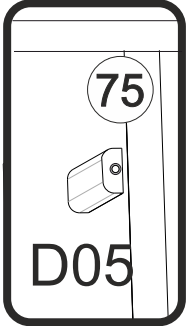
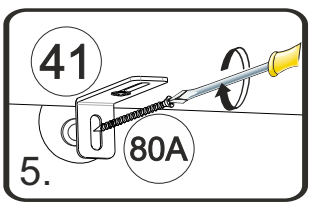
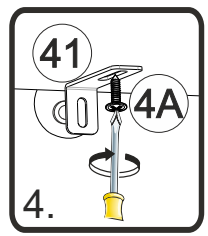
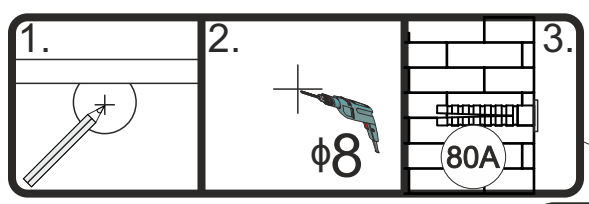
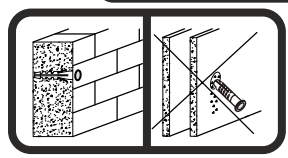
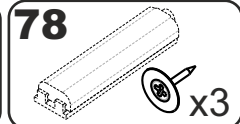
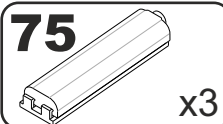
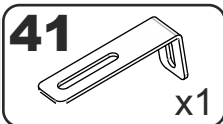
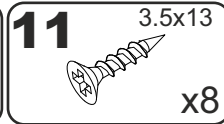
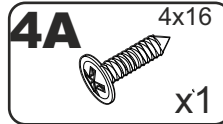

23

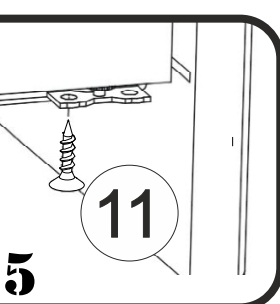
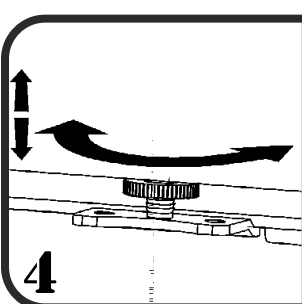
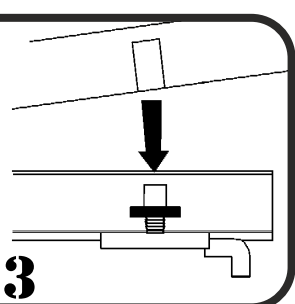
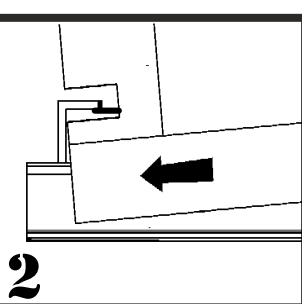
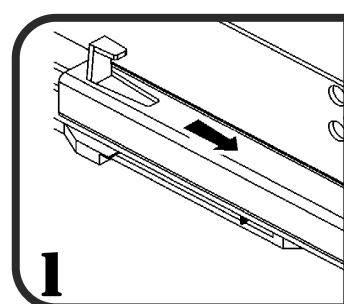
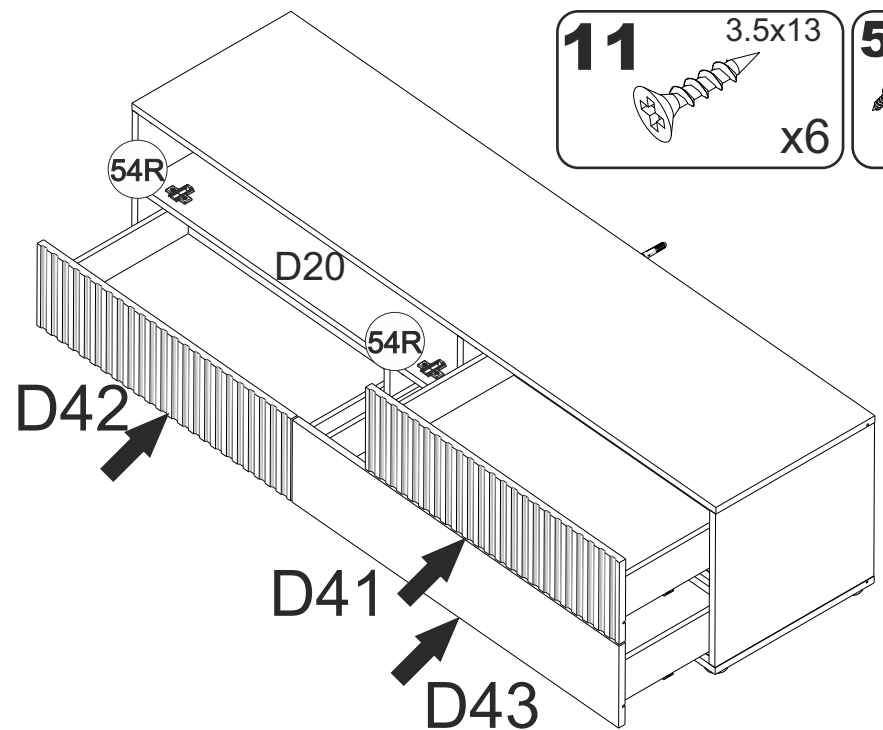
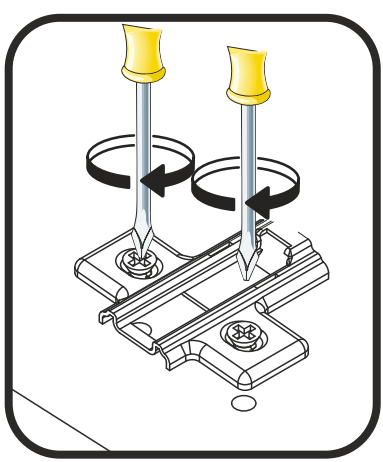
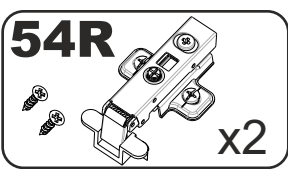
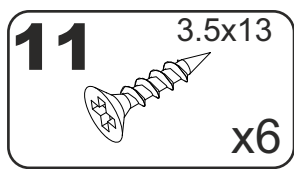

24

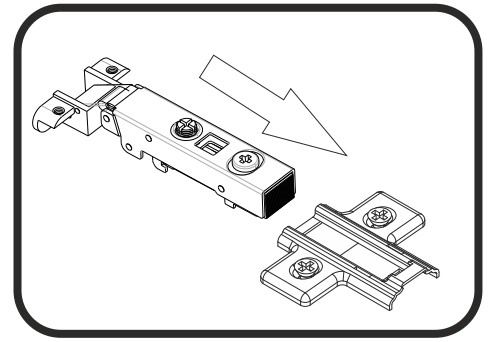
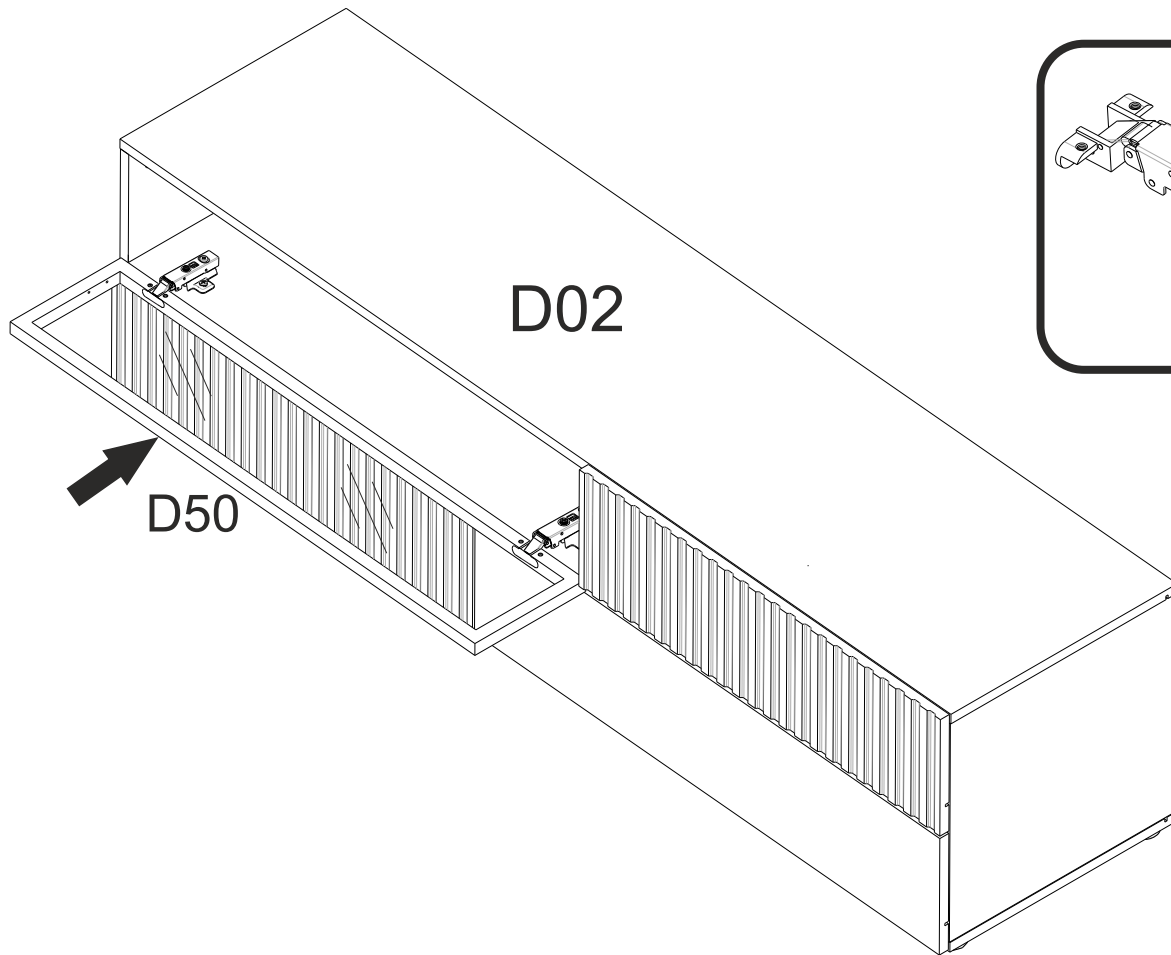

25

