

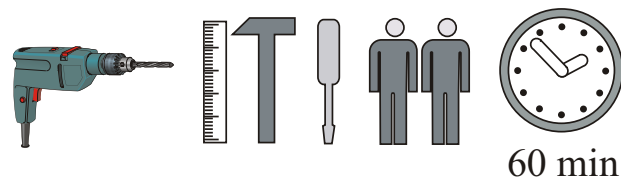

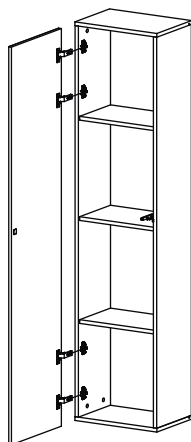

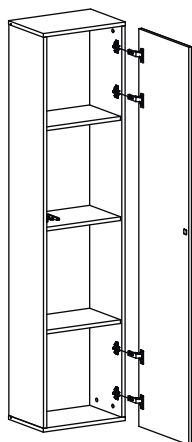

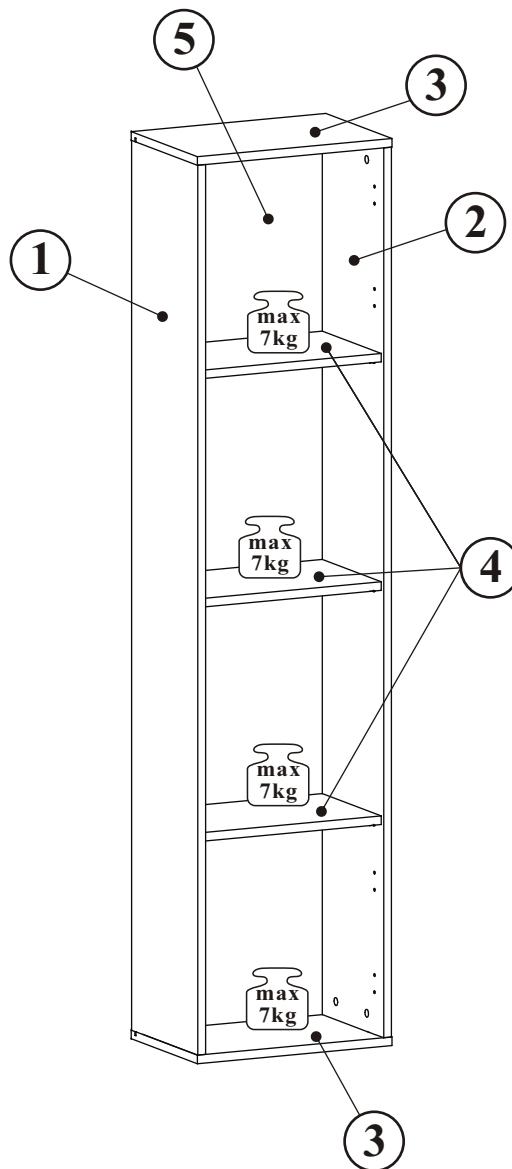

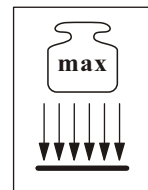
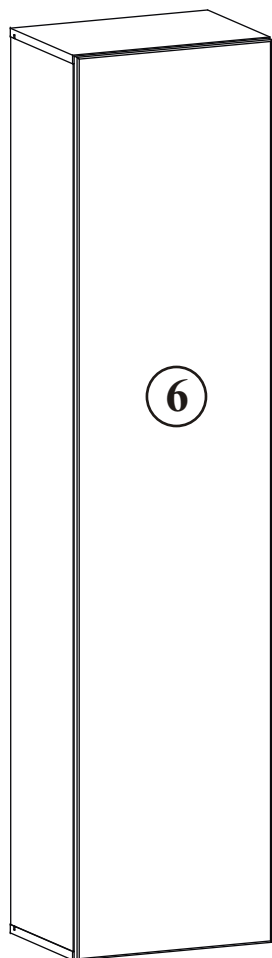

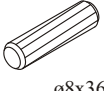
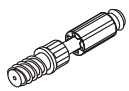
# FLY 28 -- FY 40-C

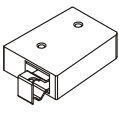

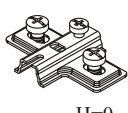
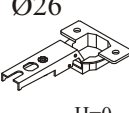
60 min

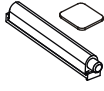
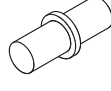
NO	Dim.		Col.-No	Qty
1	1668	274	1	1
2	1668	274	1	1
3	400	274	1	2
4	366	244	1	3
5	1680	378	1	1
6	394	1696	1	1

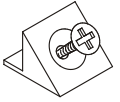
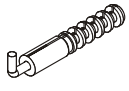
FLY 28--FY 40-C

A1 x8  ø8x36	B4 x8 	B5 x8  ø15x12	G5 x8 	ZR1 x2 	D6 x4  USØ3,5x30
E2 x4  H=0	E1 x4  Ø26 H=0	D10 x10  USØ3,5x13	AM x1 	G7 x12 	Z2 x8  Ø5
S1 x12 	KR2 x2 	G2 x1 			

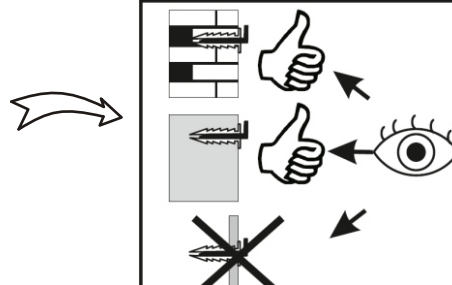
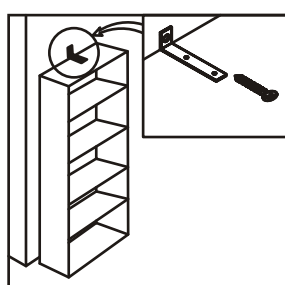
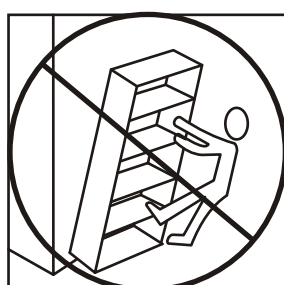
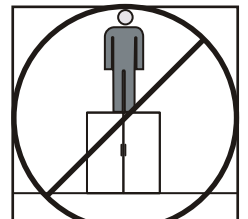
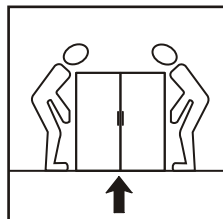
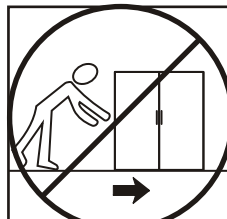
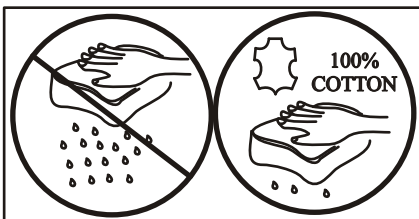
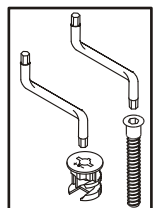
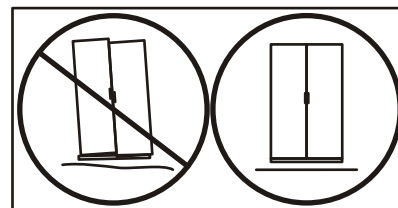
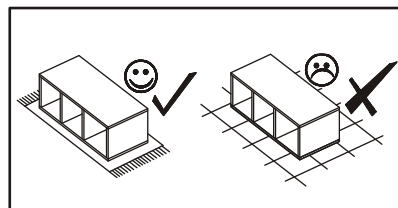
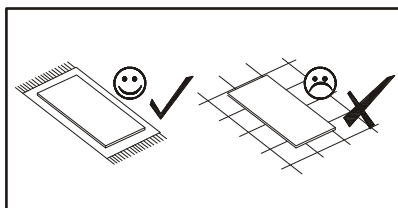
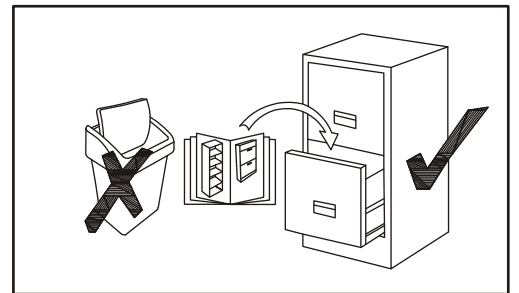
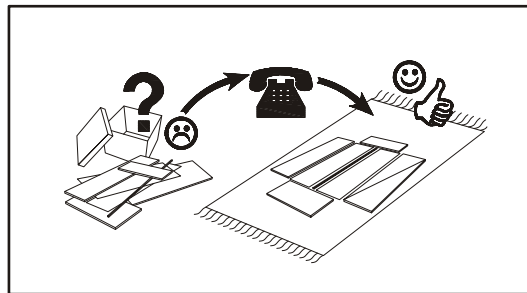
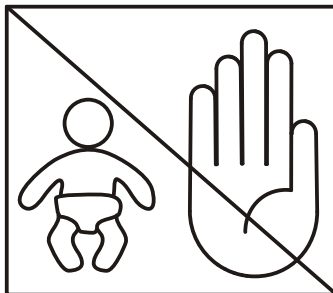
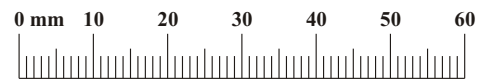

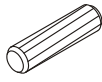
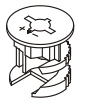
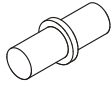
A1		B5		G7	
x8	ø8x36	x8	ø15x12	x12	

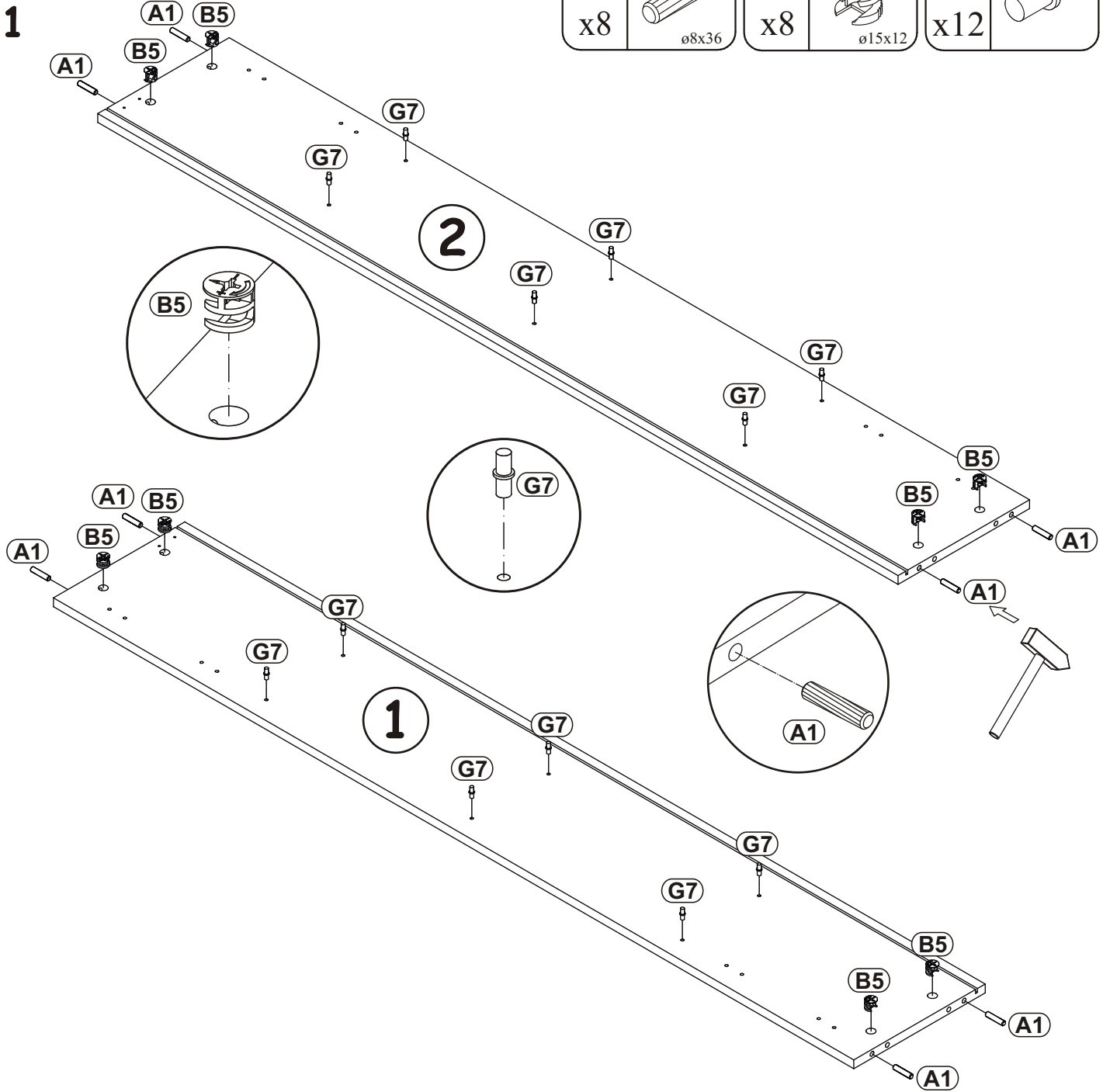

**2**

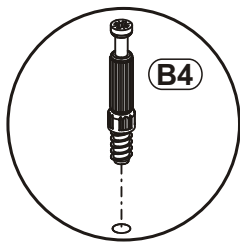

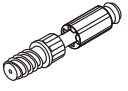
B4	
x8	

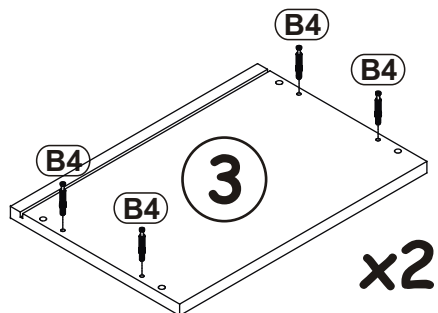

FLY 28--FY 40-C

3

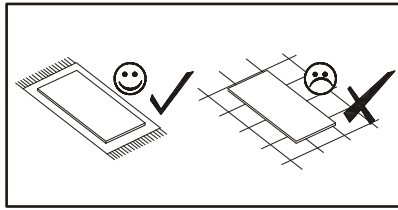

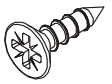

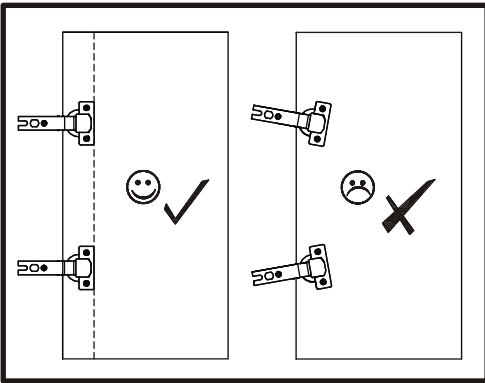
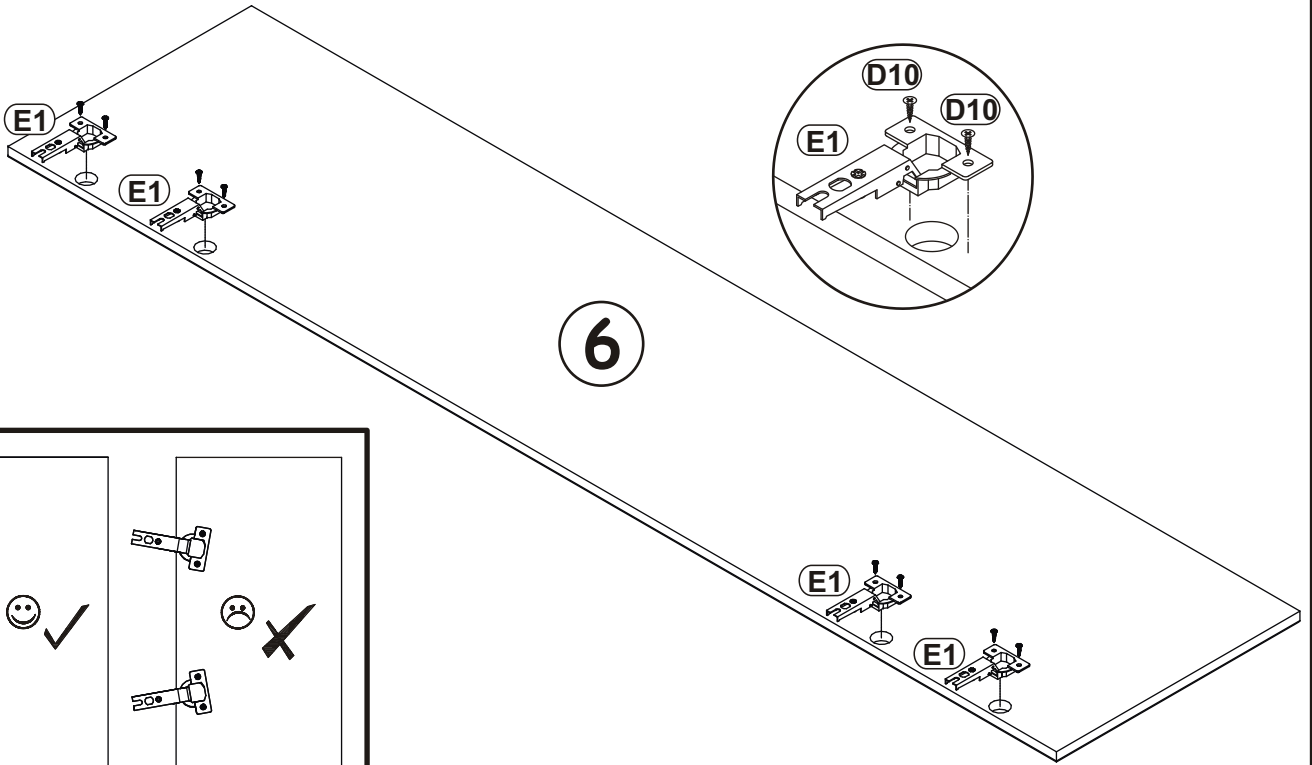
E1	Ø26	D10	 USØ3,5x13
x4	H=0	x8	

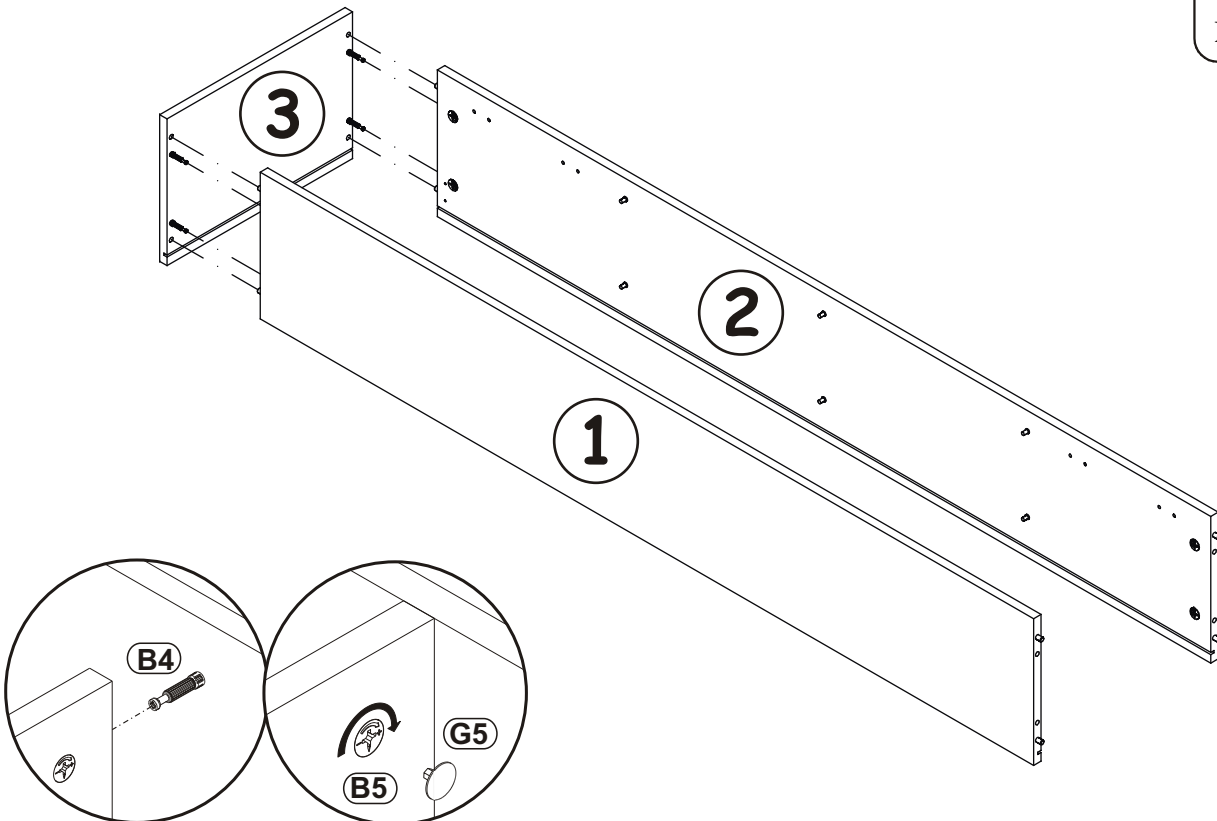

4

G5	
x4	



G5	
x4	

5

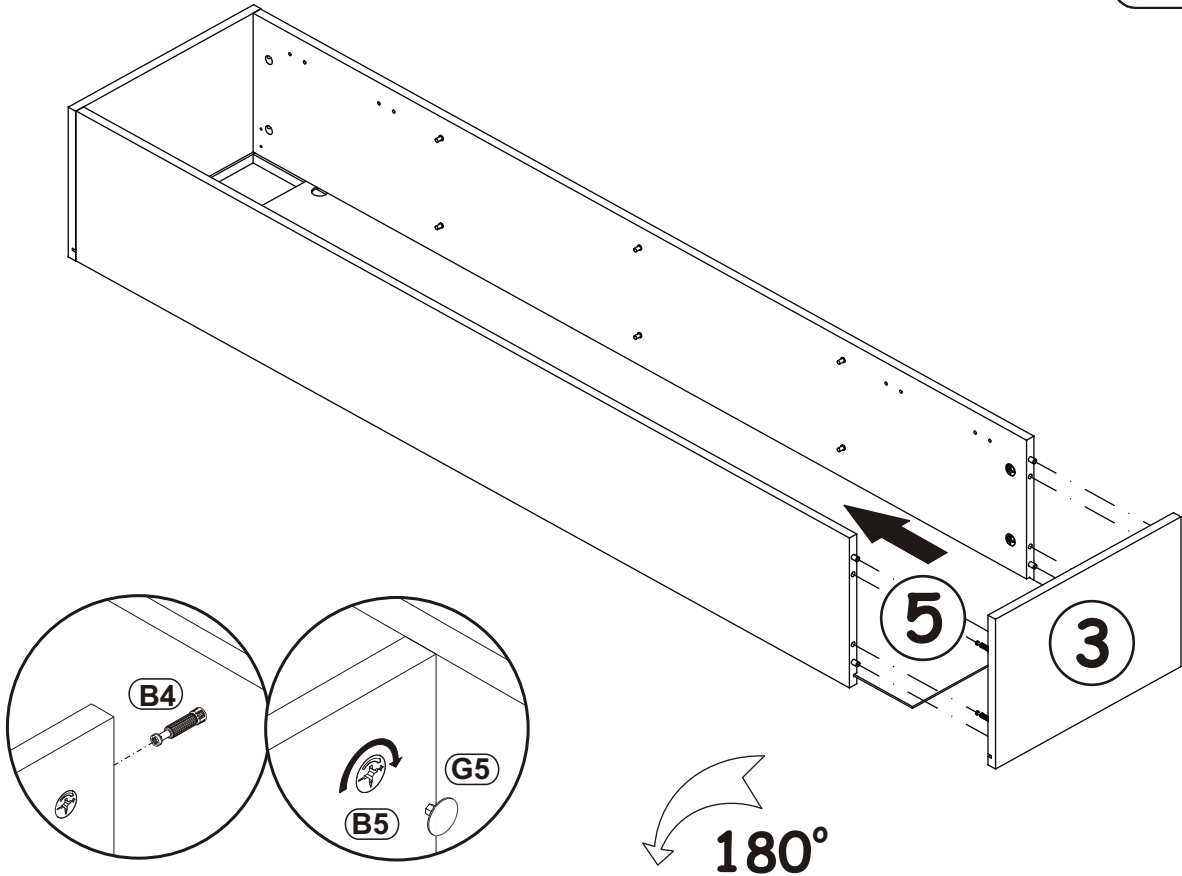

6

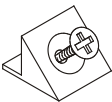

S1	
x12	

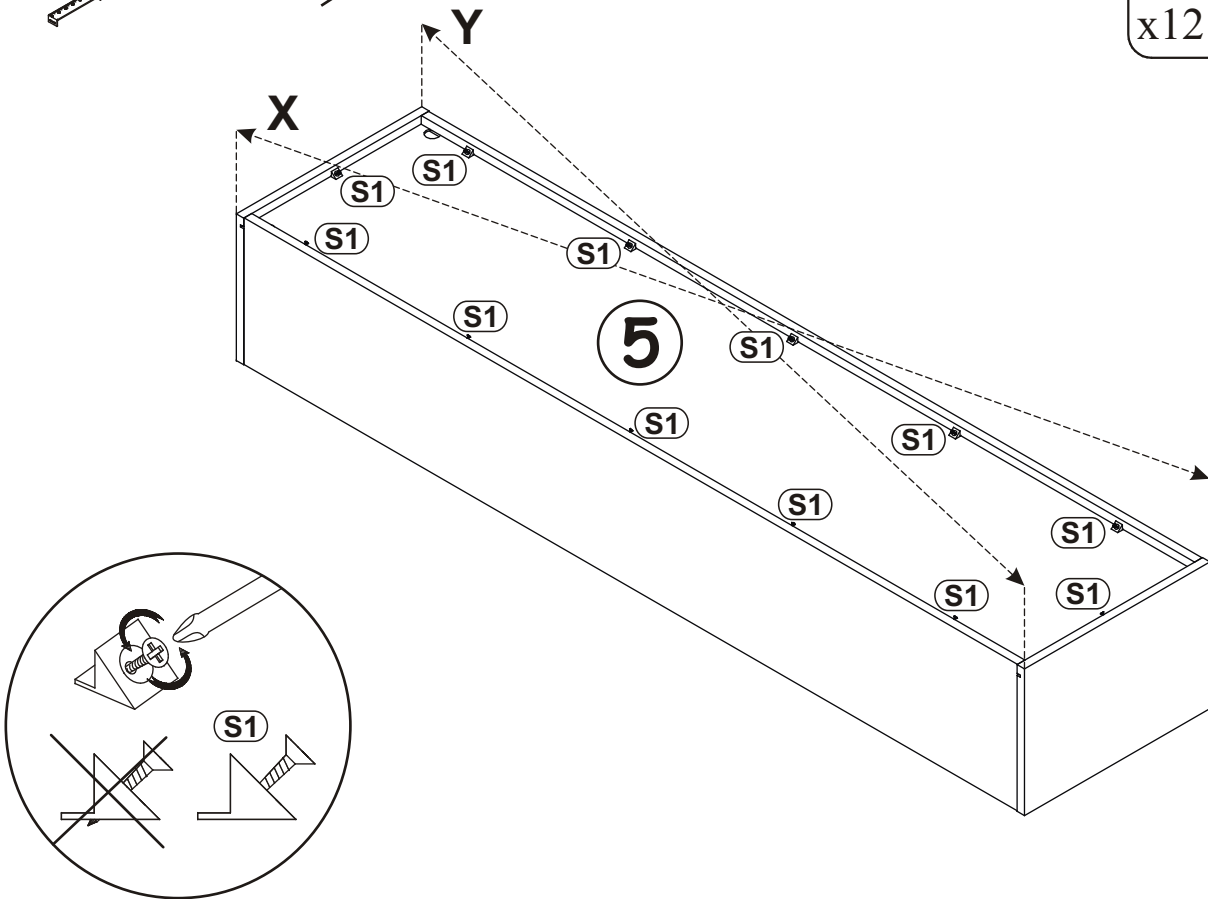

FLY 28--FY 40-C

7

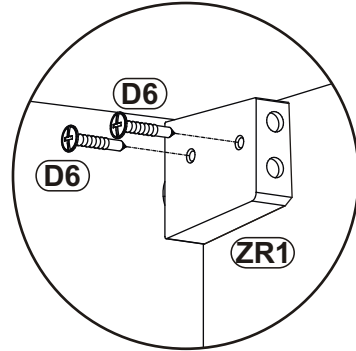
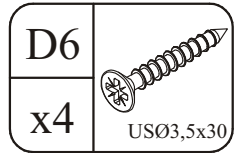
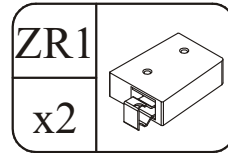
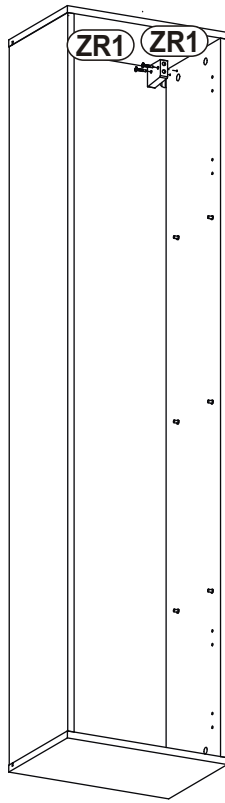
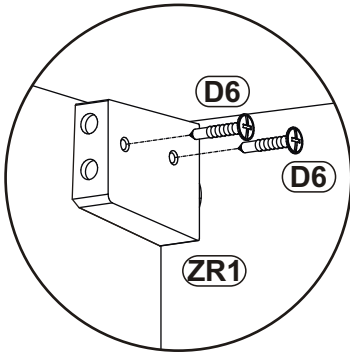

8

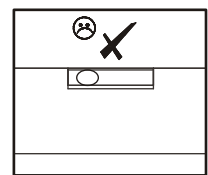
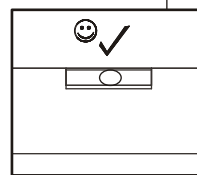
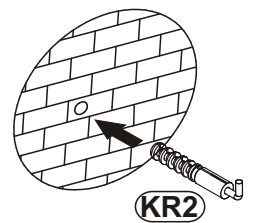
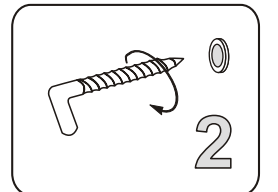
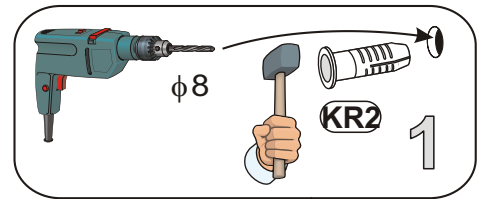
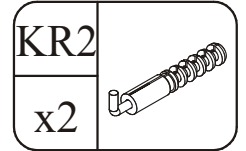
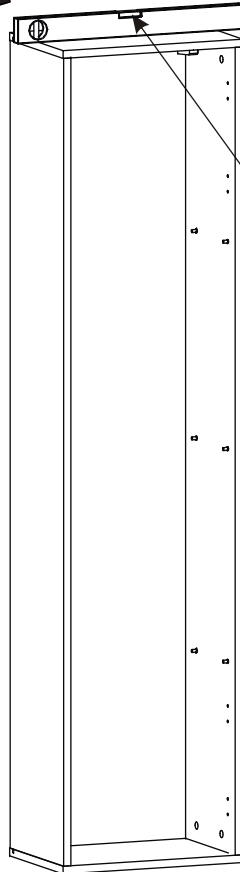
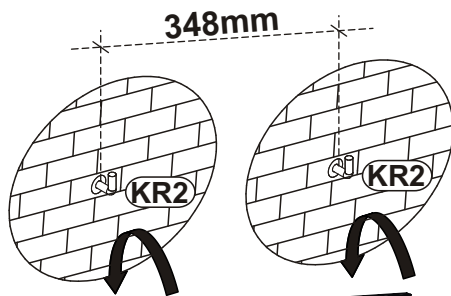
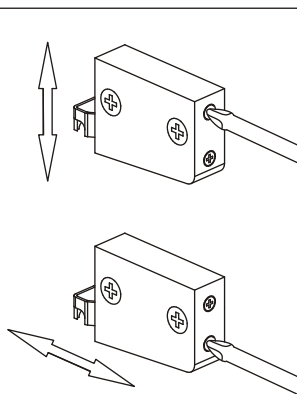
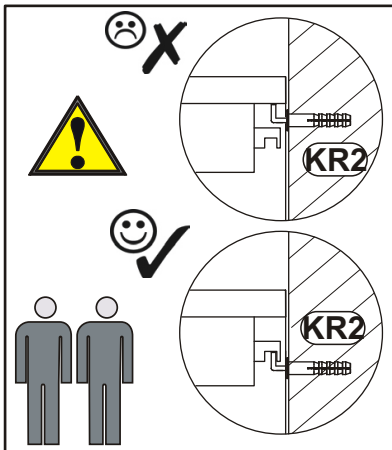
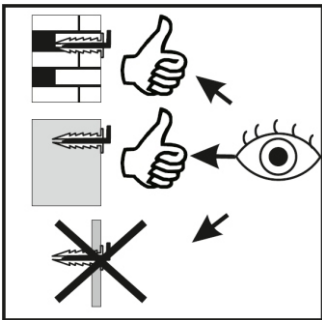

**9-10**

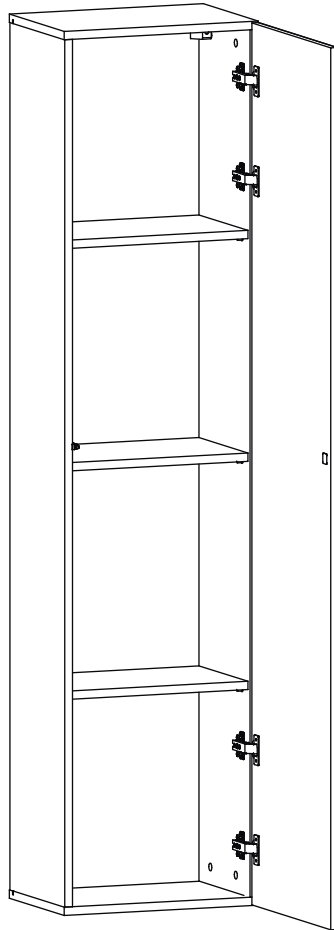

**11-12**

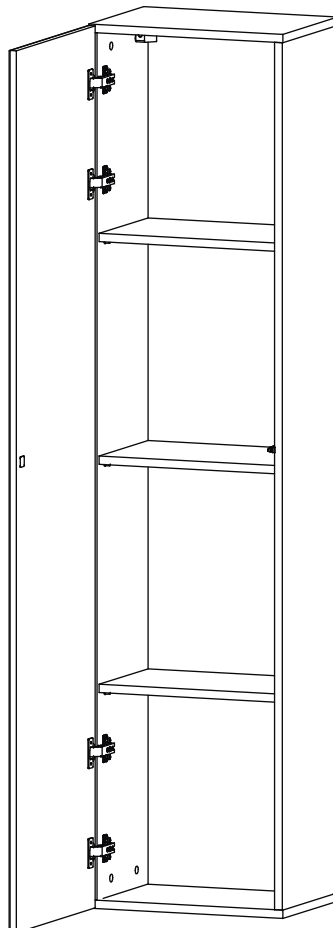

9

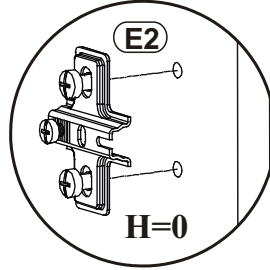
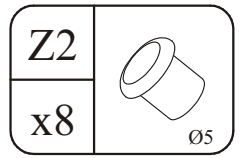
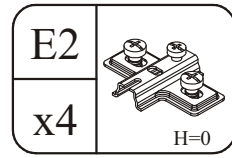
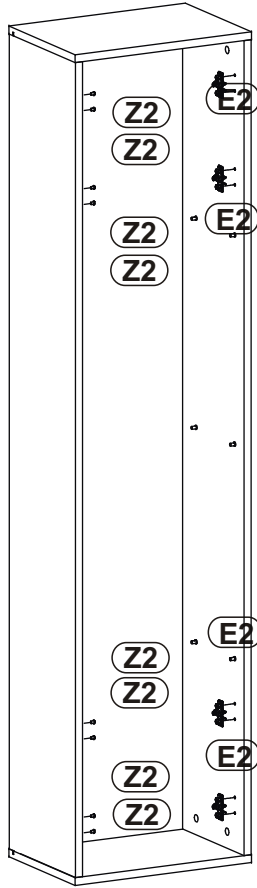
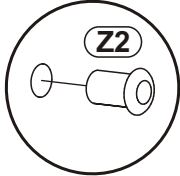
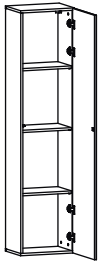

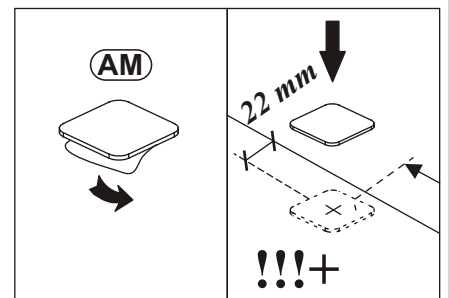
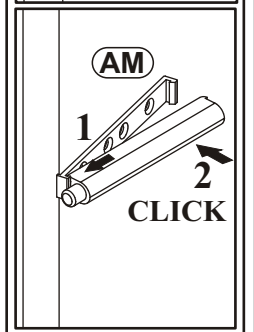
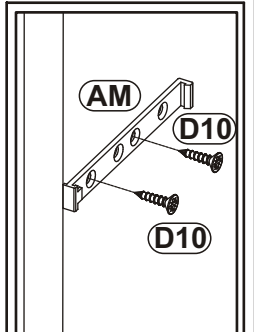
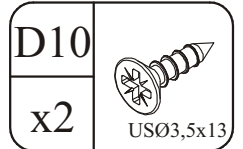
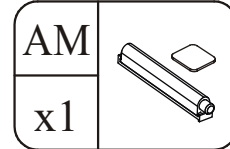
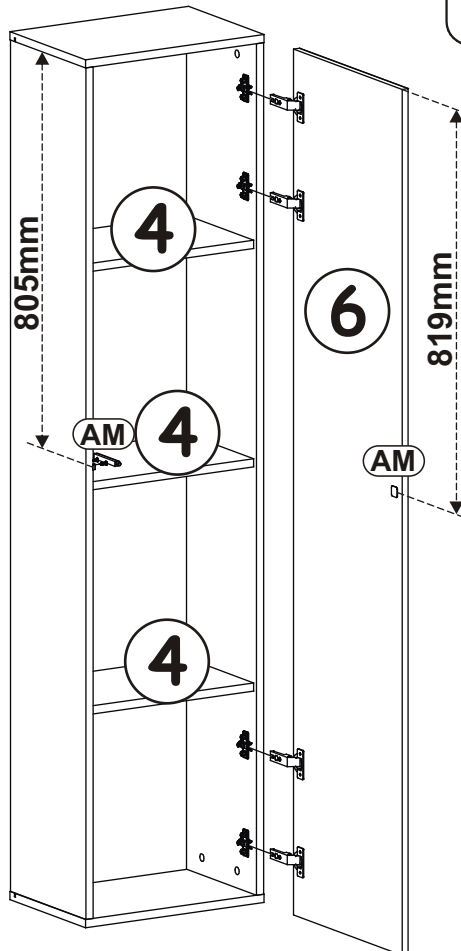
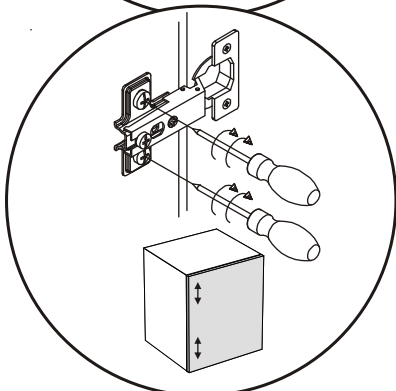
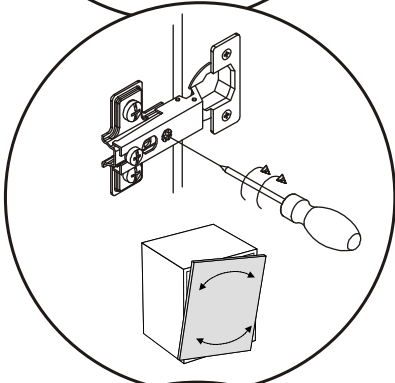
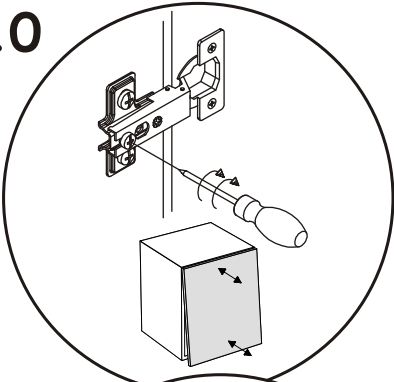

10

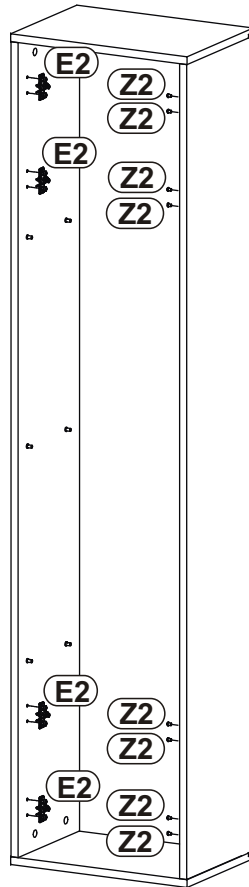
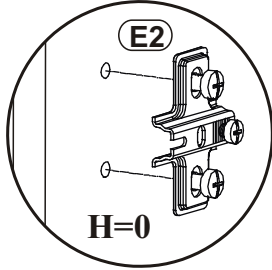
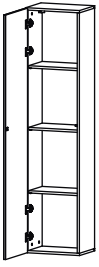

11

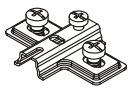

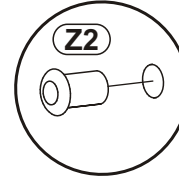

E2		Z2	
x4	H=0	x8	Ø5

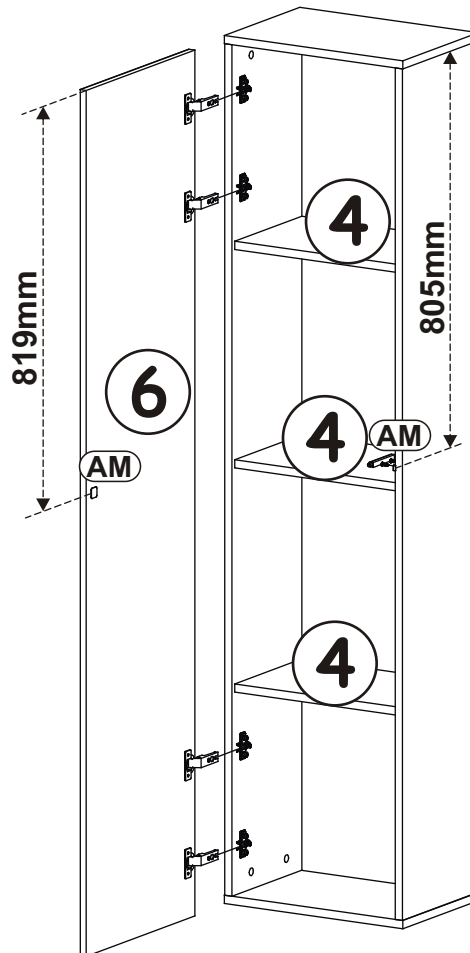
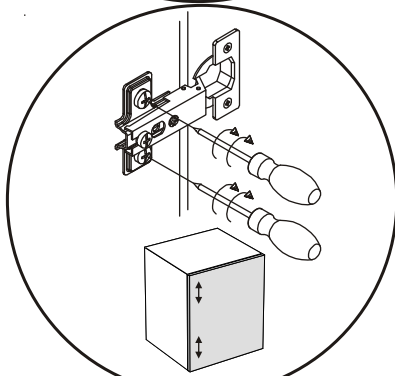
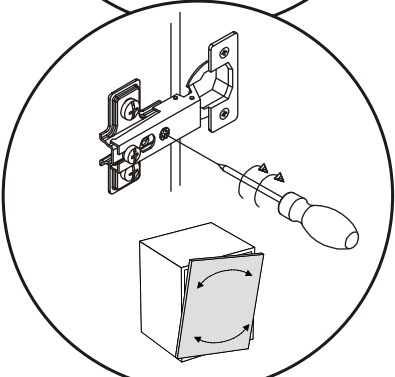
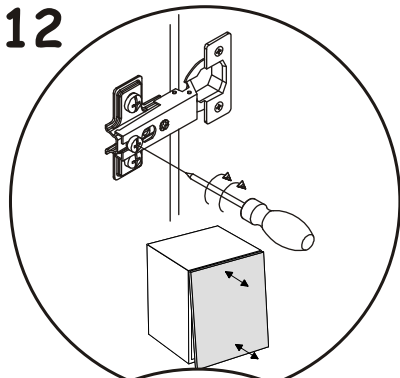

12

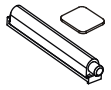

AM		D10	
x1		x2	USØ3,5x13

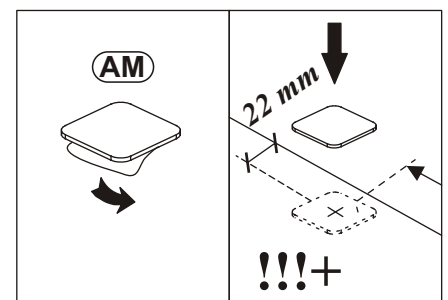
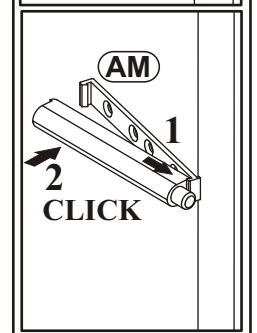
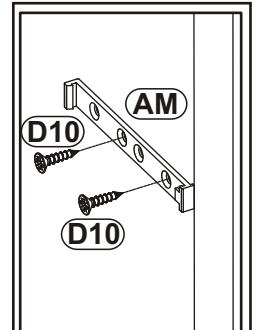



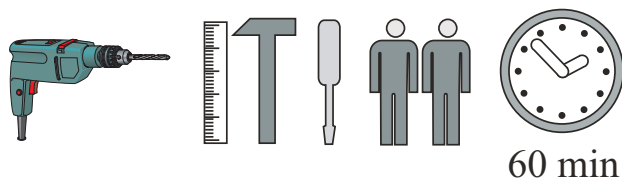
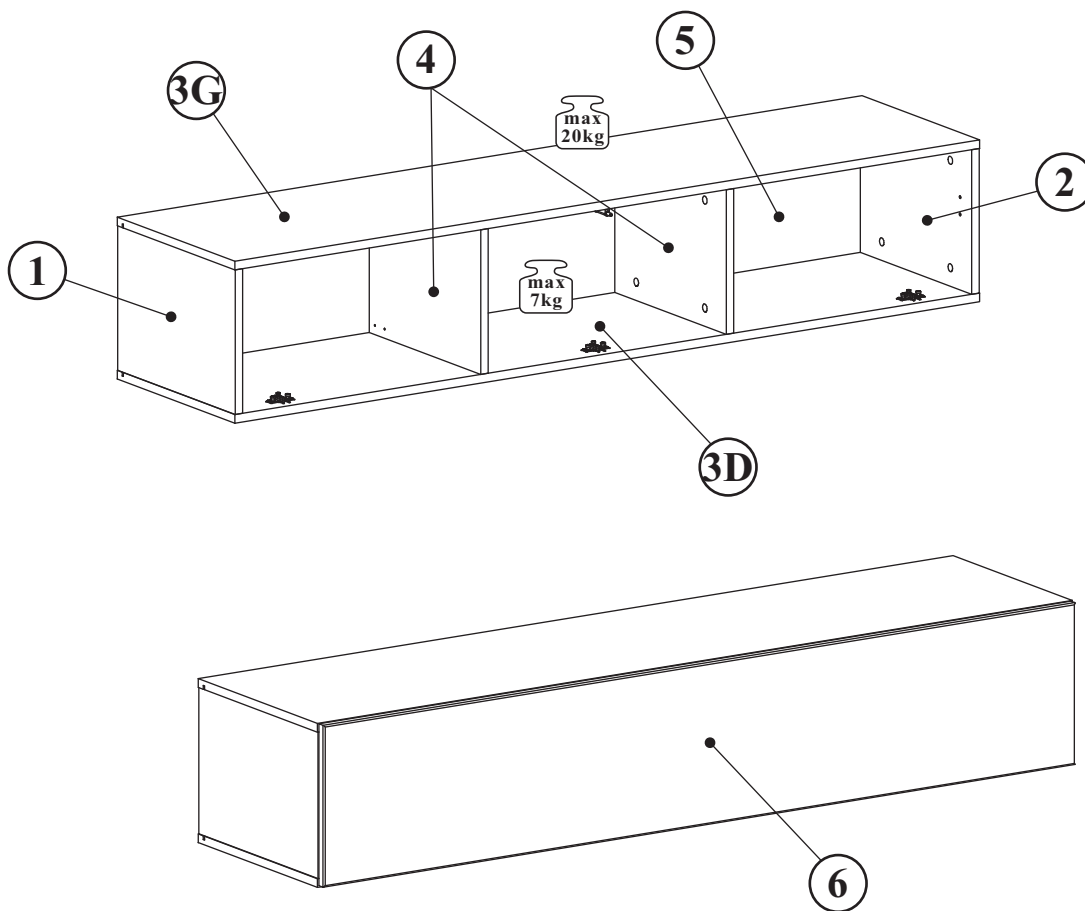
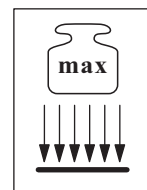





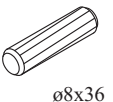
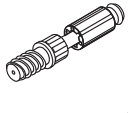

# FLY TYP-30

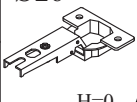
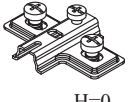
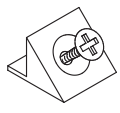

NO	Dim.			Col.-No	Qty
1	268	384	16	1	1
2	268	384	16	1	1
3D/G	1602	384	16	1	2
4	268	364	16	1	2
5	1580	280	3	1	1
6	1596	296	16	1	1

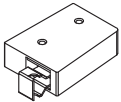
# FLY TYP-30

A1 x16  ø8x36	B4 x16 	B5 x16  ø15x12	G5 x16 	D7 x6  USØ3x16	G2 x1 
E1 x3 Ø26 H=0 	E2 x3 H=0 	S1 x12 	D6 x8 USØ3,5x30 	D10 x12 USØ3,5x13 	G21 x2 
ZR1 x4 	KR2 x4 	T1 x1 			

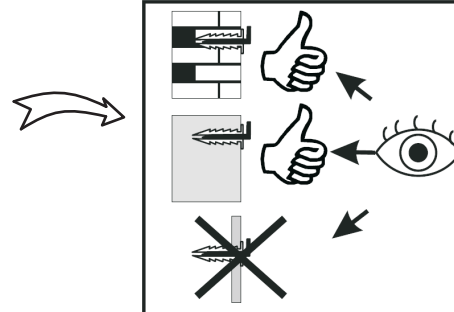
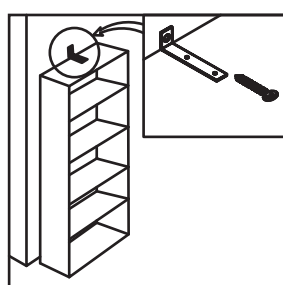
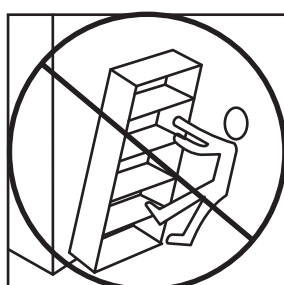
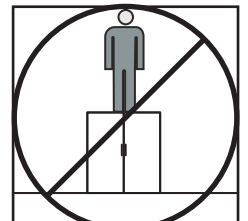
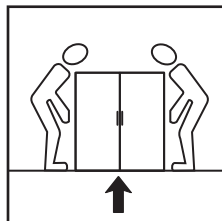
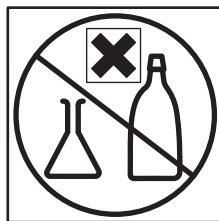
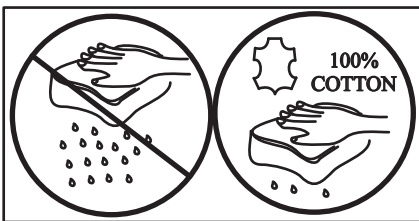
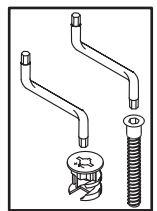
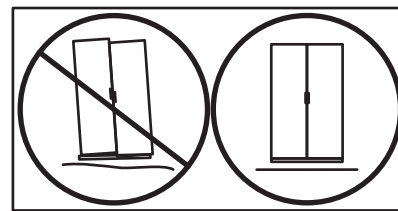
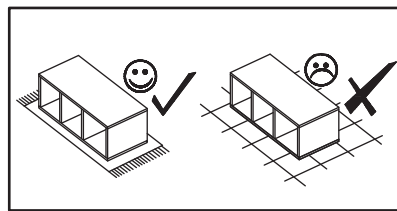
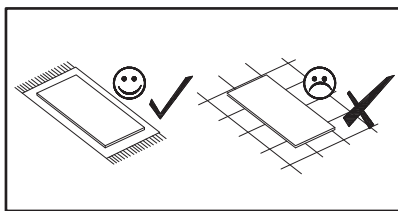
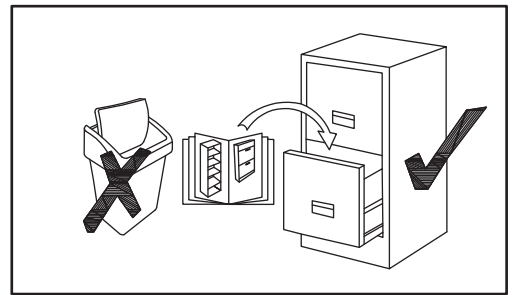
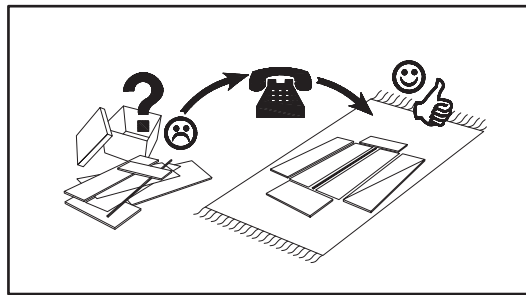
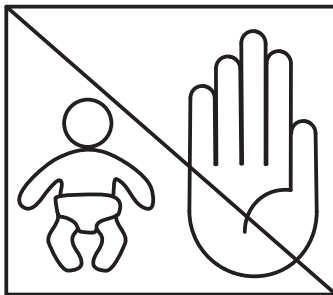
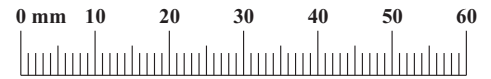

# FLY TYP-30

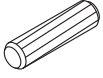
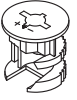
A1		B5	
x16	ø8x36	x16	ø15x12

## 1

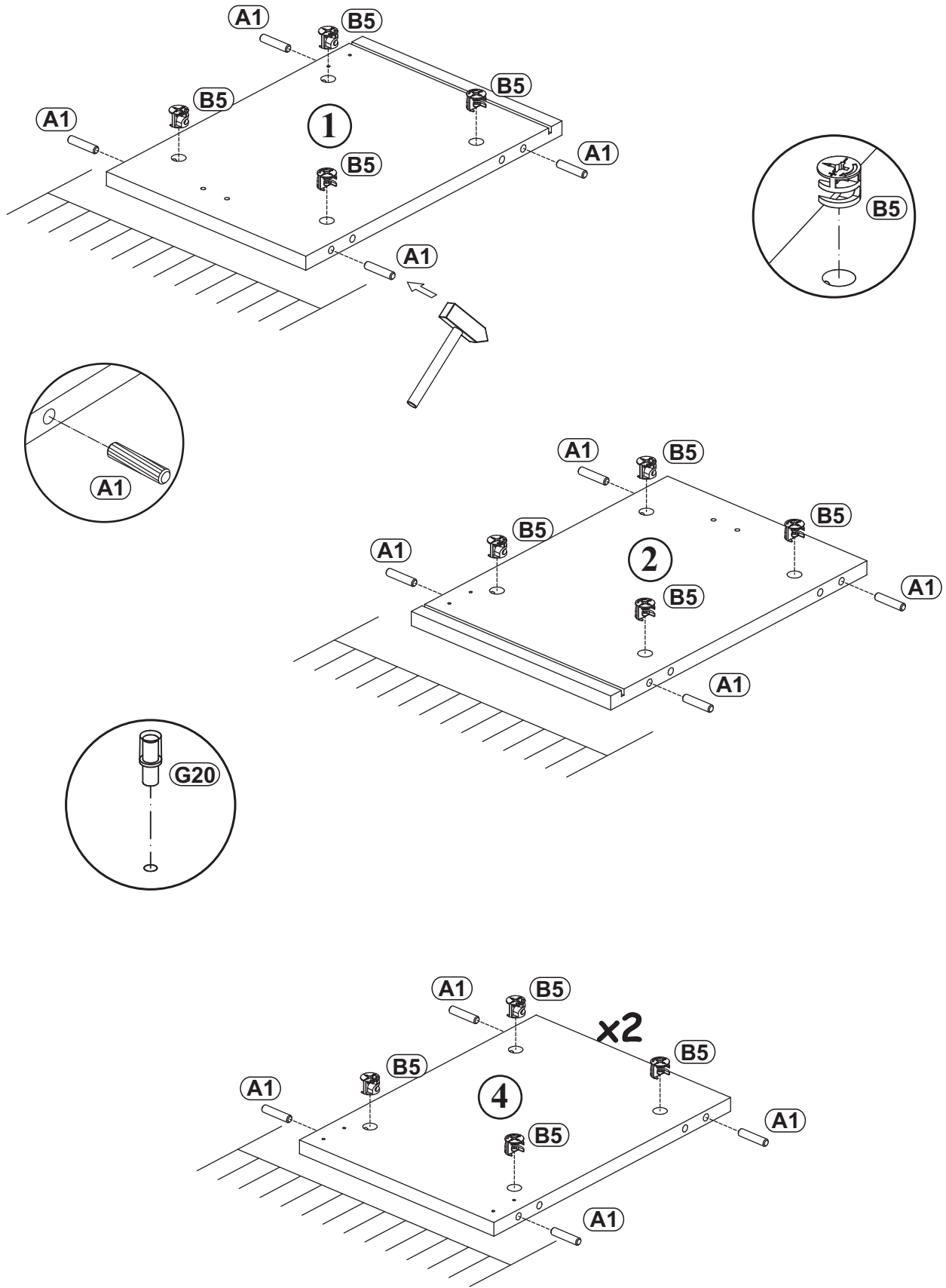

FLY TYP-30

2

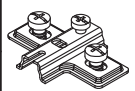
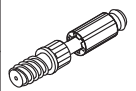
E2		B4	
x3	H=0	x16	

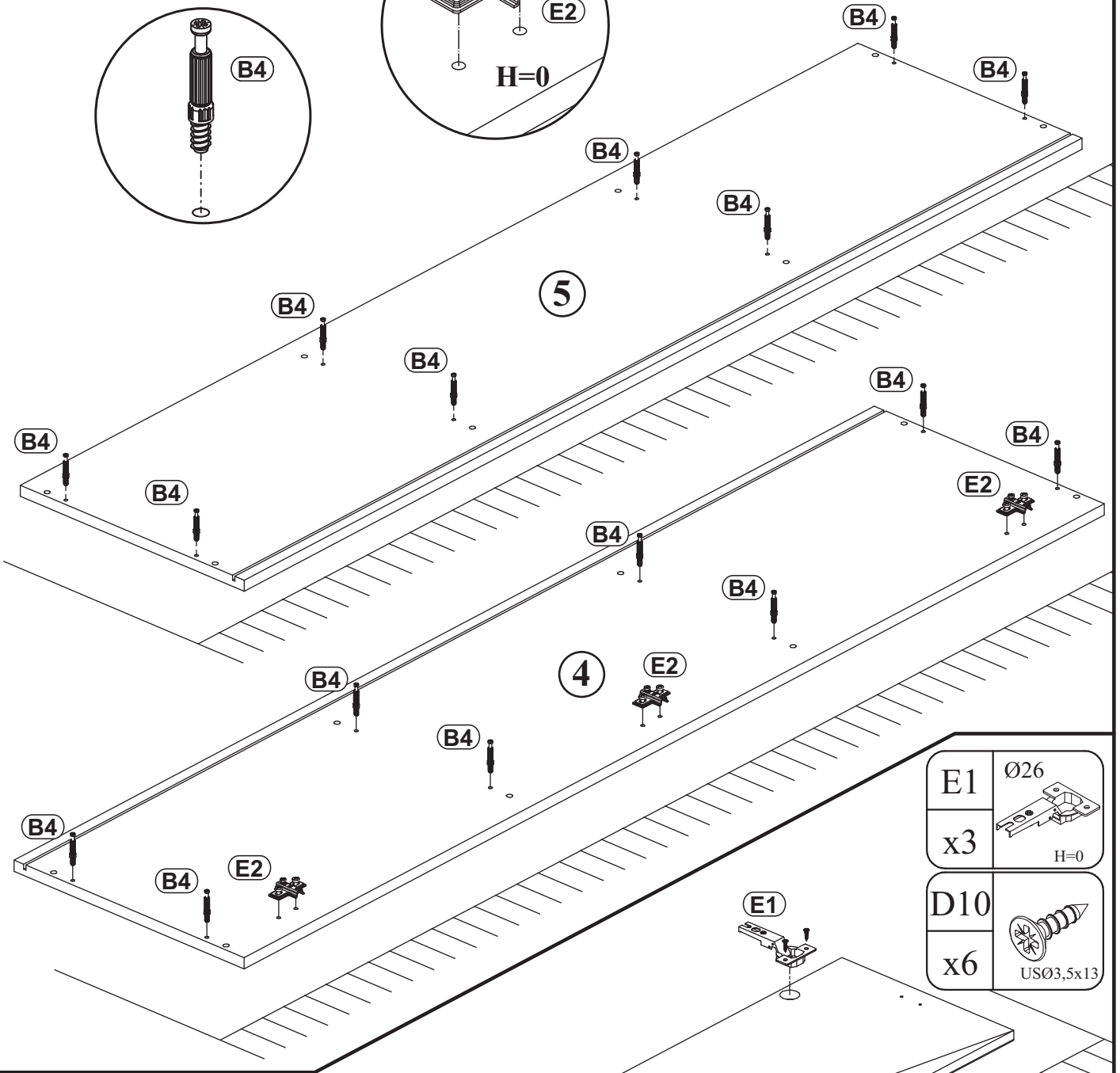
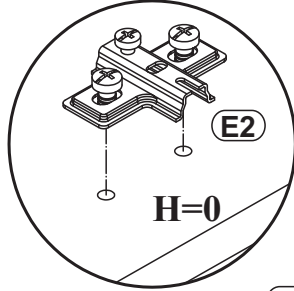
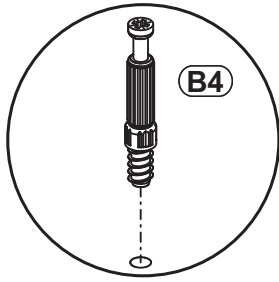

3

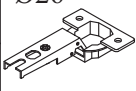
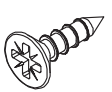
E1		Ø26
x3	H=0	
D10		
x6	USØ3,5x13	

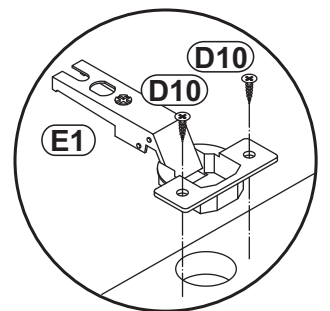
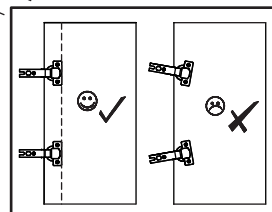
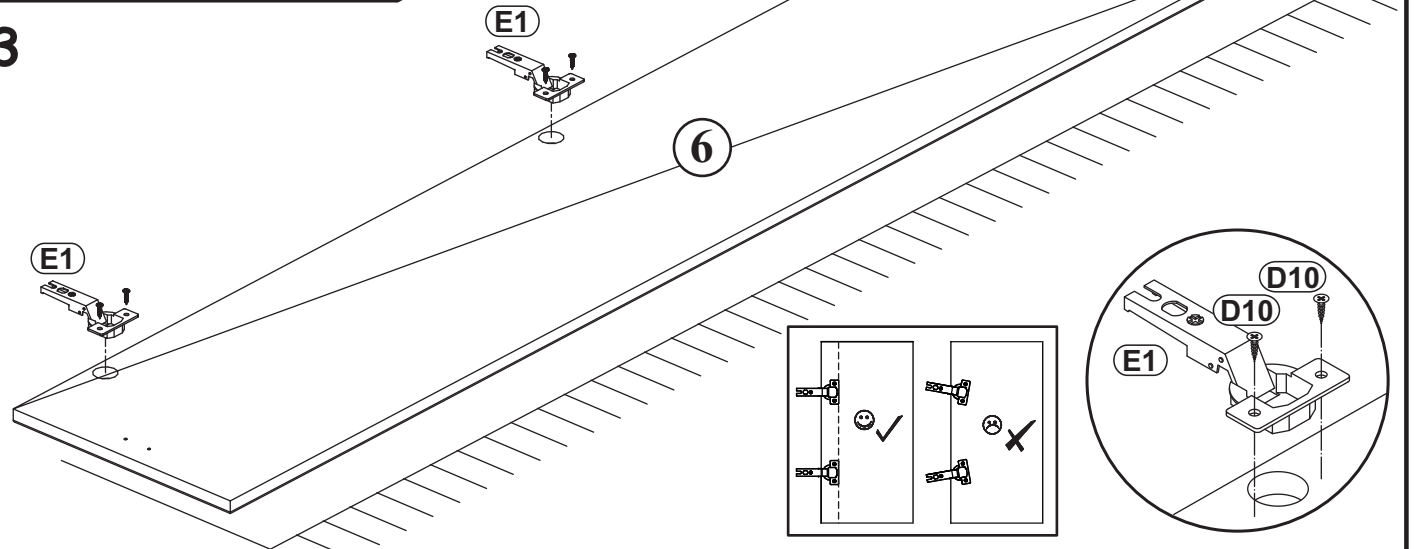

G5	
x16	

4

a)

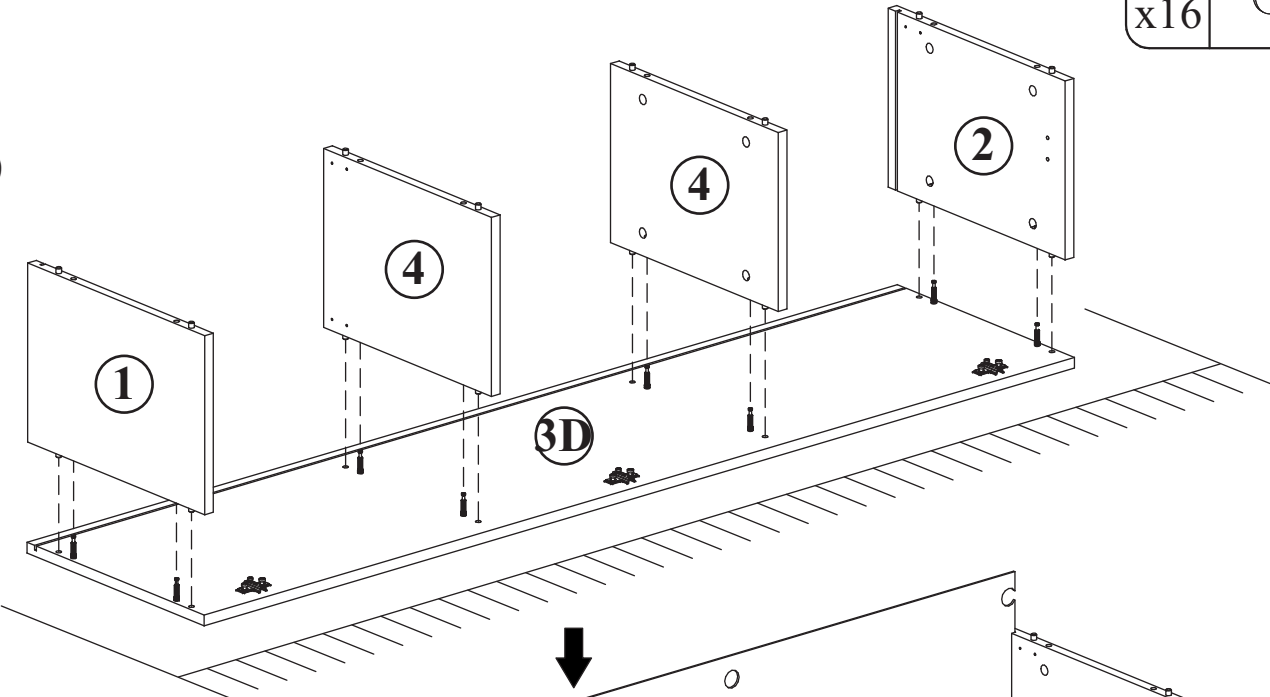

b)

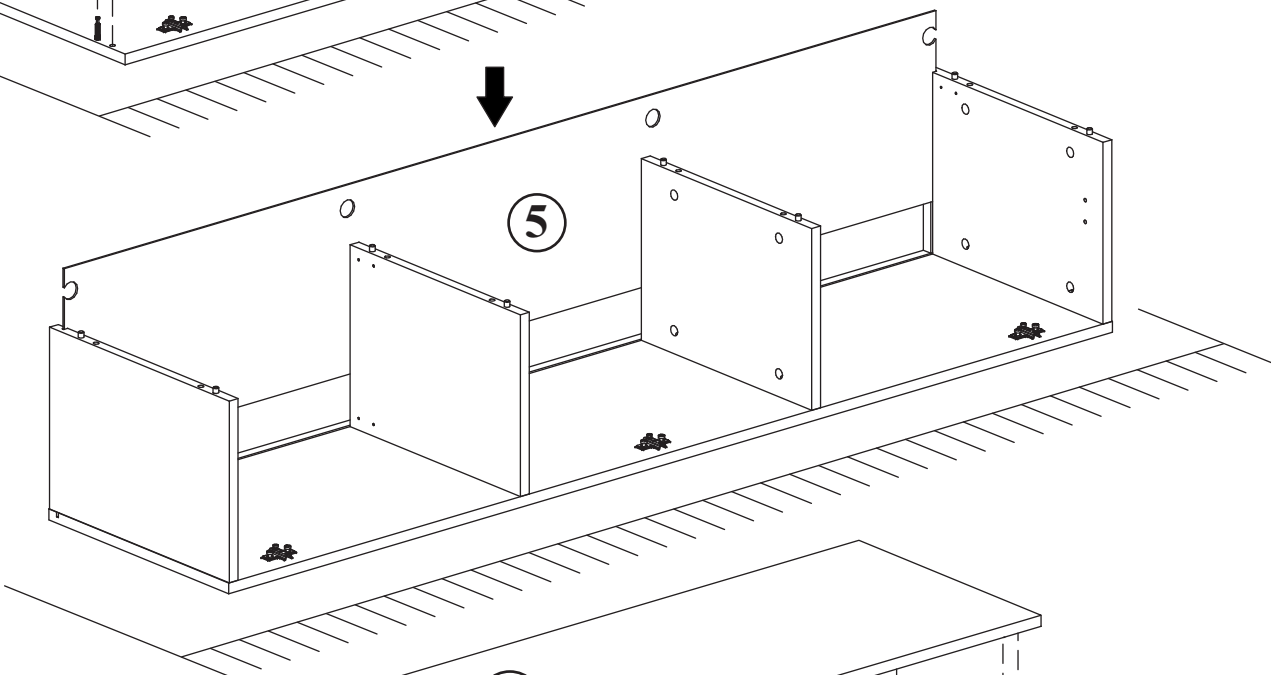

c)

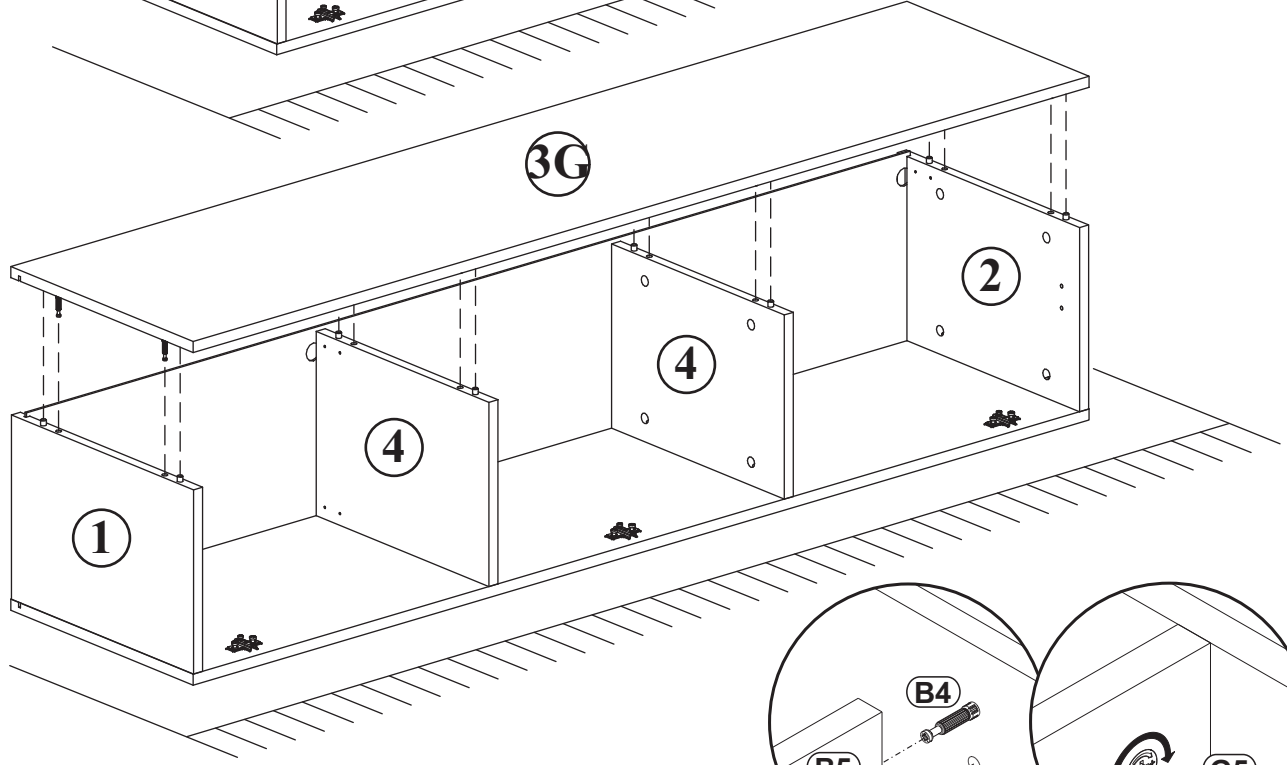

B4

B5

G5

FLY TYP-30

5

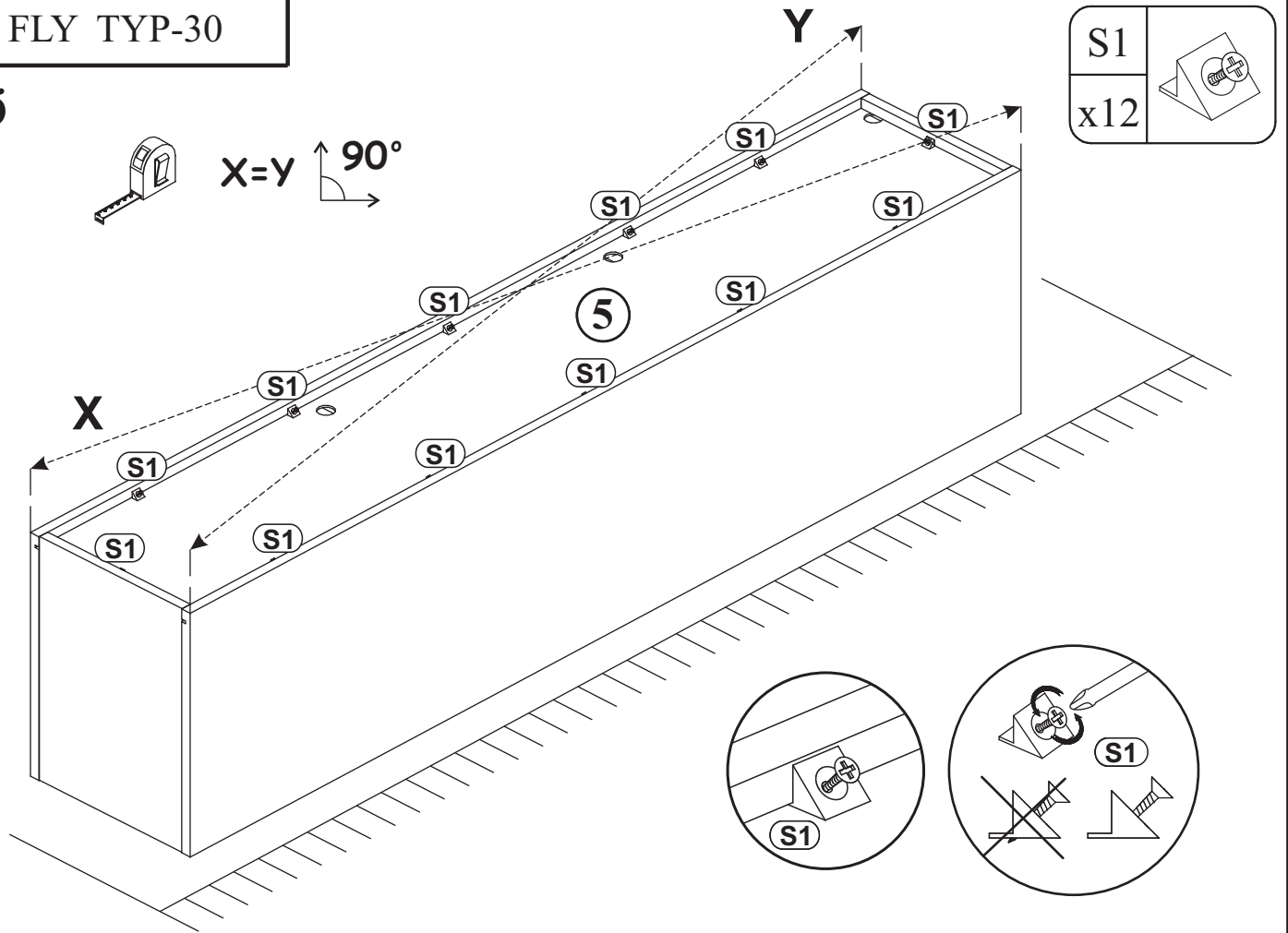

S1	
x12	

6

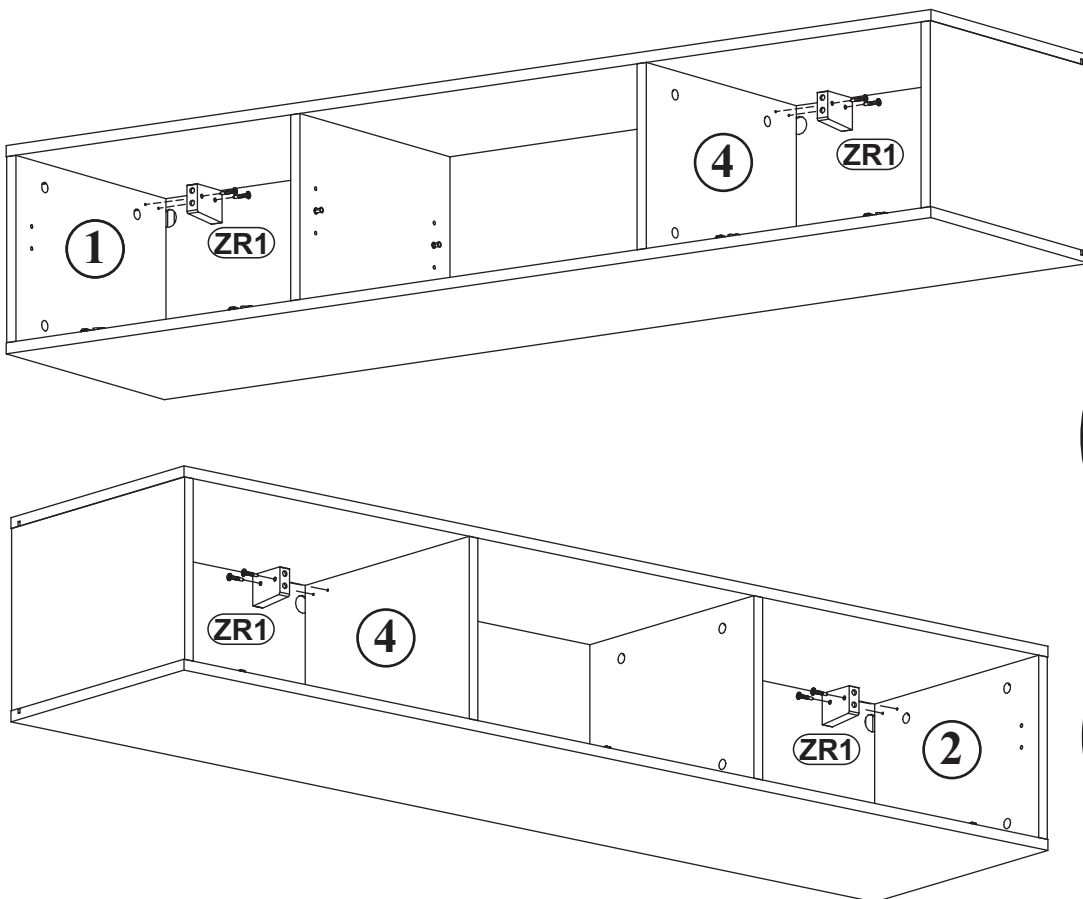

ZR1	
x4	

D6	
x8	USØ3,5x30

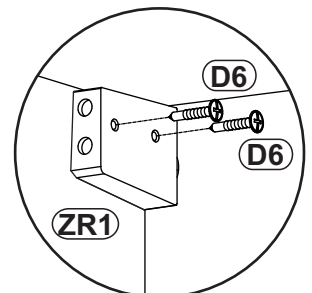
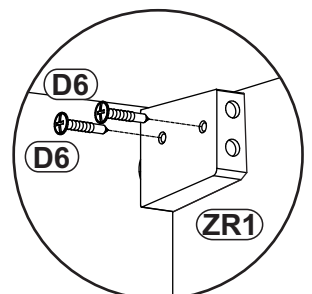

# FLY TYP-30

7

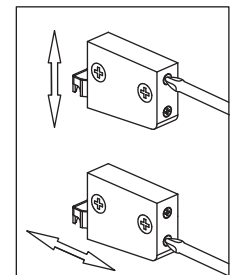
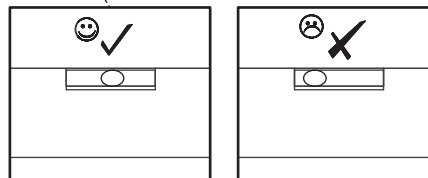
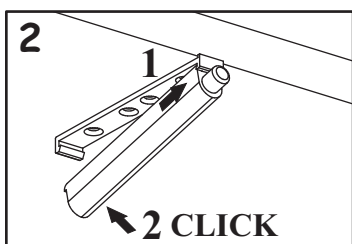
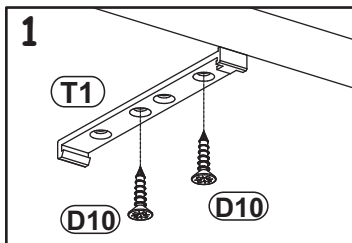
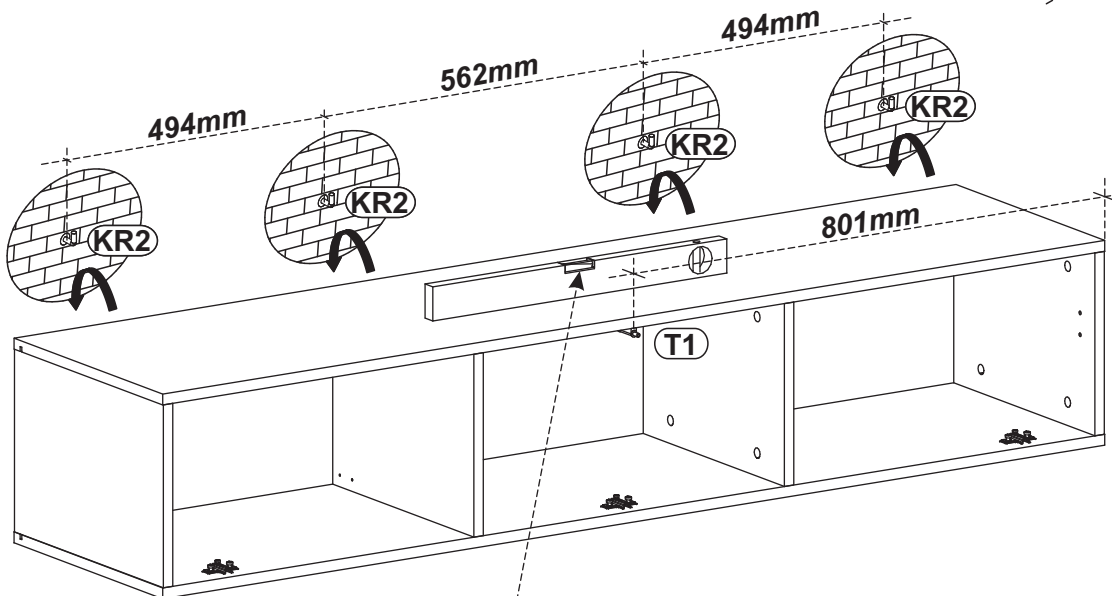
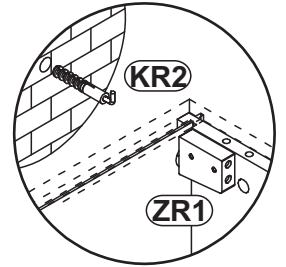
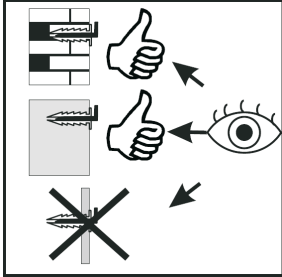
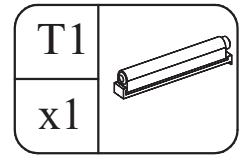
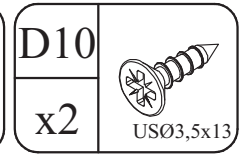
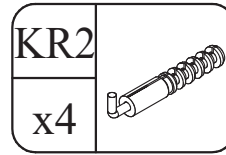
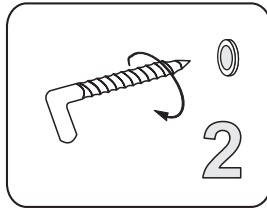
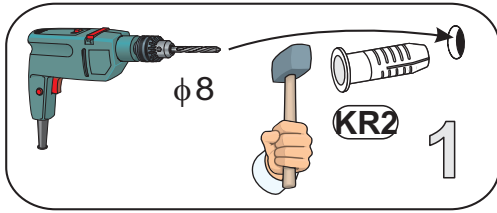

8

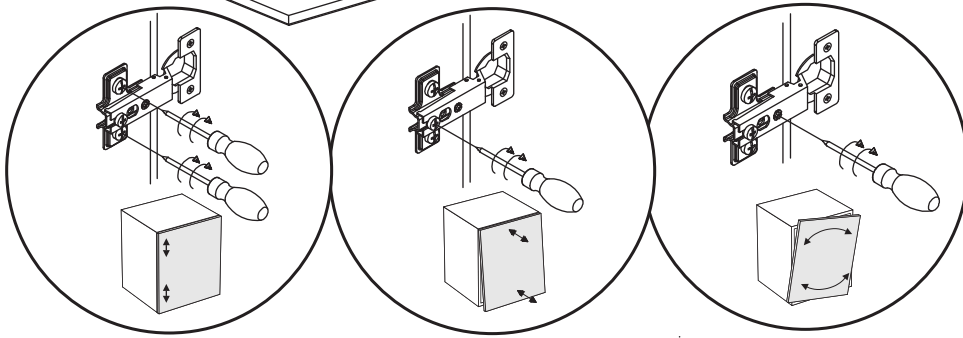
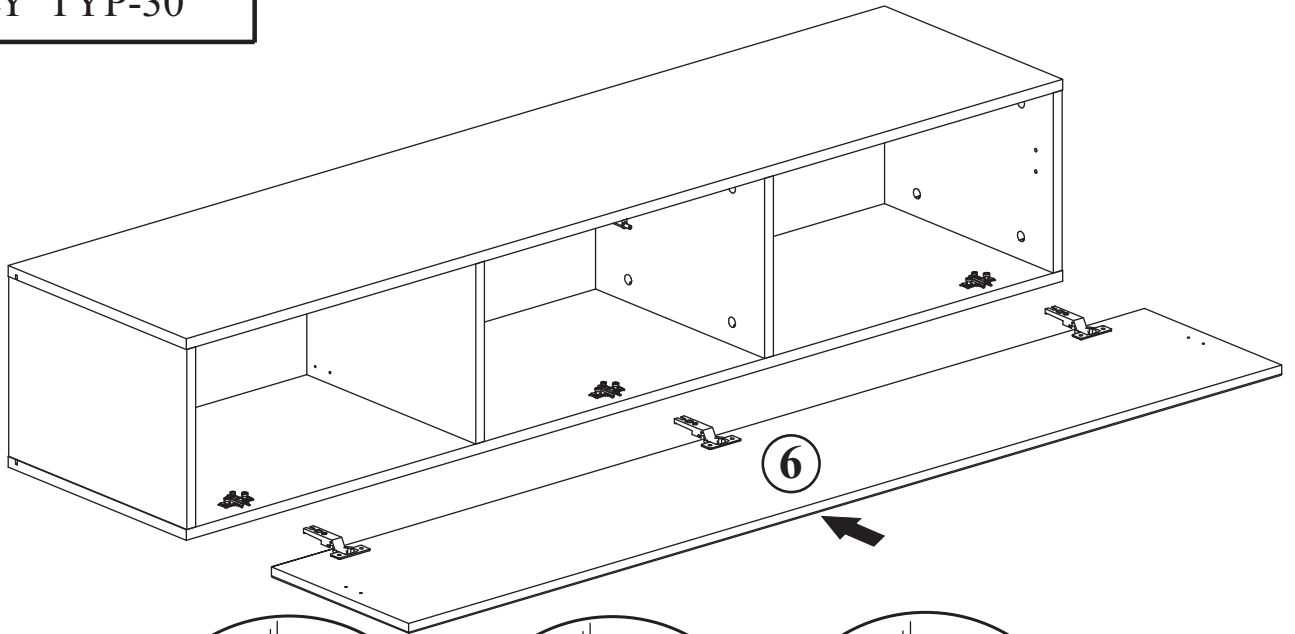

9

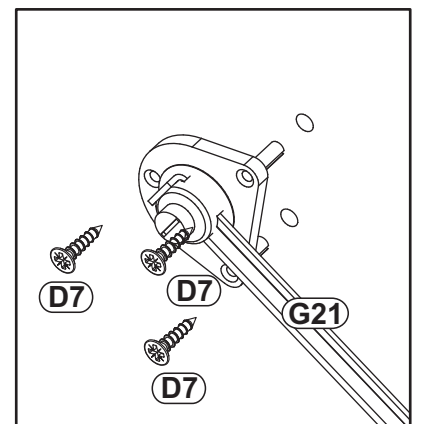
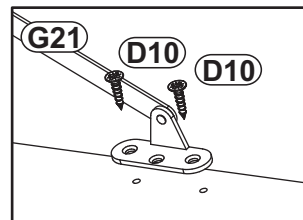
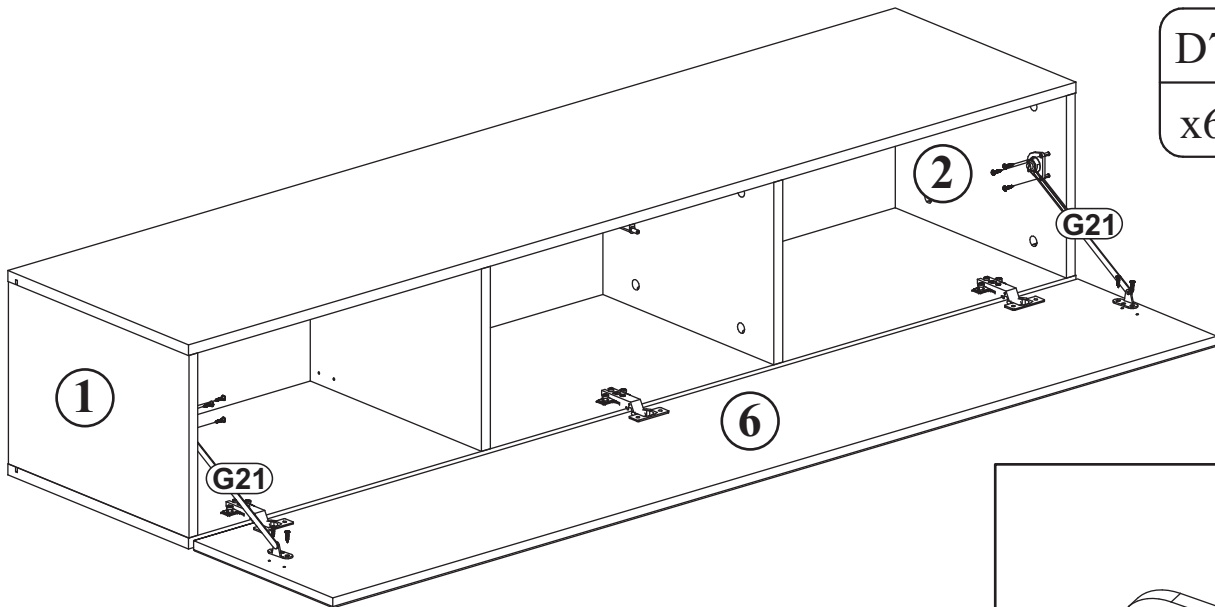
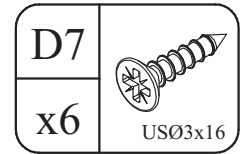
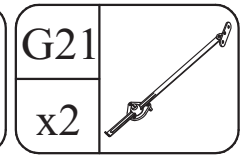
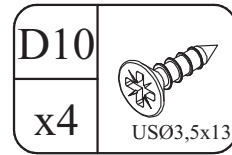



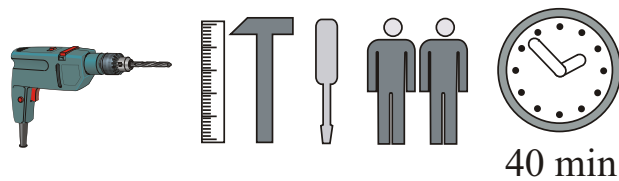
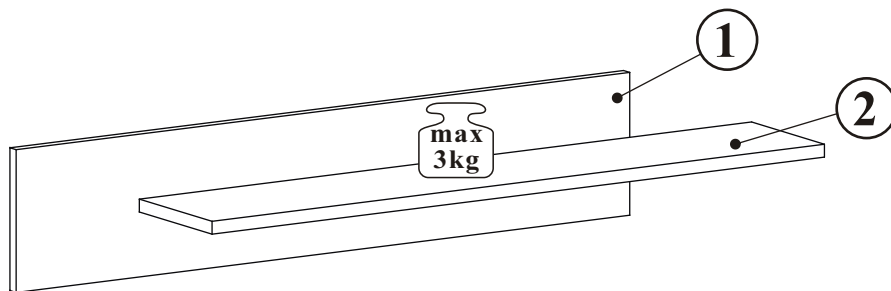
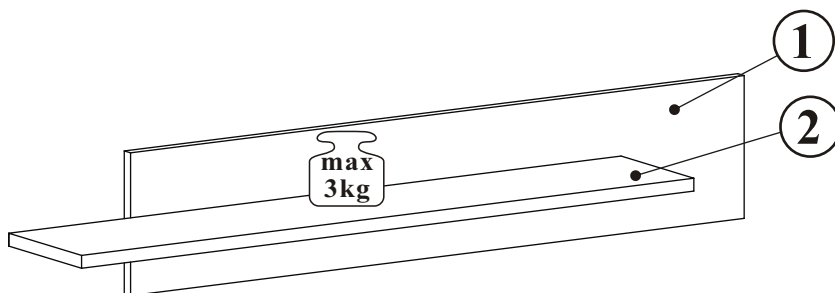
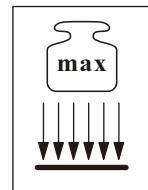
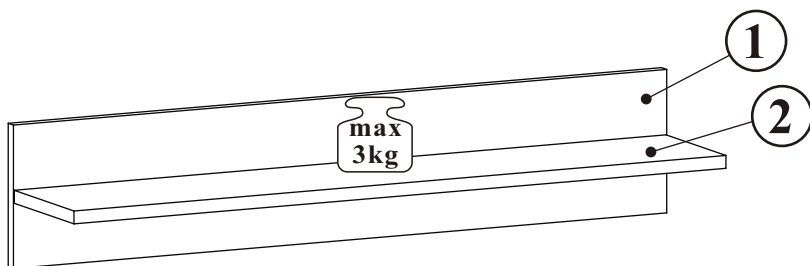



# GALINO 23\_MX

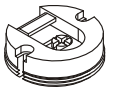

NO	Dim.		Col.-No	Qty
1	1002	200	1	2
2	1000	185	1	2

# GALINO 23\_MX

ZM1		D20		B11		G4		KR2		G2	
x4		x8	ESØ6x9,5	x12	Ø7x50	x12		x4		x1	

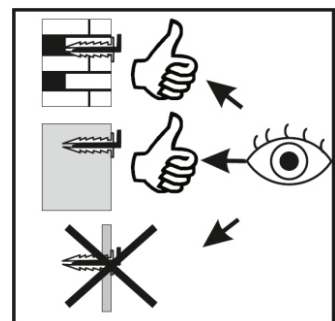
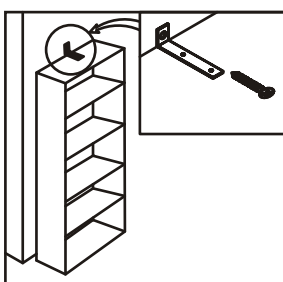
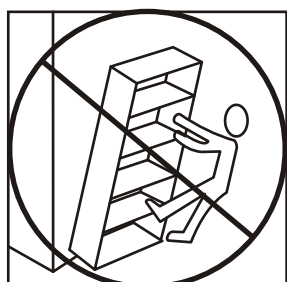
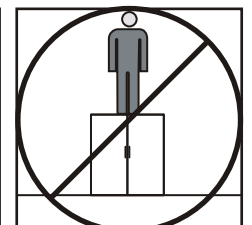
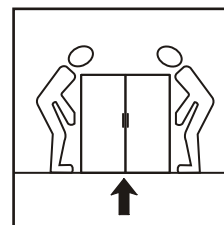
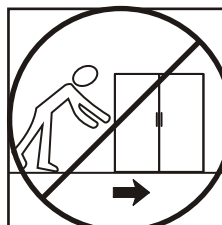
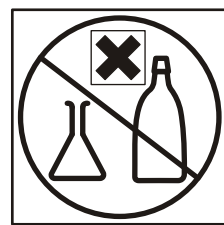
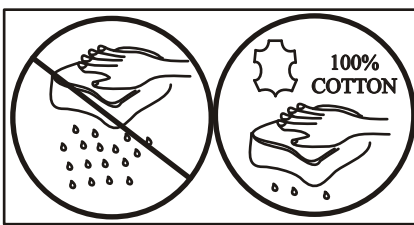
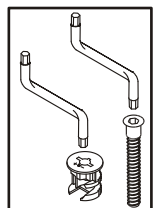
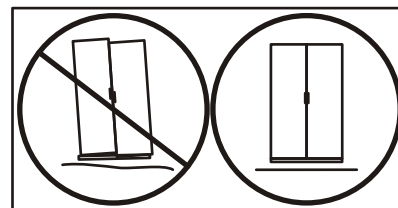
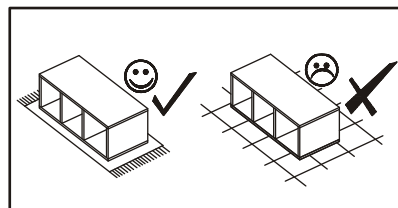
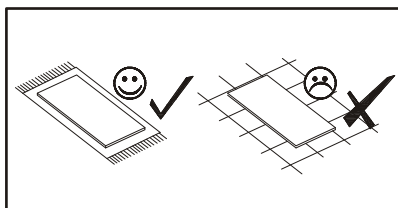
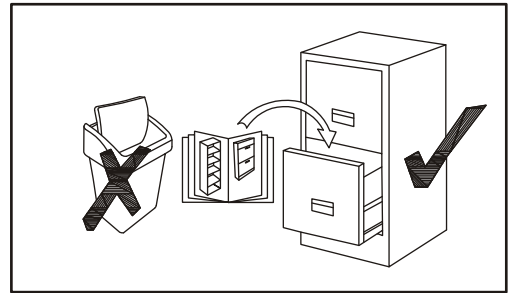
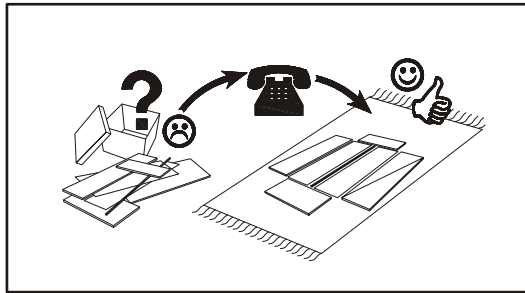
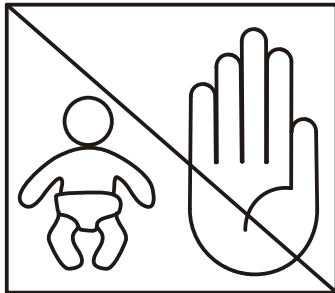
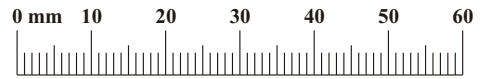

**1-3**

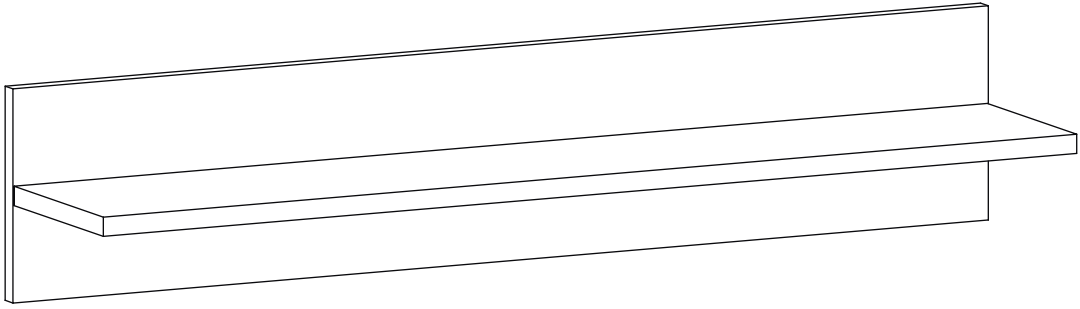

**4-6**

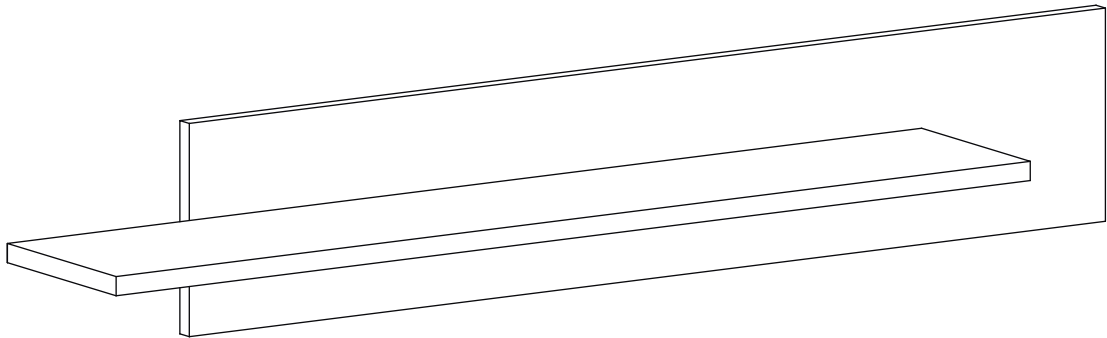

**7-9**

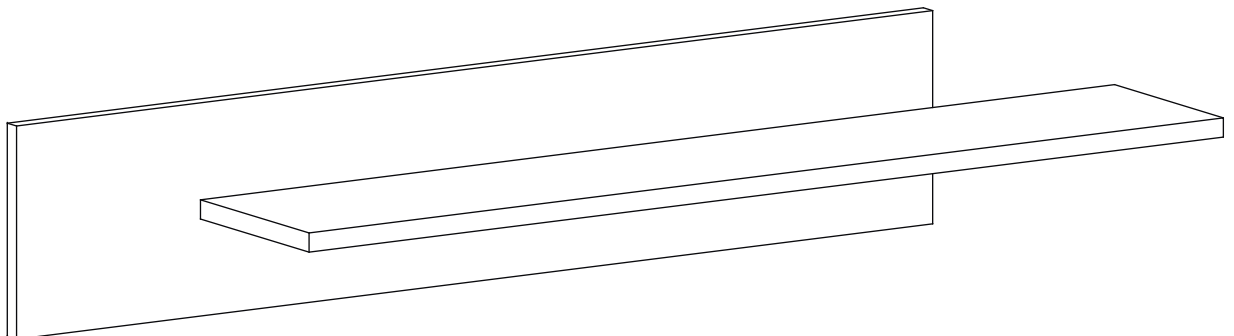

GALINO 23\_MX

1

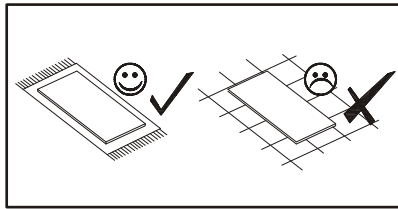

ZM1  
x4

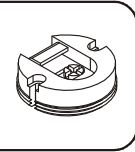

D20  
x8

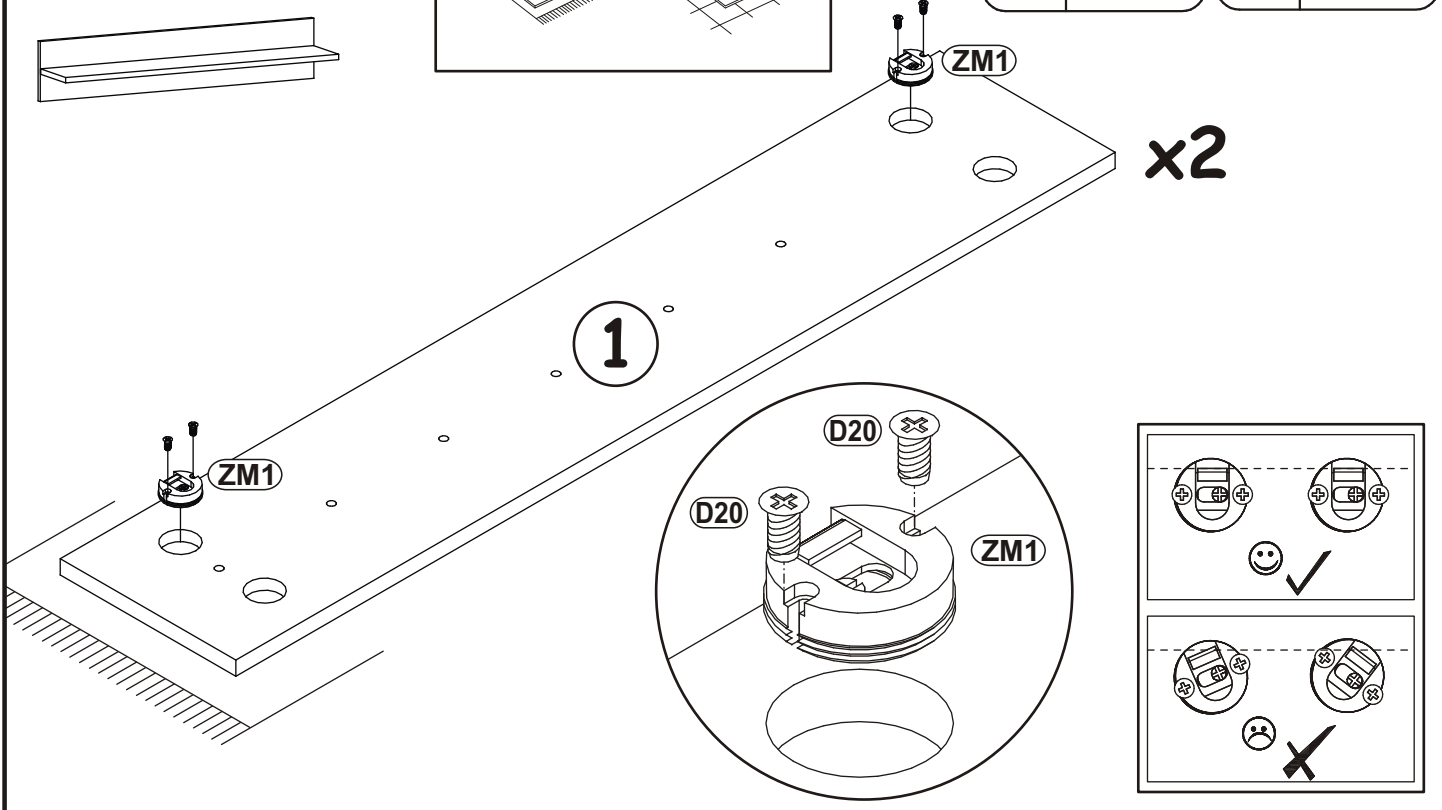
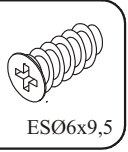

2

B11  
x12

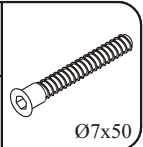

G4  
x12

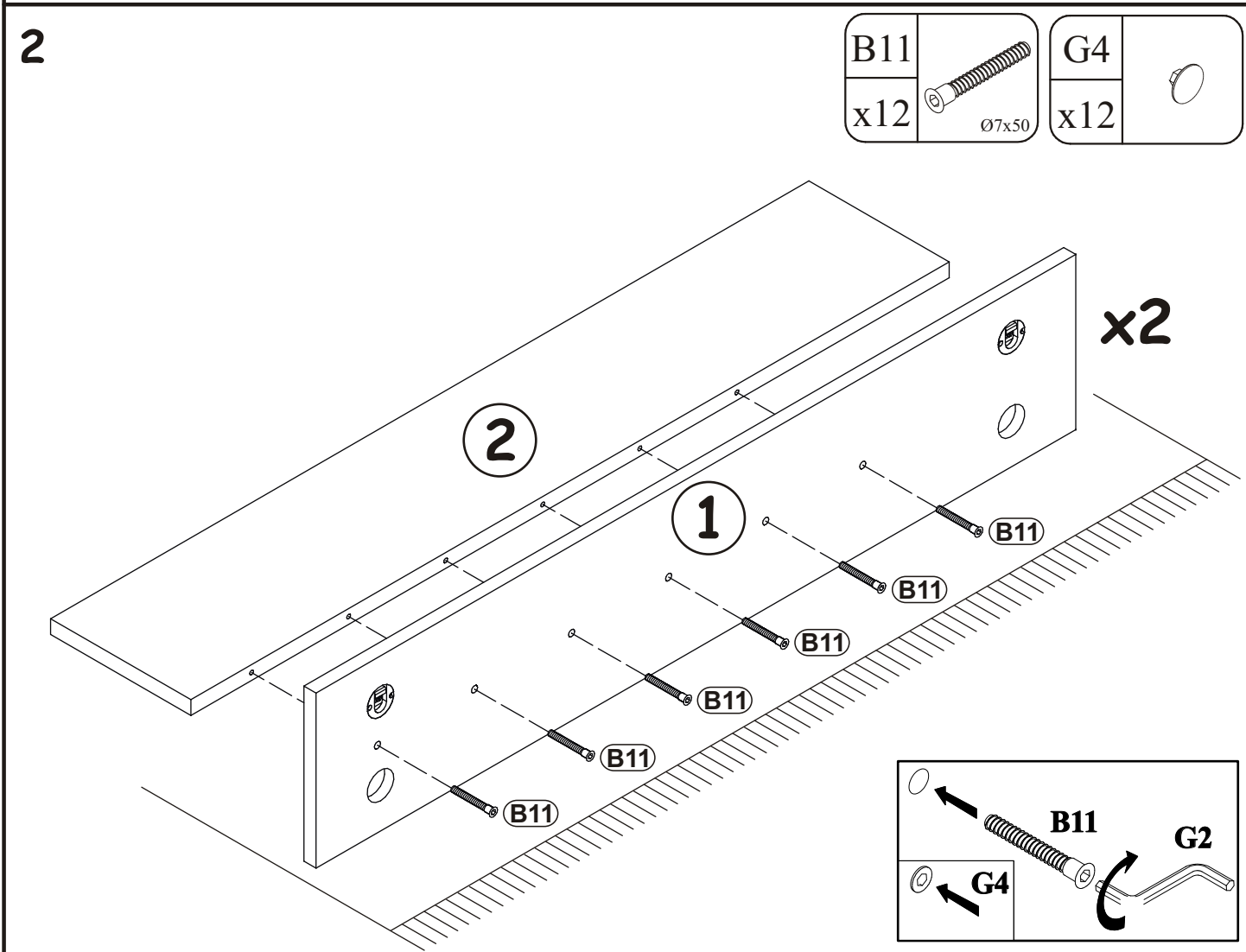
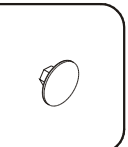

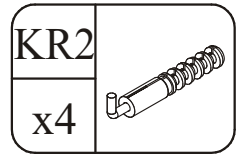

3

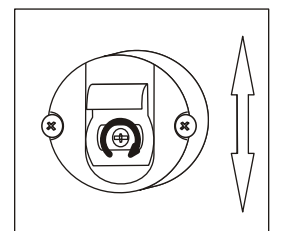
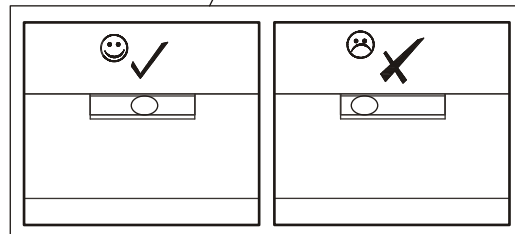
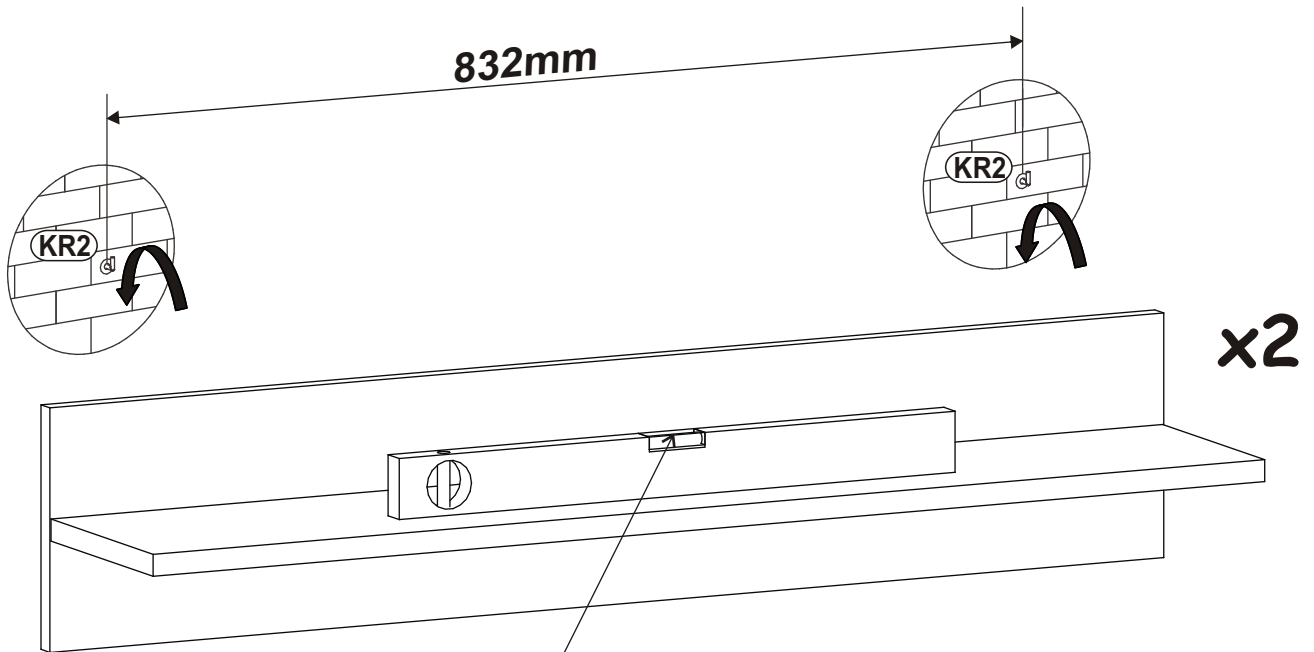
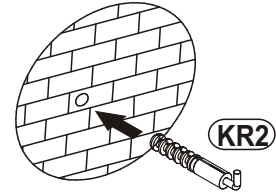
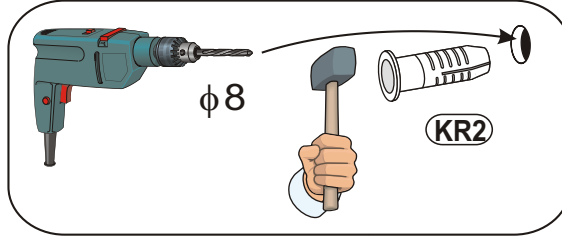
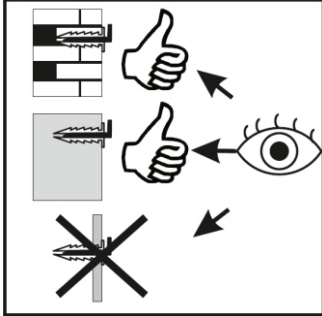

4

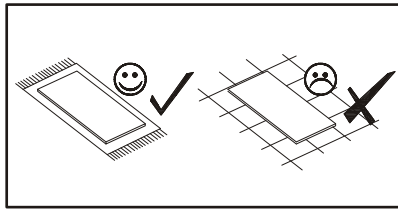

ZM1		D20	
x4		x8	ESØ6x9,5

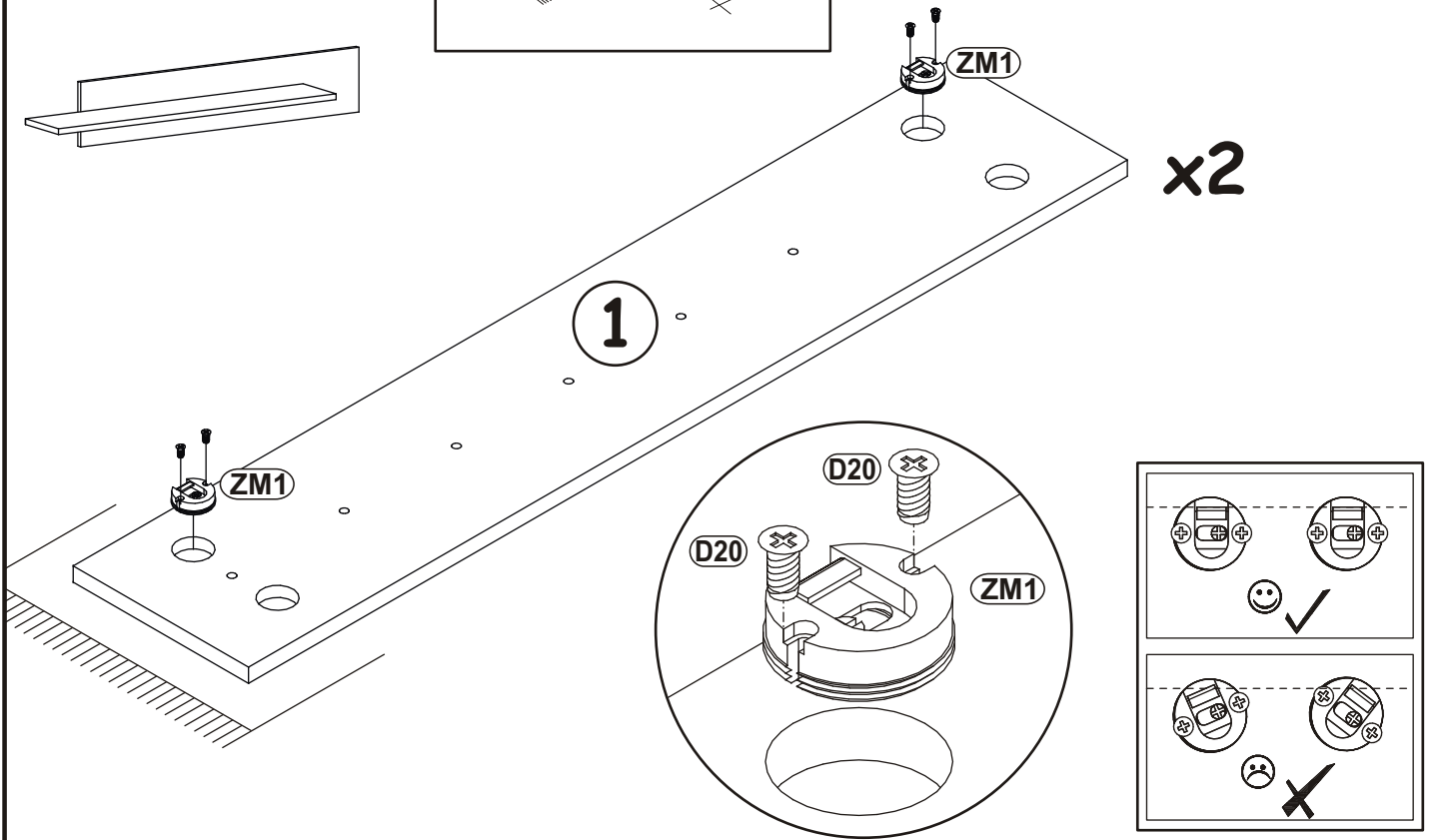

5

B11		G4	
x12	Ø7x50	x12	

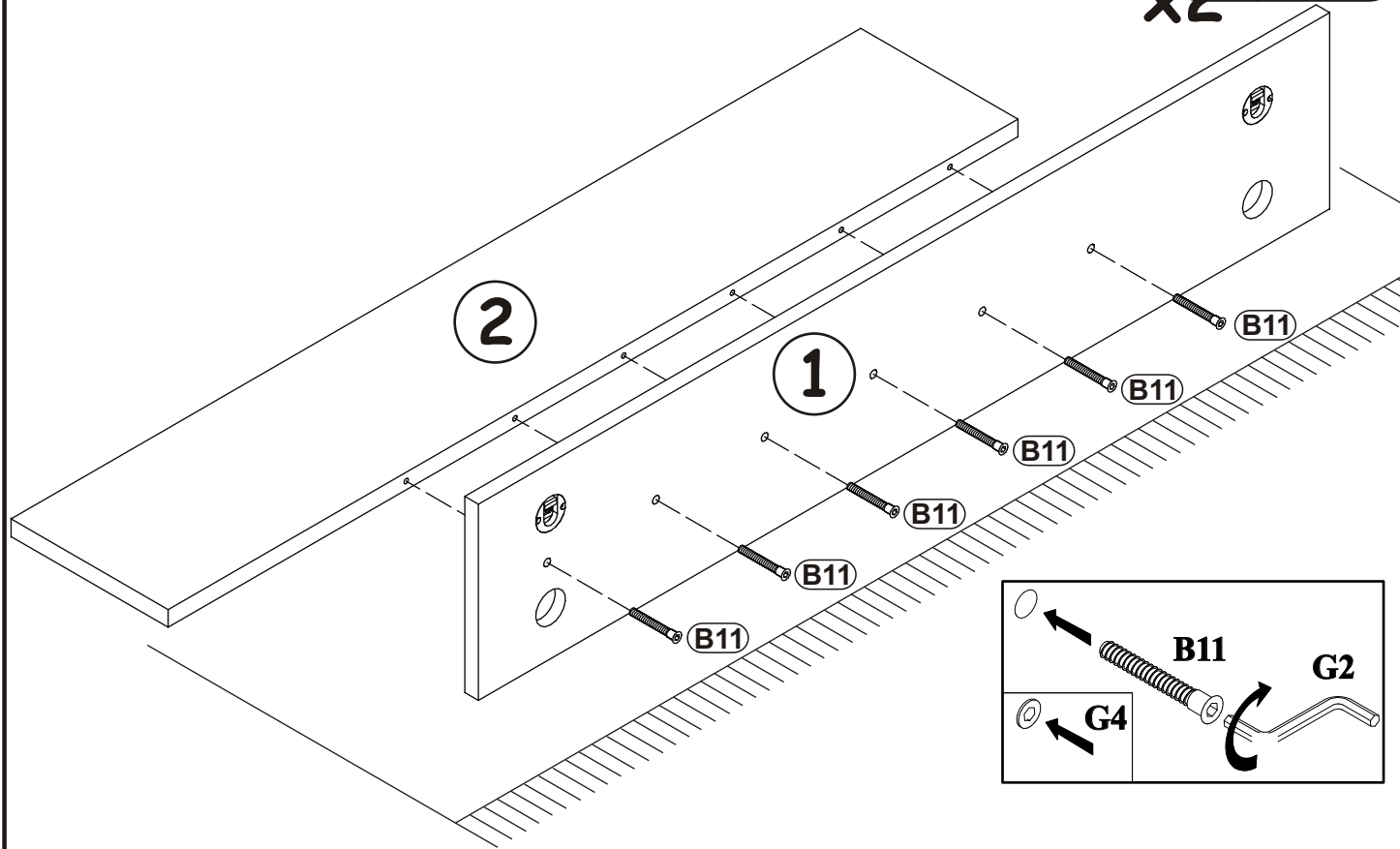

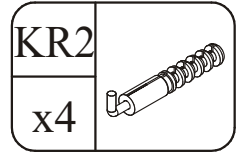

6

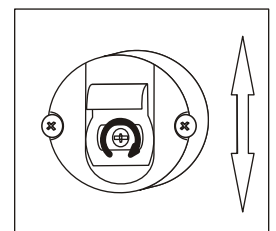
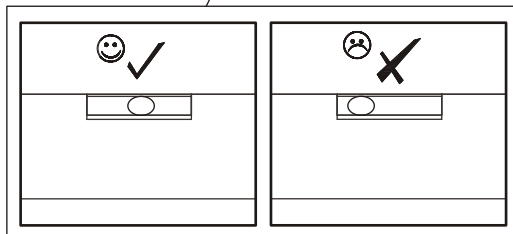
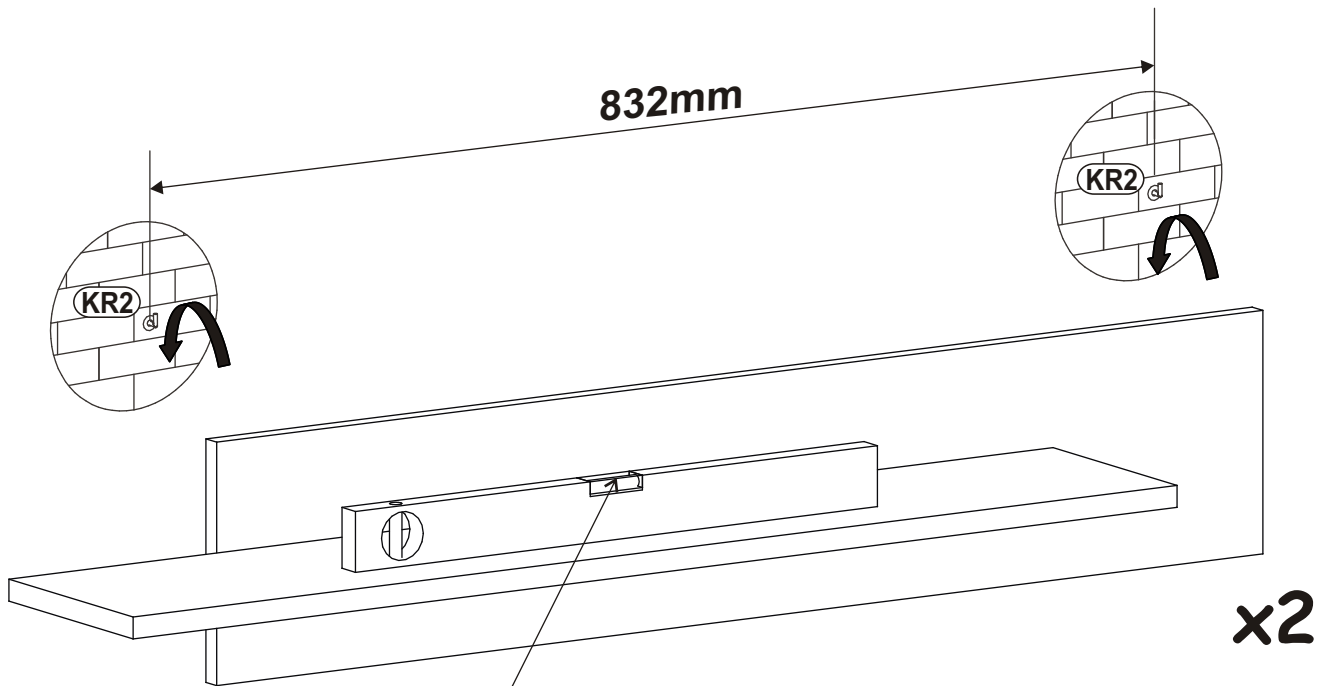
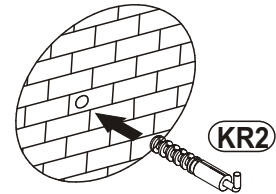
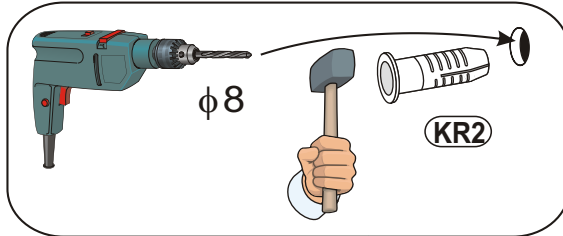
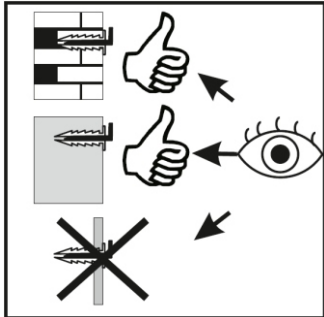

7

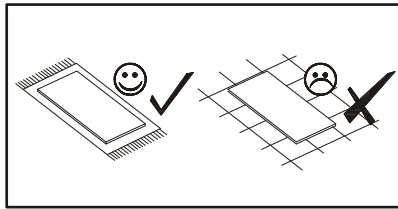

ZM1		D20	
x4		x8	

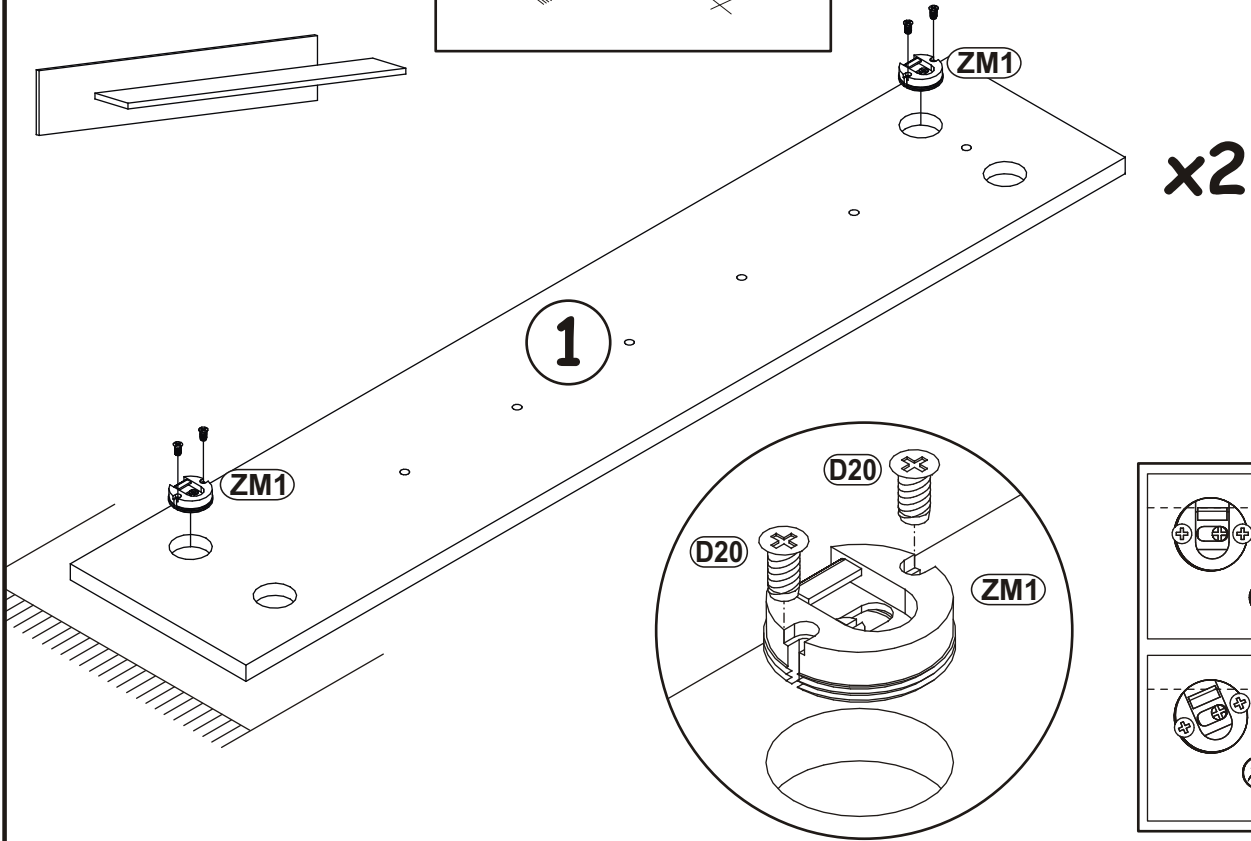

8

B11		G4	
x12	Ø7x50	x12	

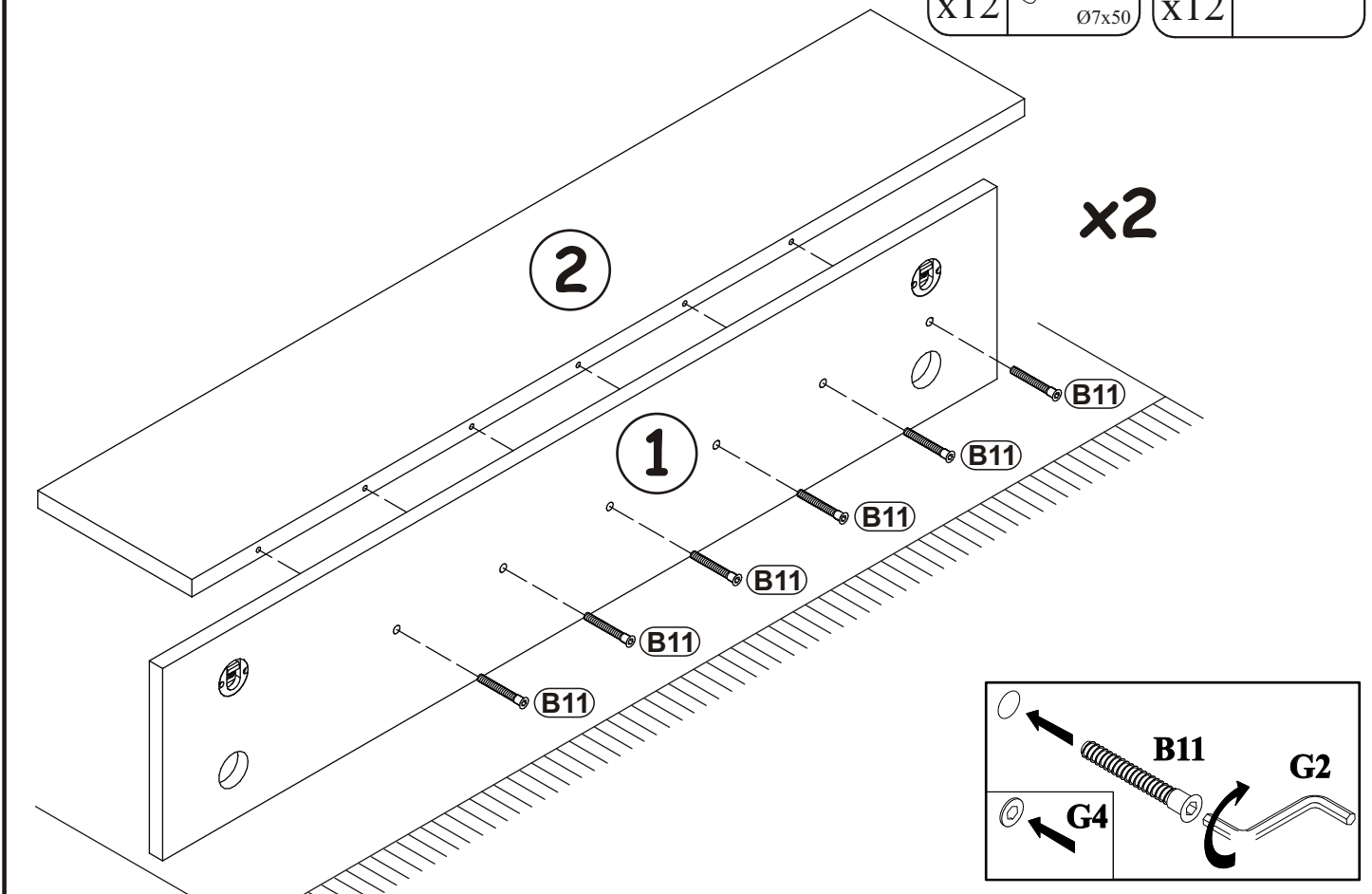

9

