



LE TRI + FACILE



FR

Pensez à donner ou recycler.



ou



ou



<https://quefairedemesdechets.fr>

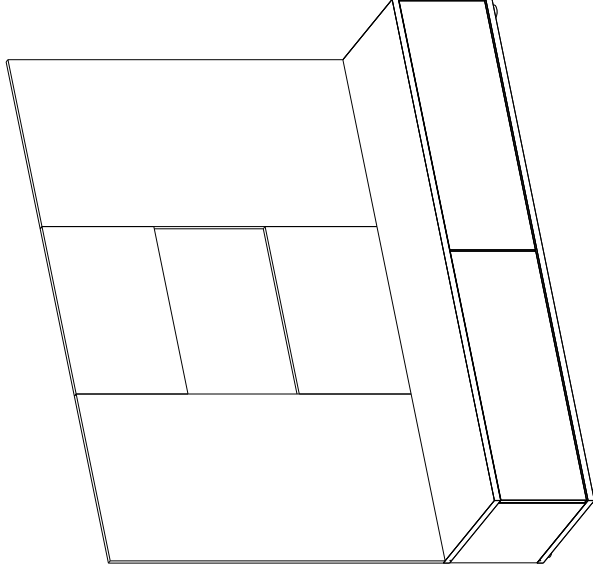
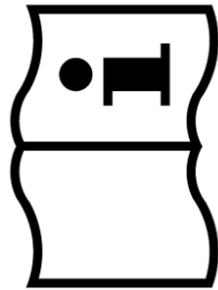

120 min

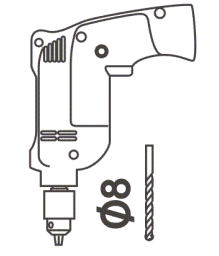
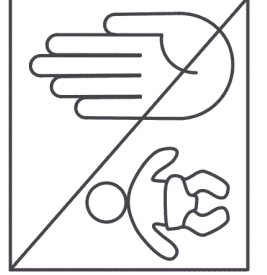
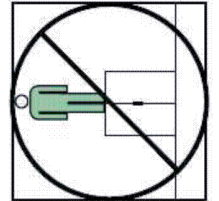
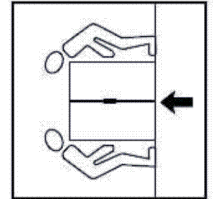
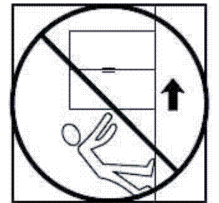
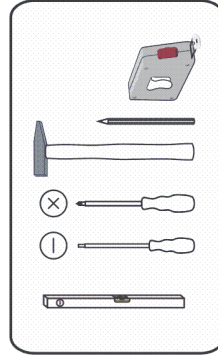
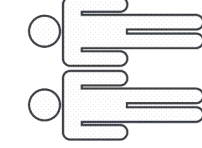
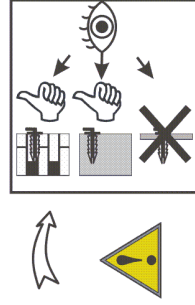
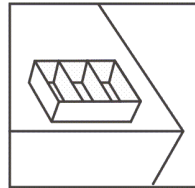
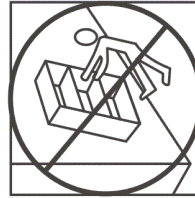
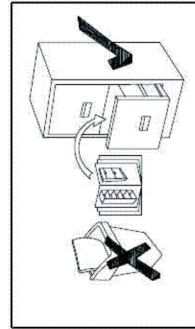
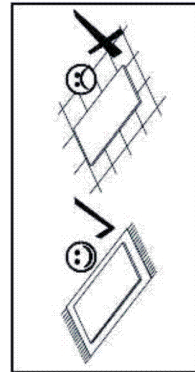

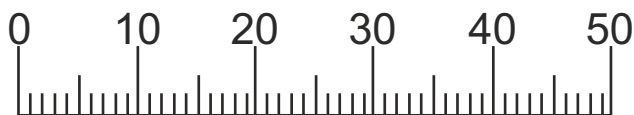
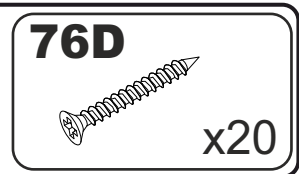
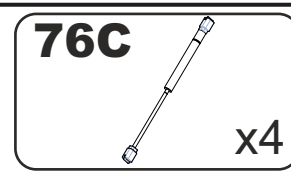
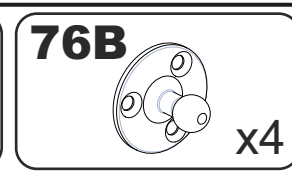
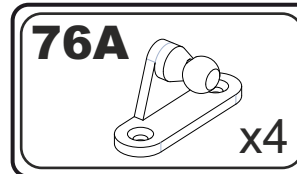
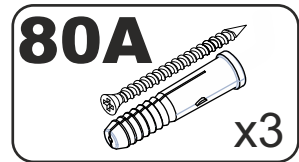
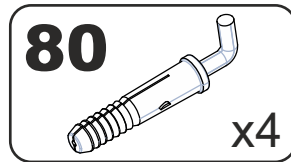
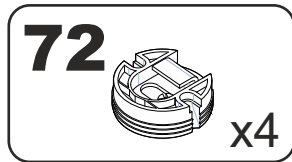
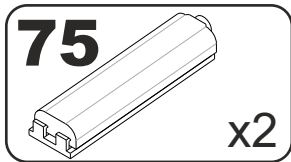
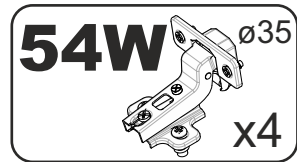
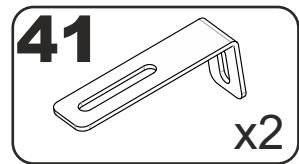
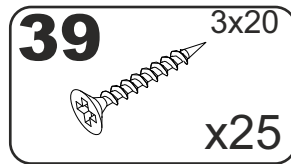
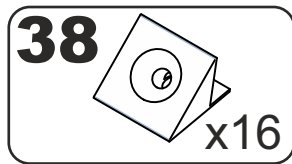
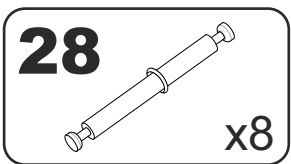
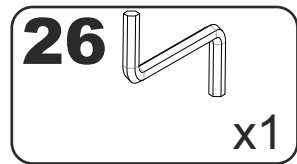
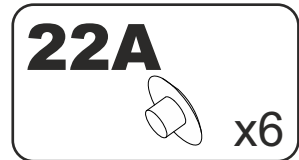
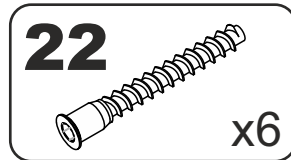
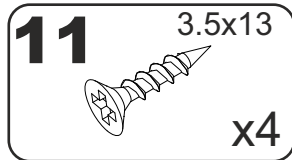
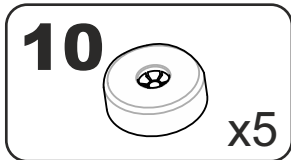
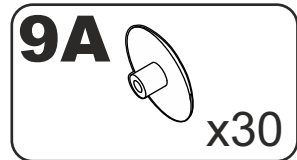
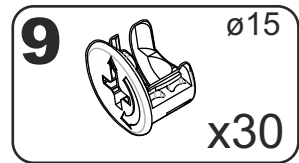
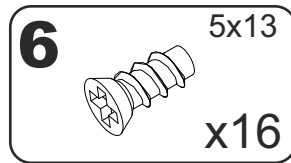
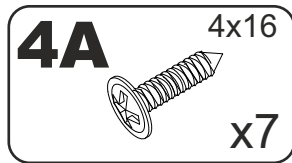
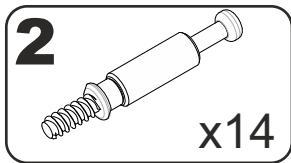
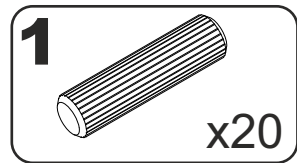
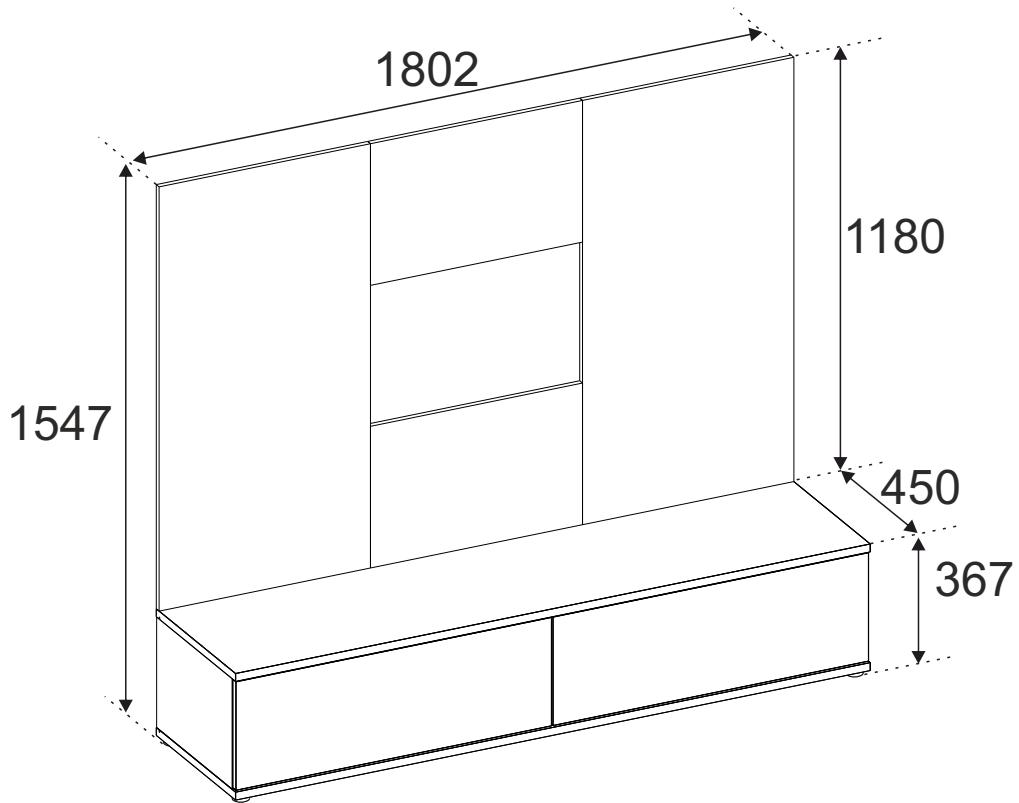
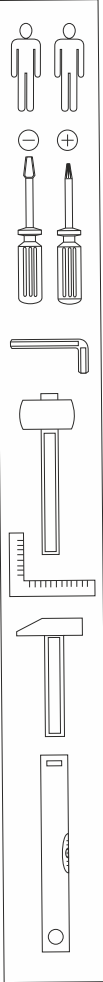

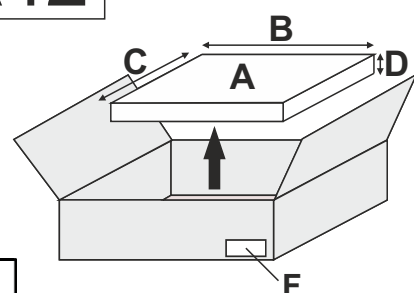
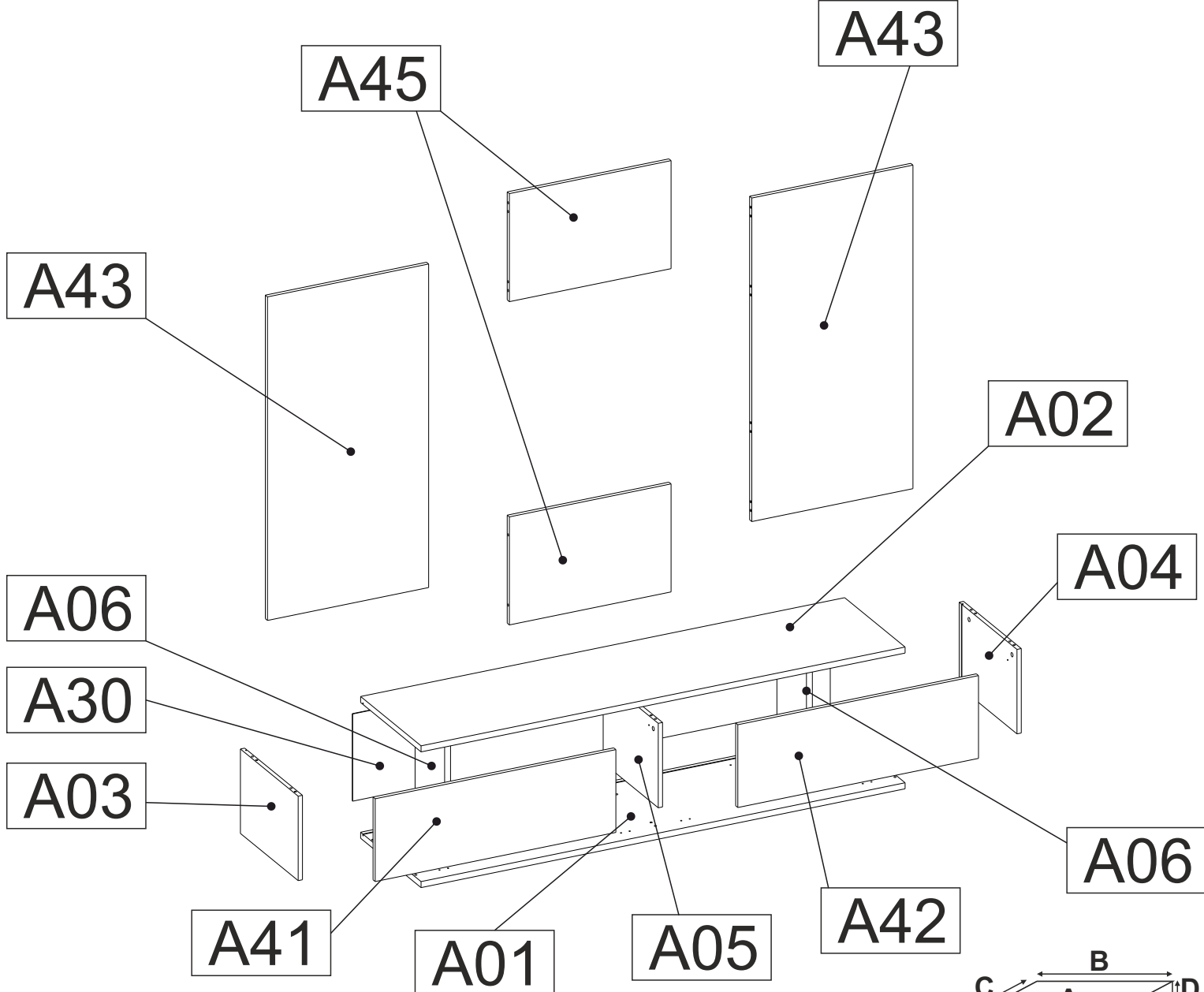

A	B_(mm)	C_(mm)	D_(mm)	E	F
A01	1802	450	22	1	2 2
A02	1802	450	22	1	2 2
A03	308	430	16	1	1 2
A04	308	430	16	1	1 2
A05	308	410	16	1	1 2
A06	308	220	22	2	1 2
A30	1778	318	3	1	2 2
A41	896	302	16	1	2 2
A42	896	302	16	1	2 2
A43	1180	600	16	2	1 2
A45	394	602	16	2	1 2

1

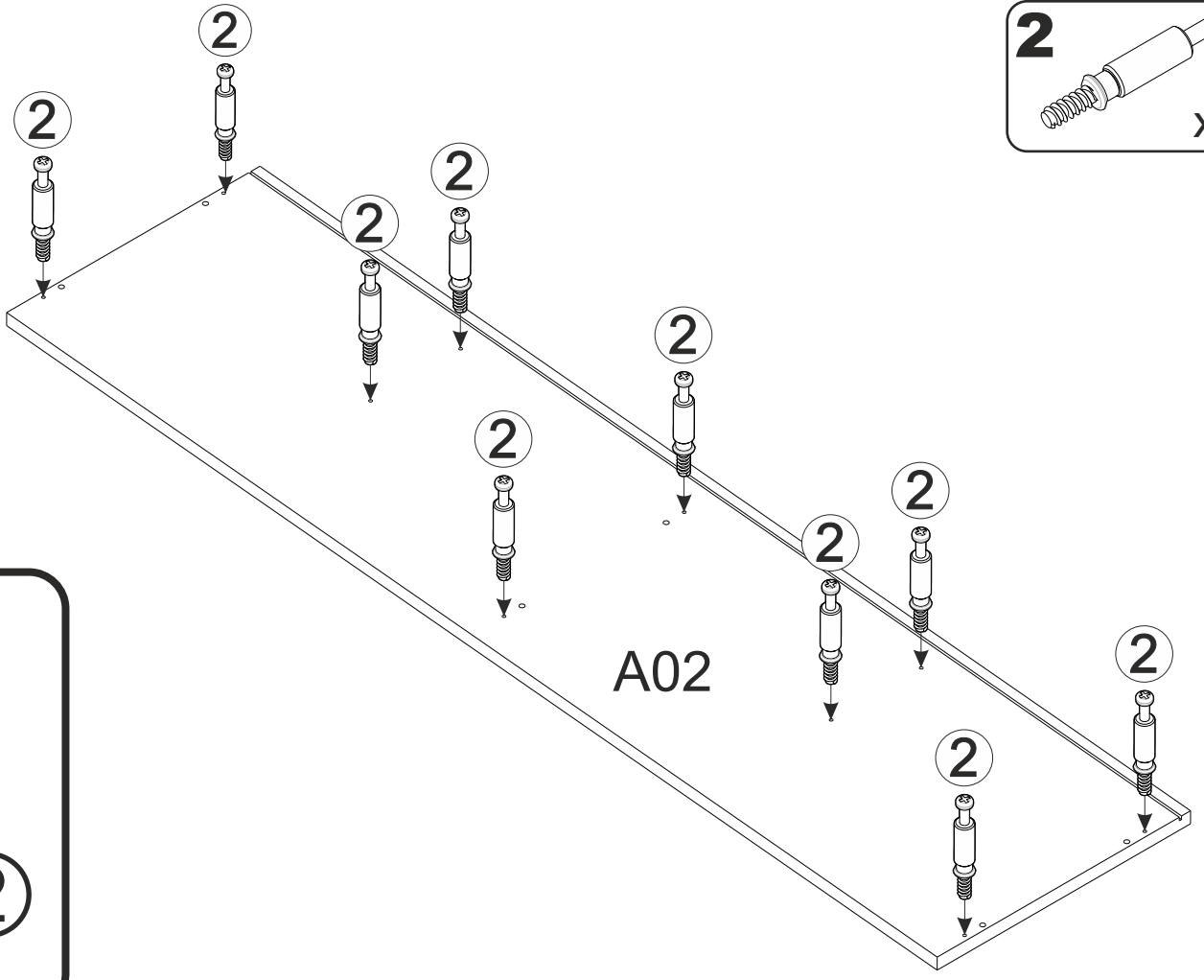

2

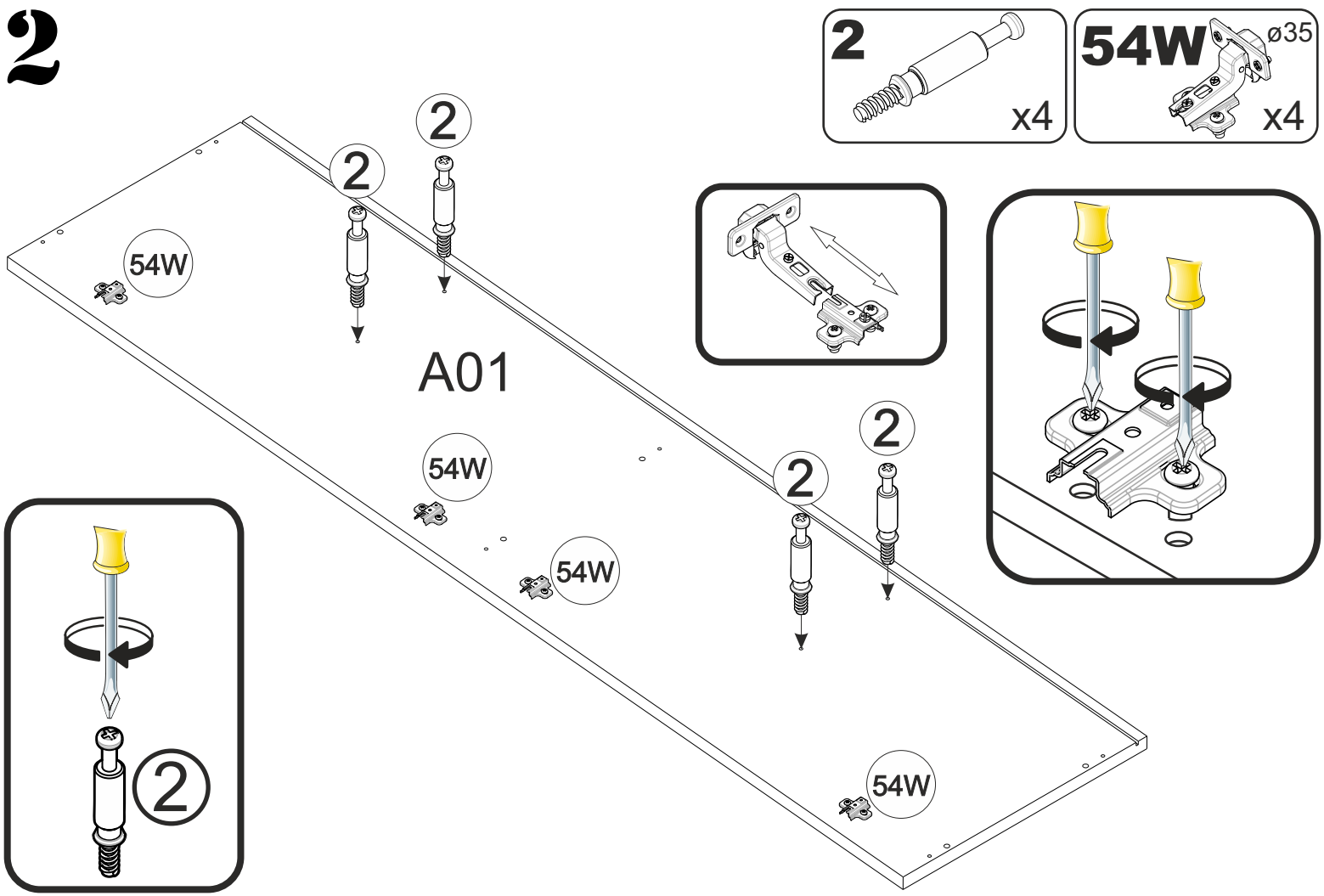

3

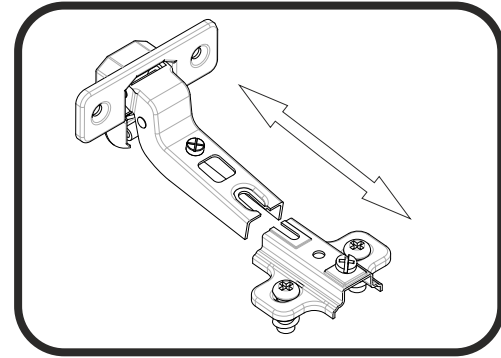
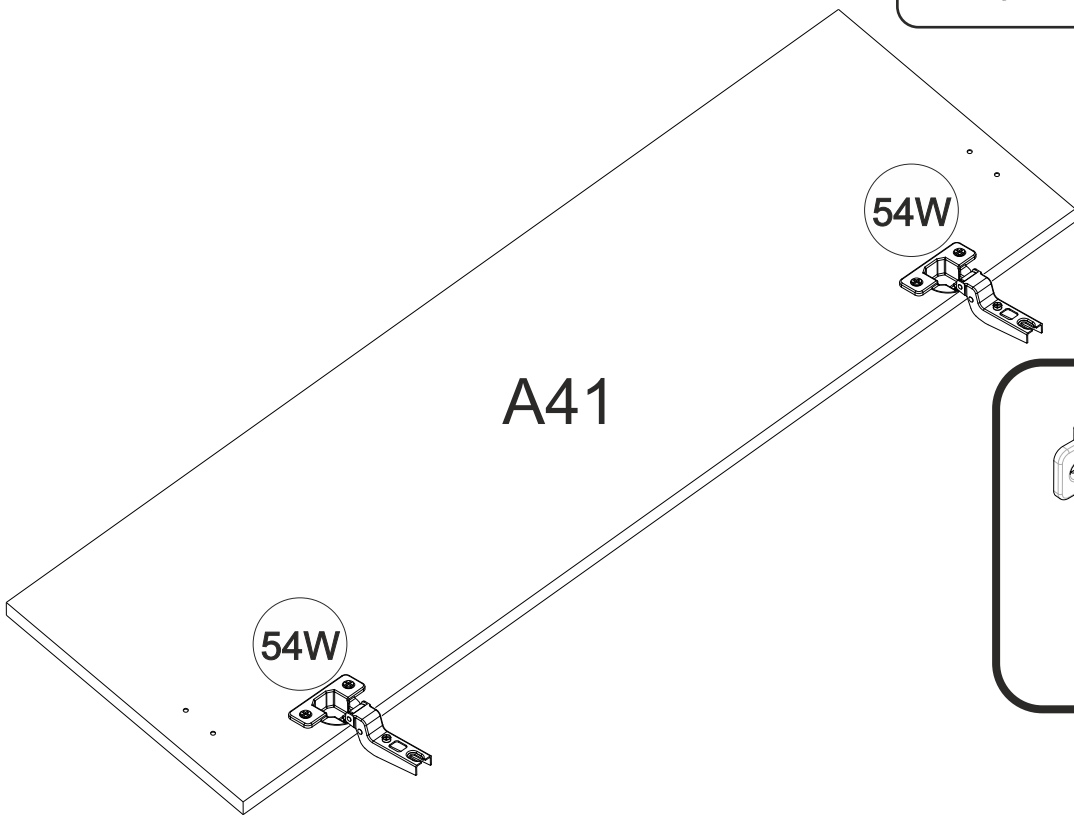
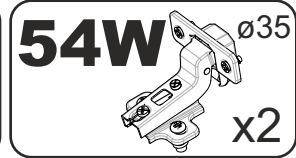
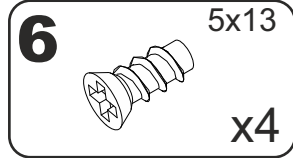

4

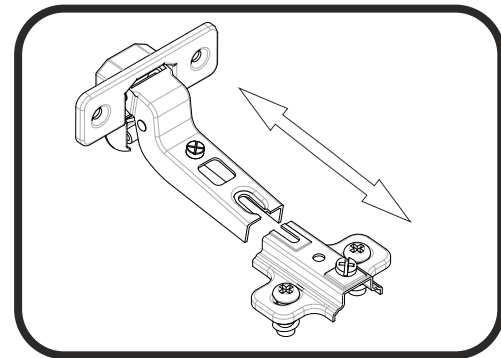
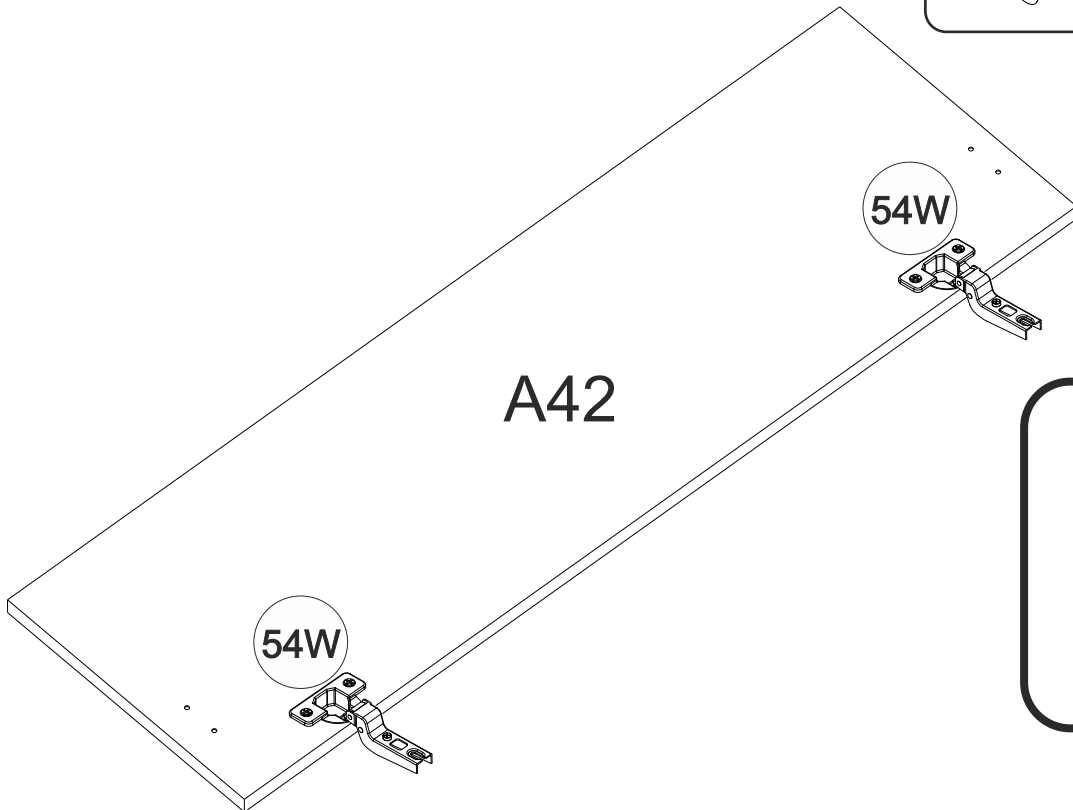
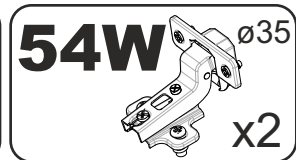
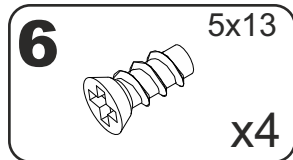

5

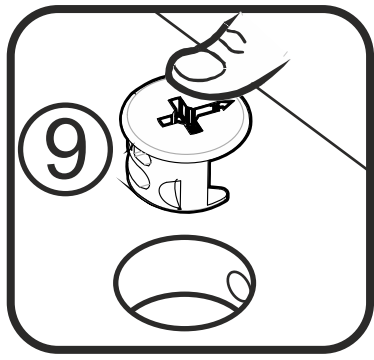
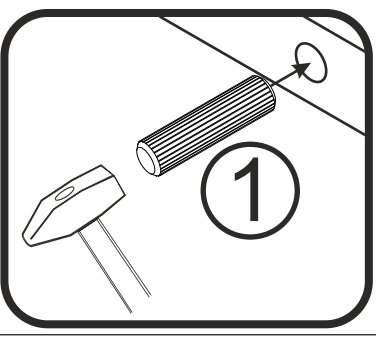
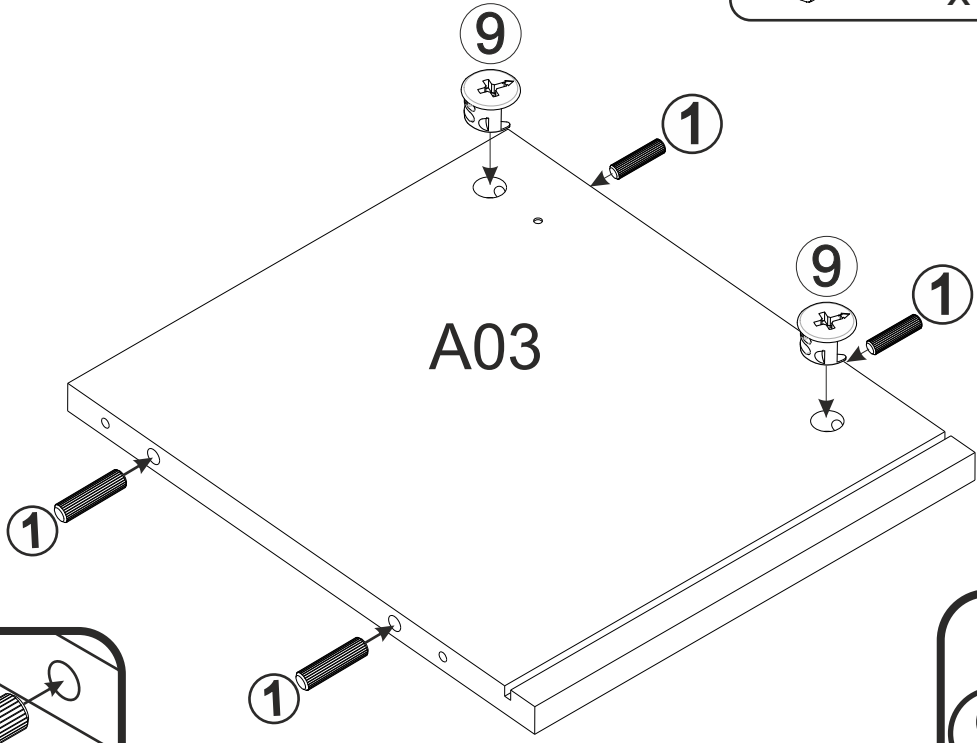
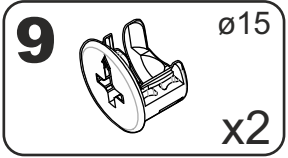
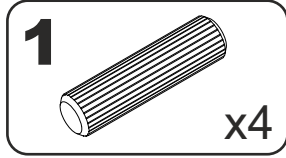

6

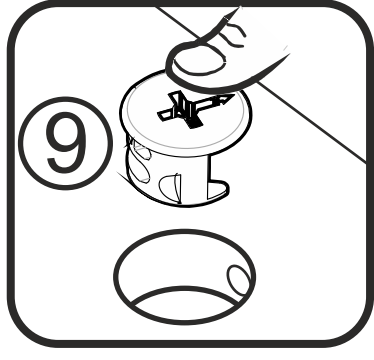
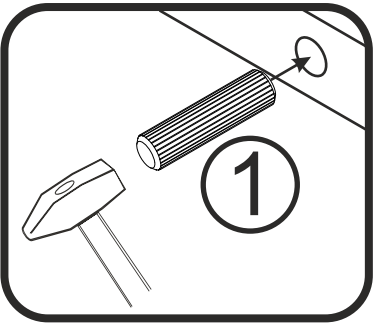
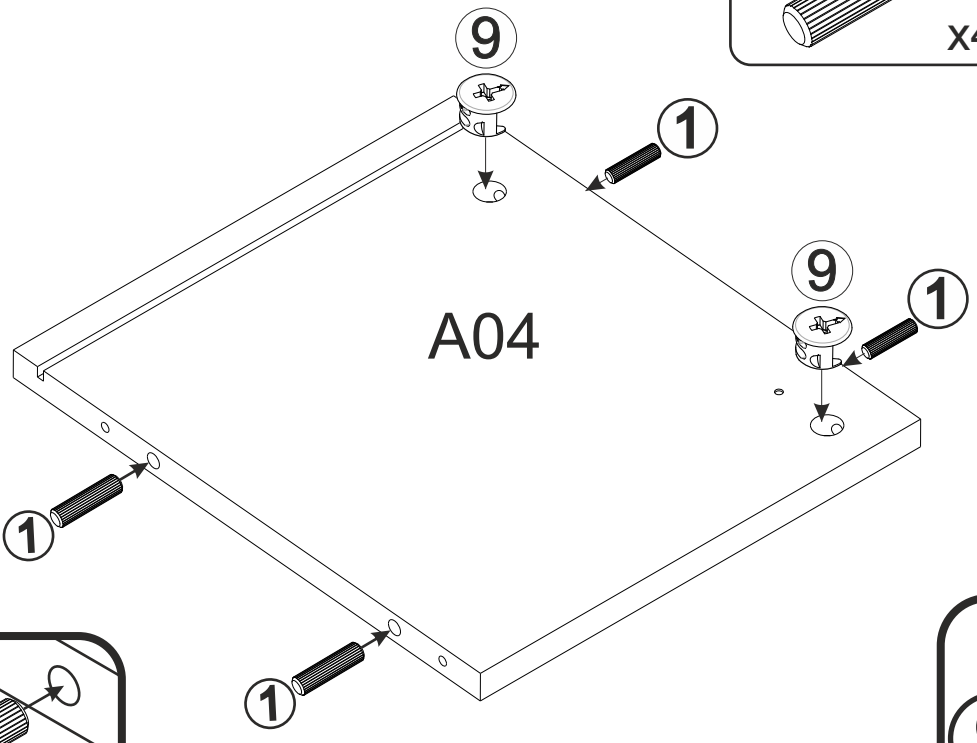
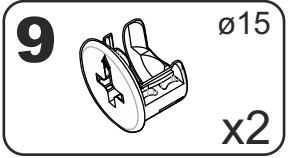
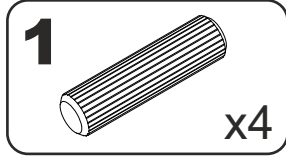

7

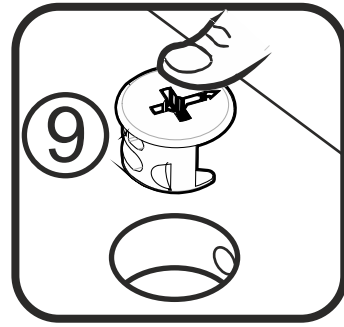
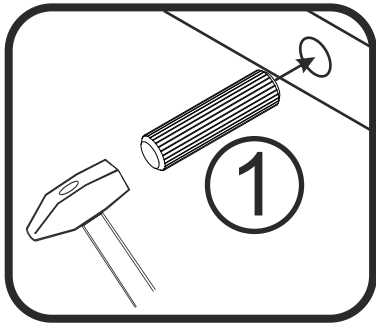
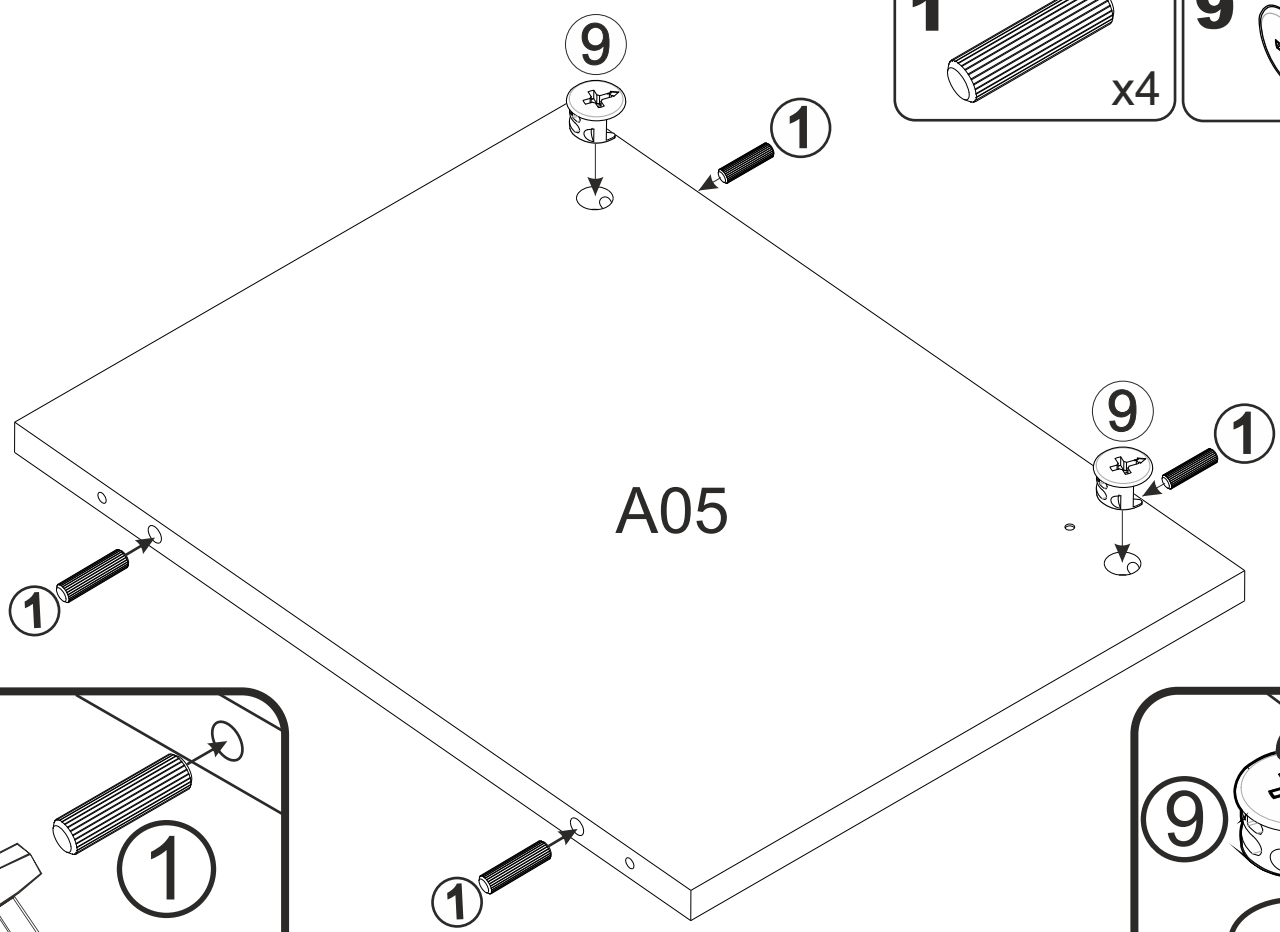
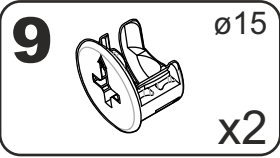
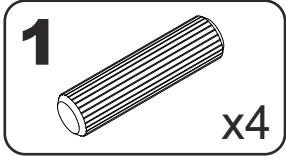

8

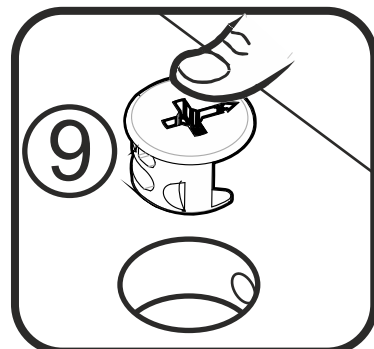
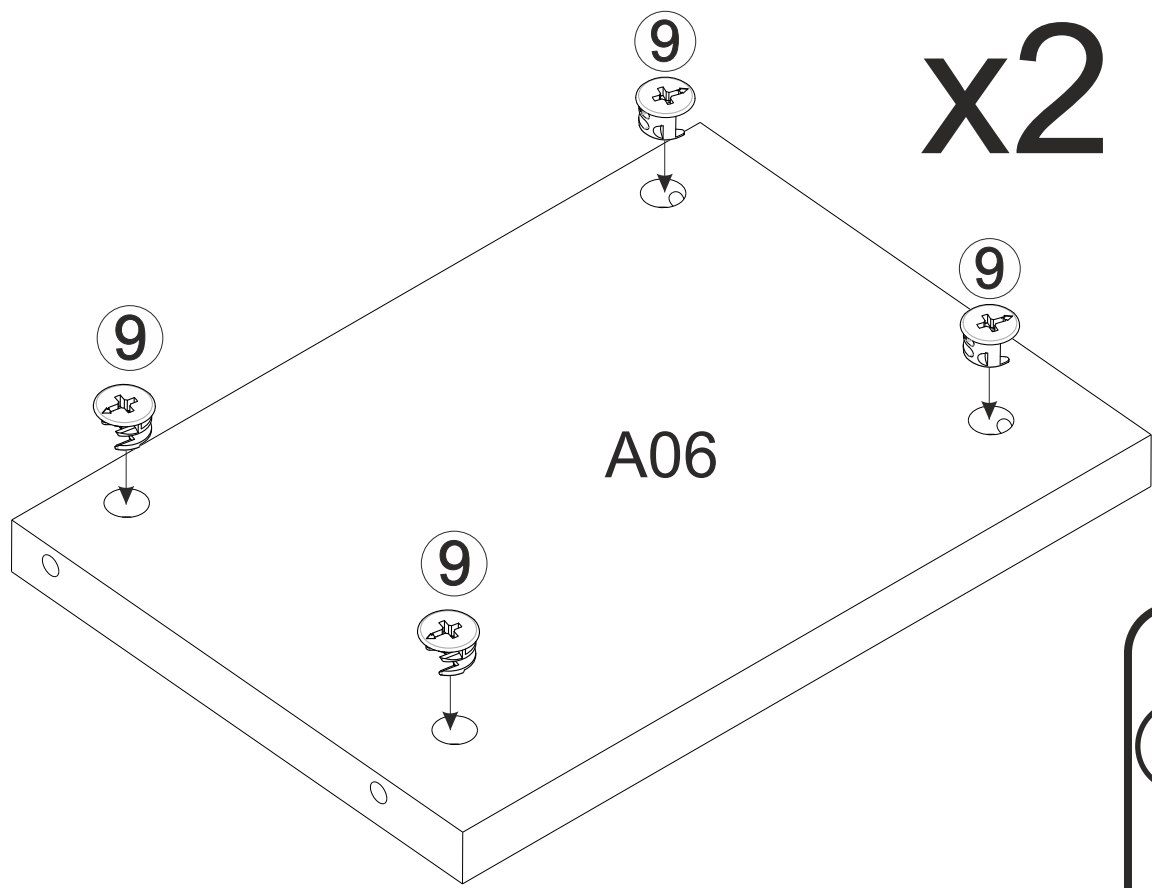
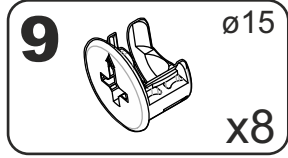

9

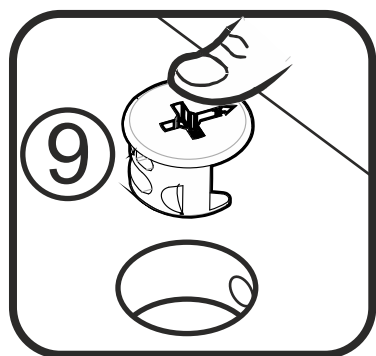
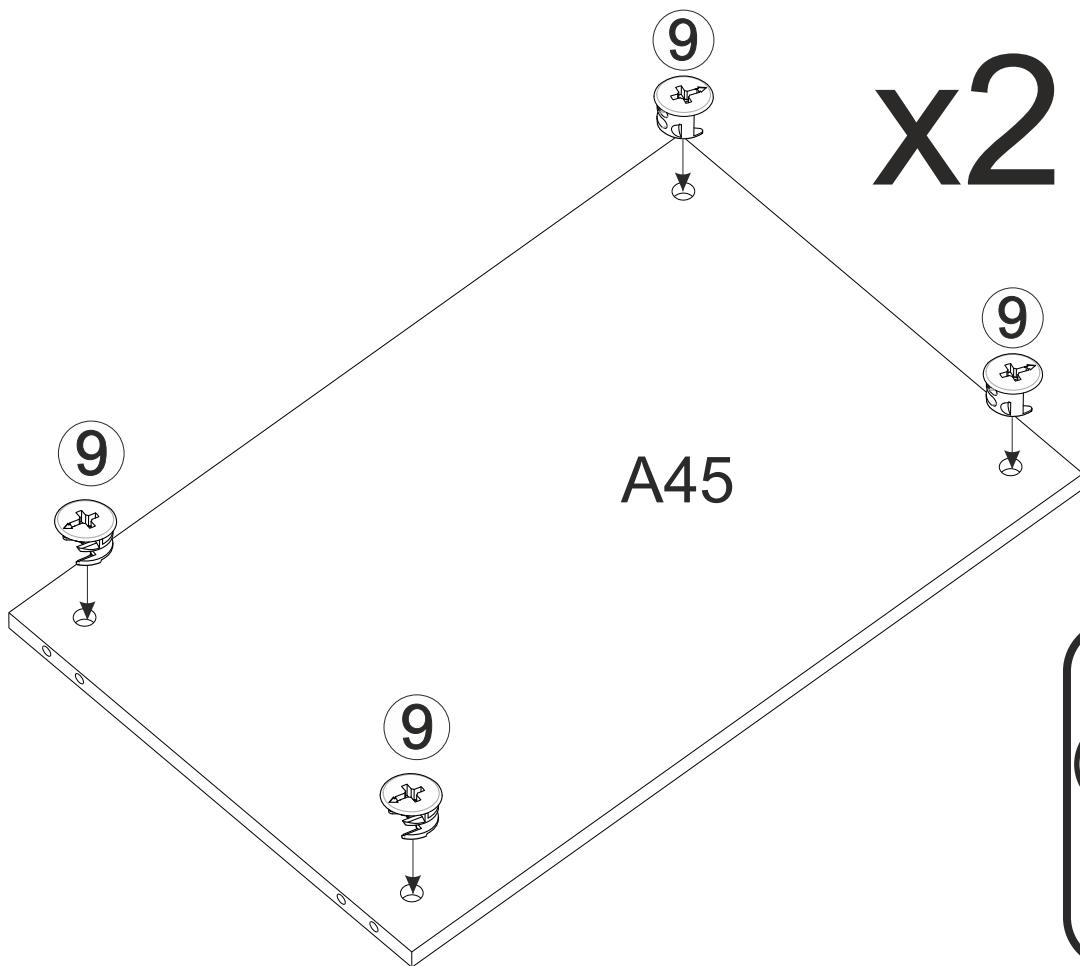
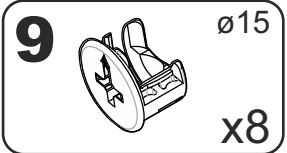

10

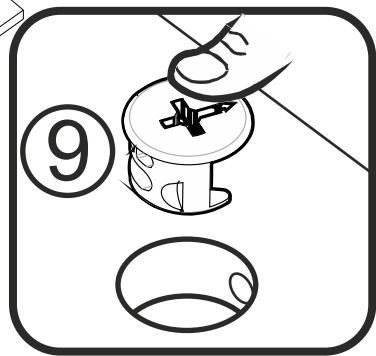
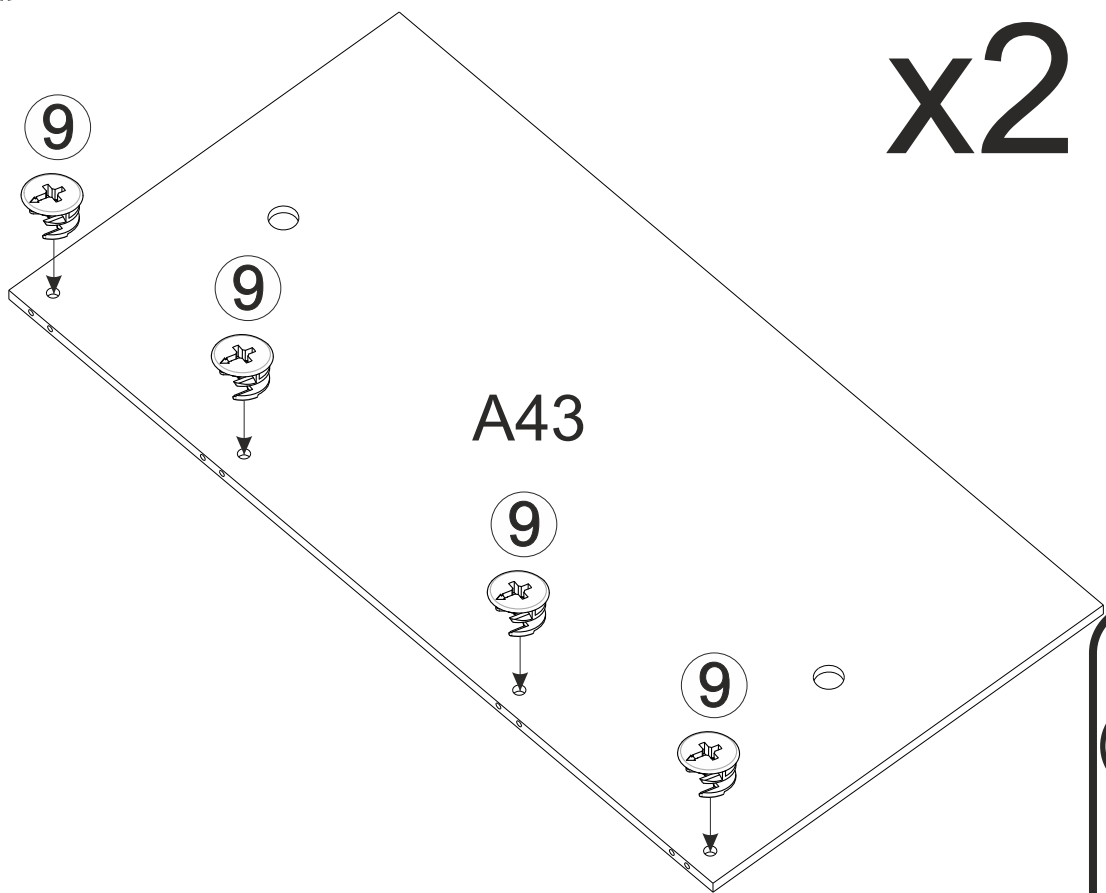
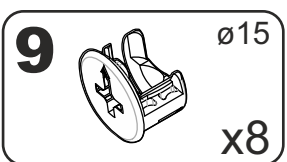

11

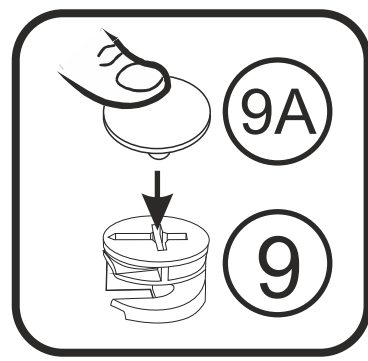
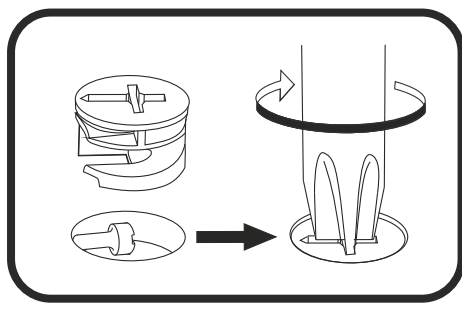
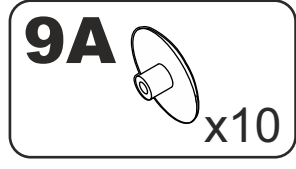
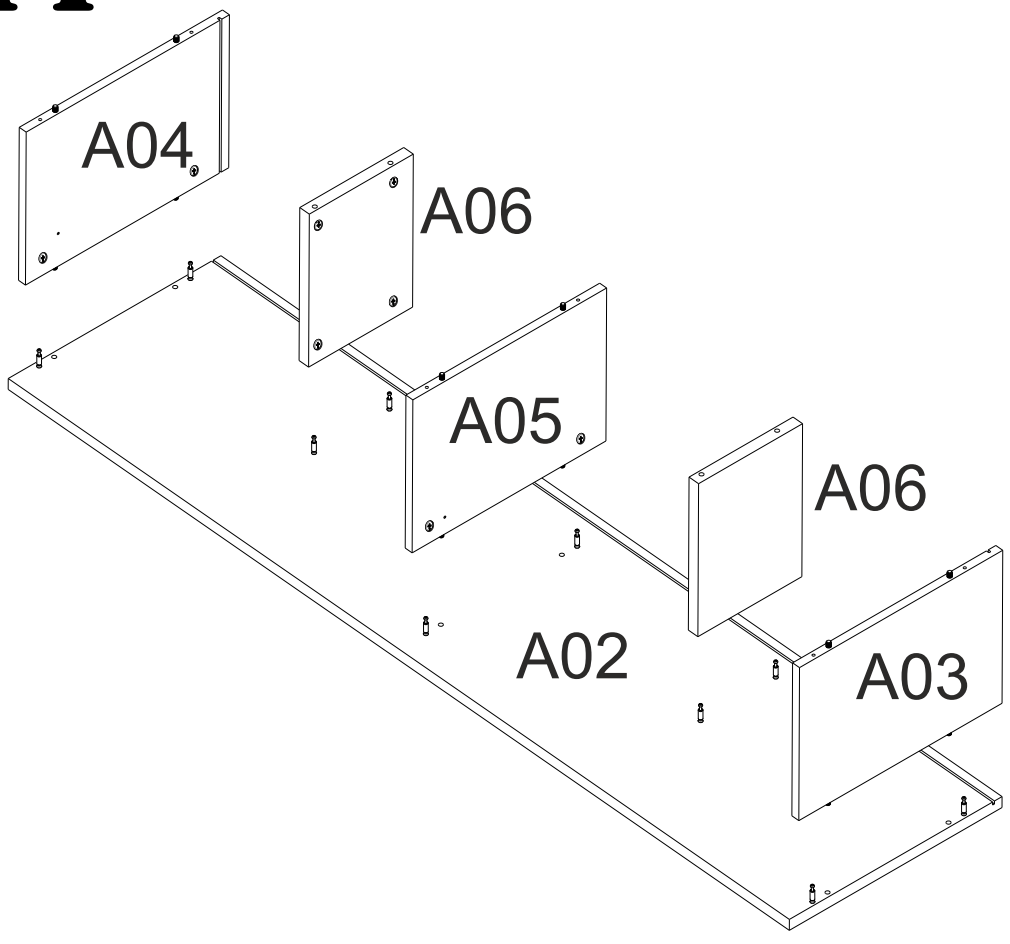

12

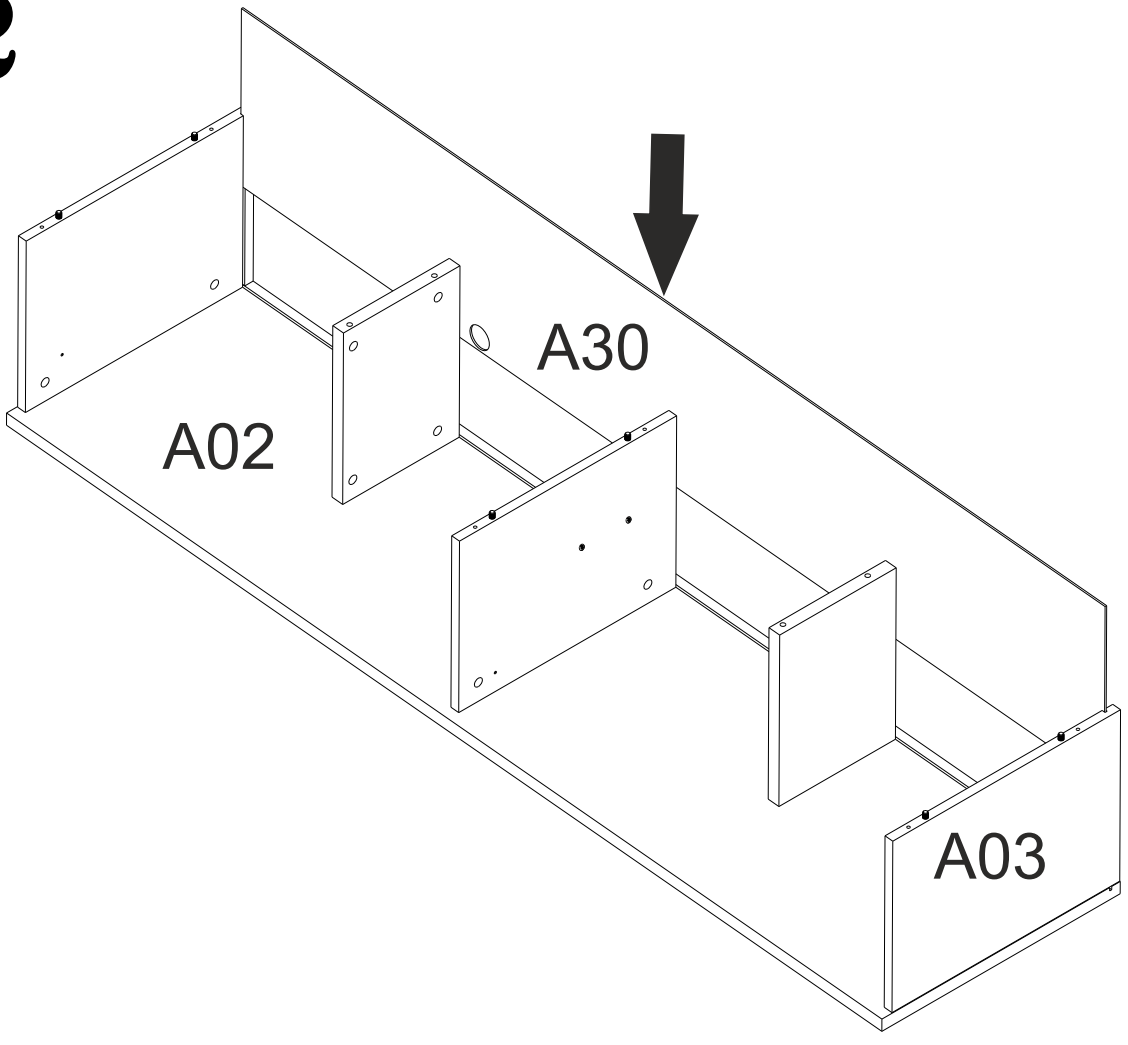

13

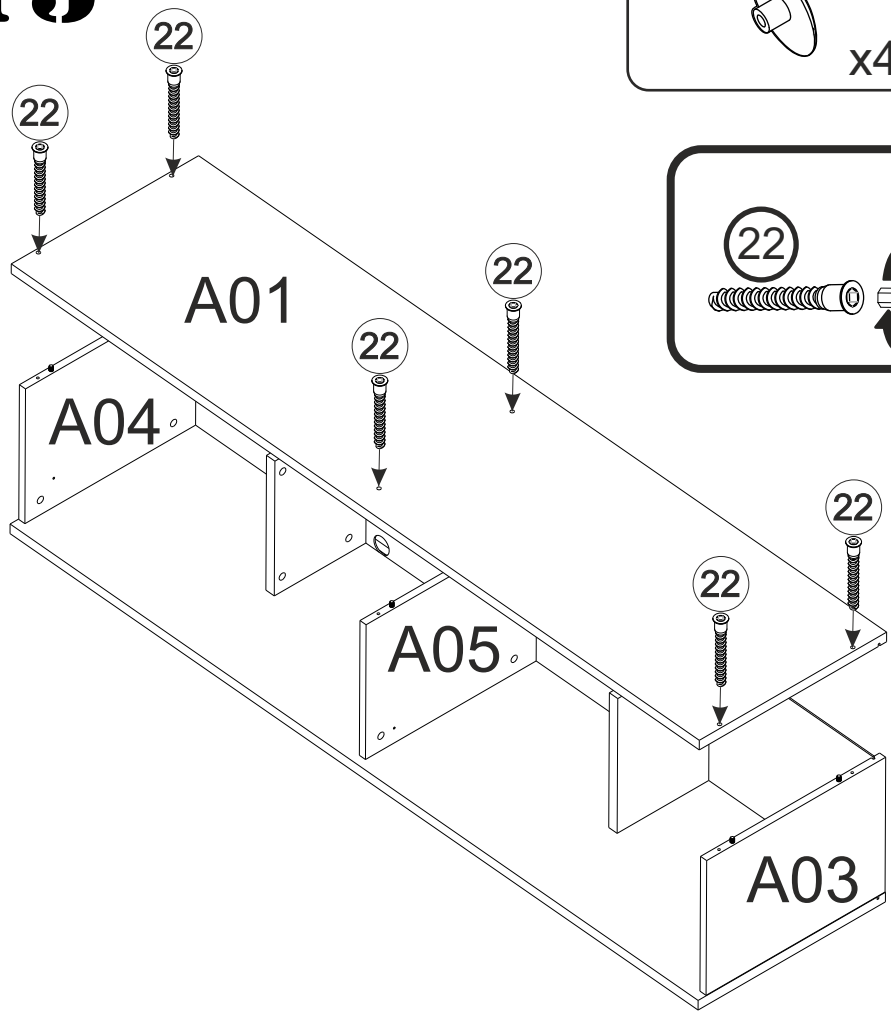

9A  x4

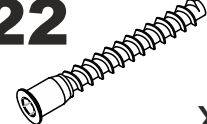
22  x6

22A  x6

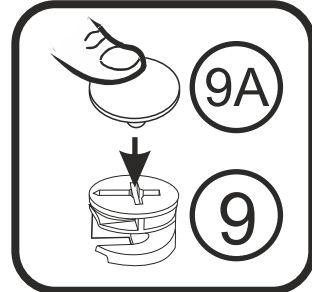
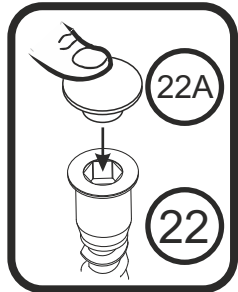
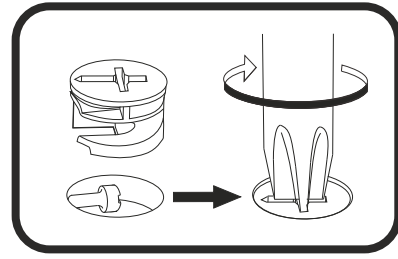
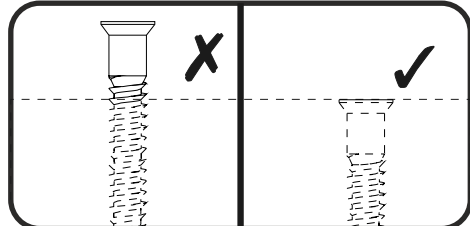
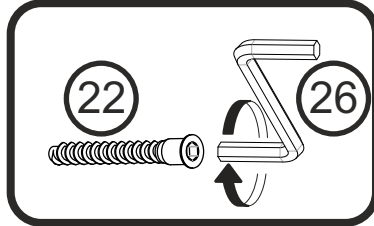

14

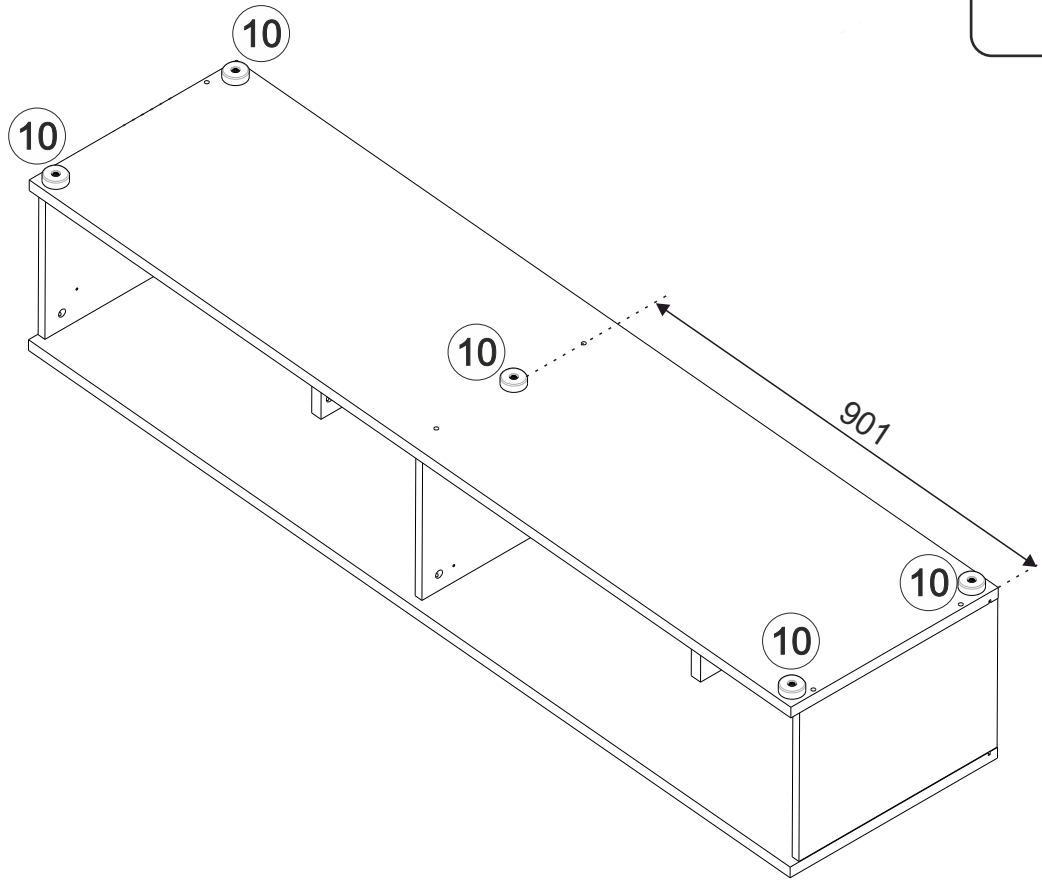

4A  4x16 x5

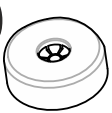
10  x5

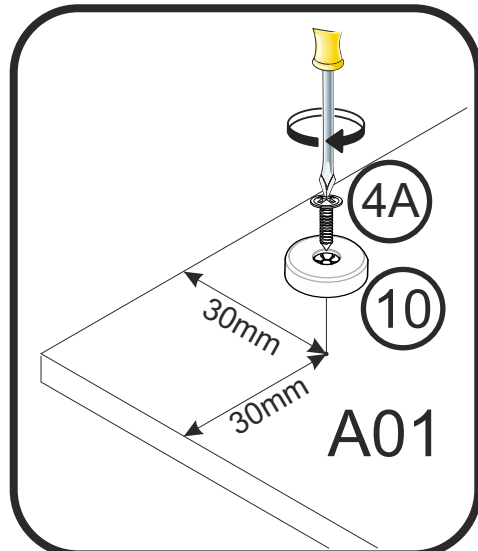

15

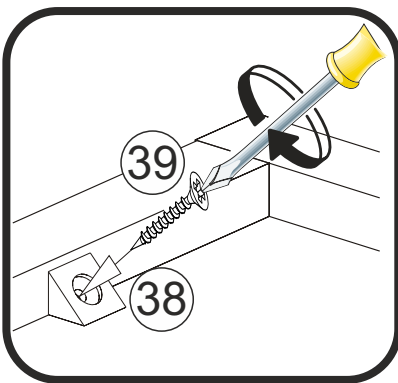
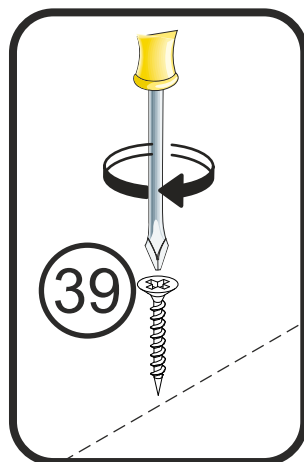
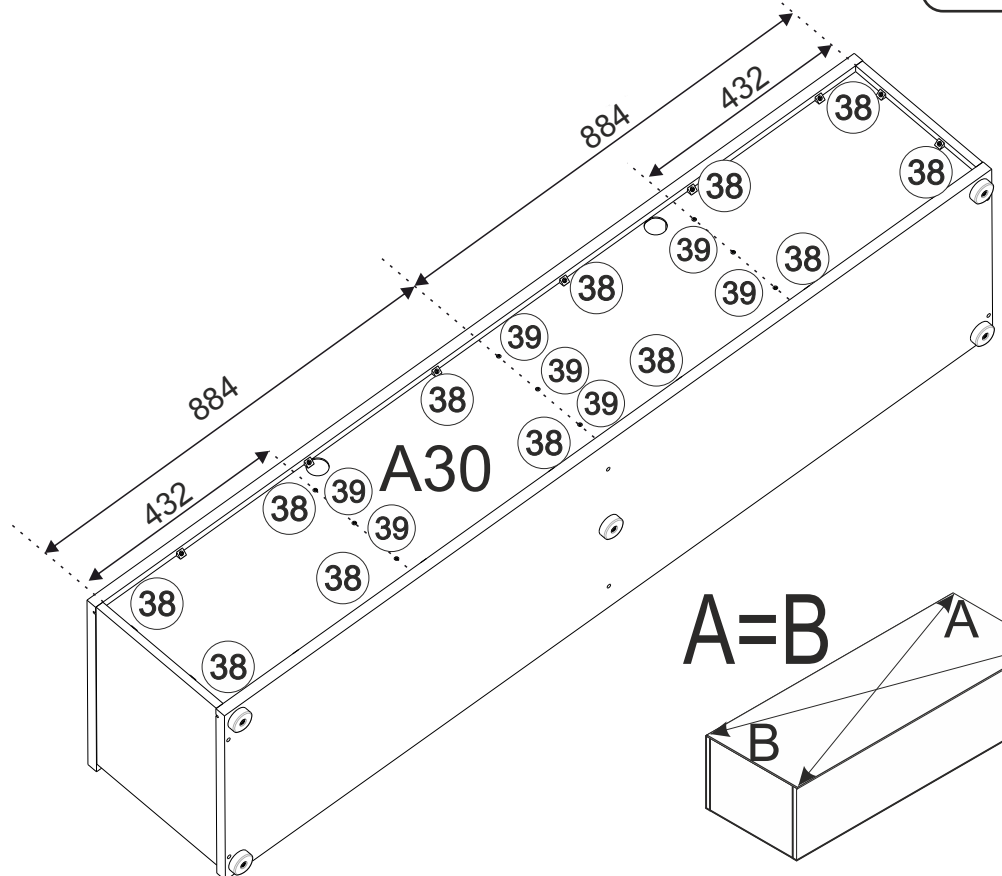
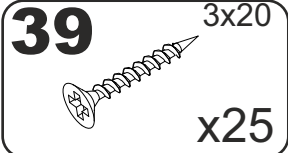
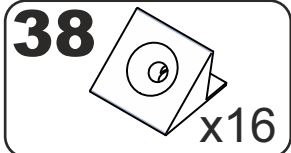

16

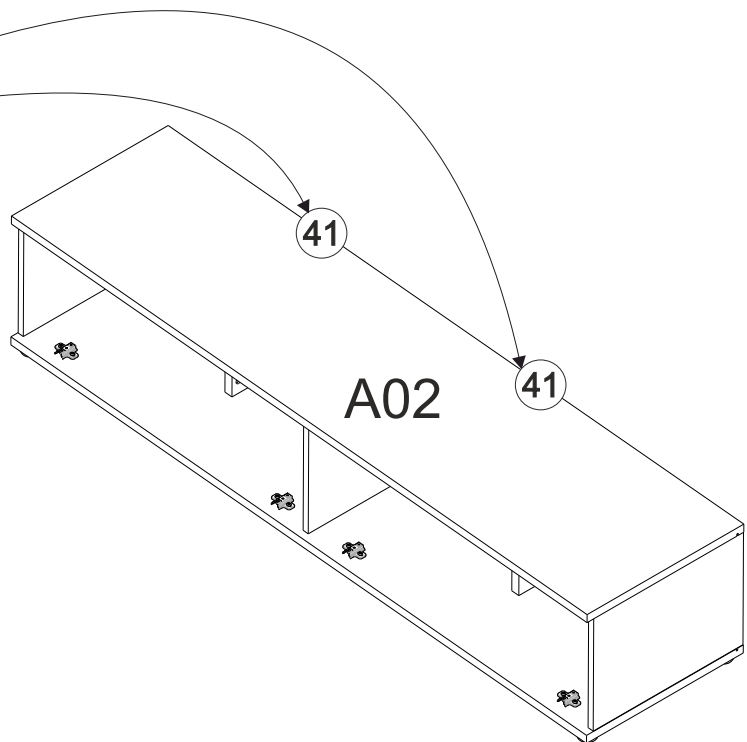
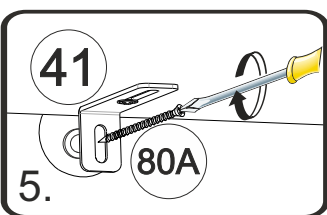
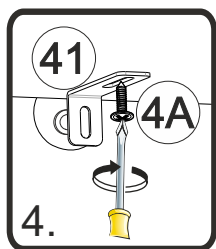
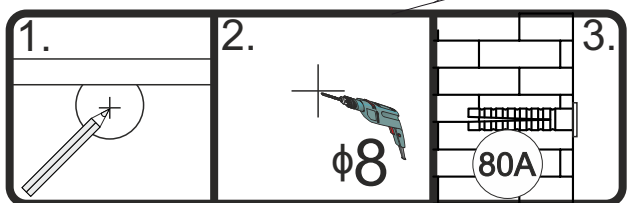
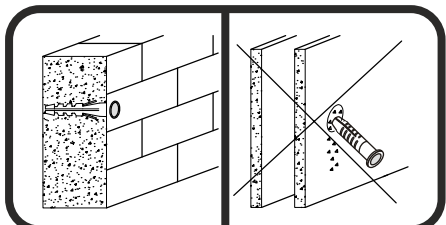
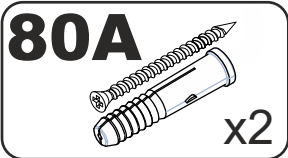
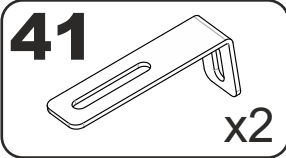
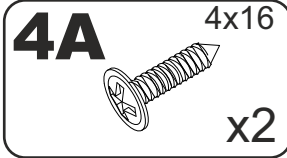

17

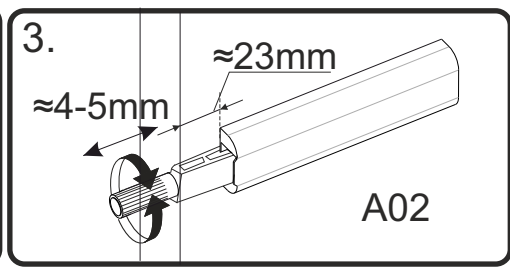
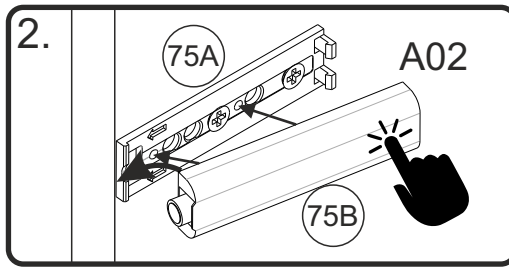
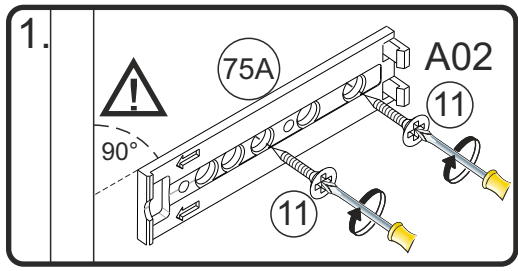
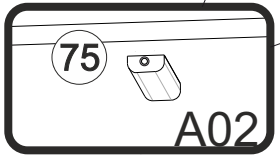
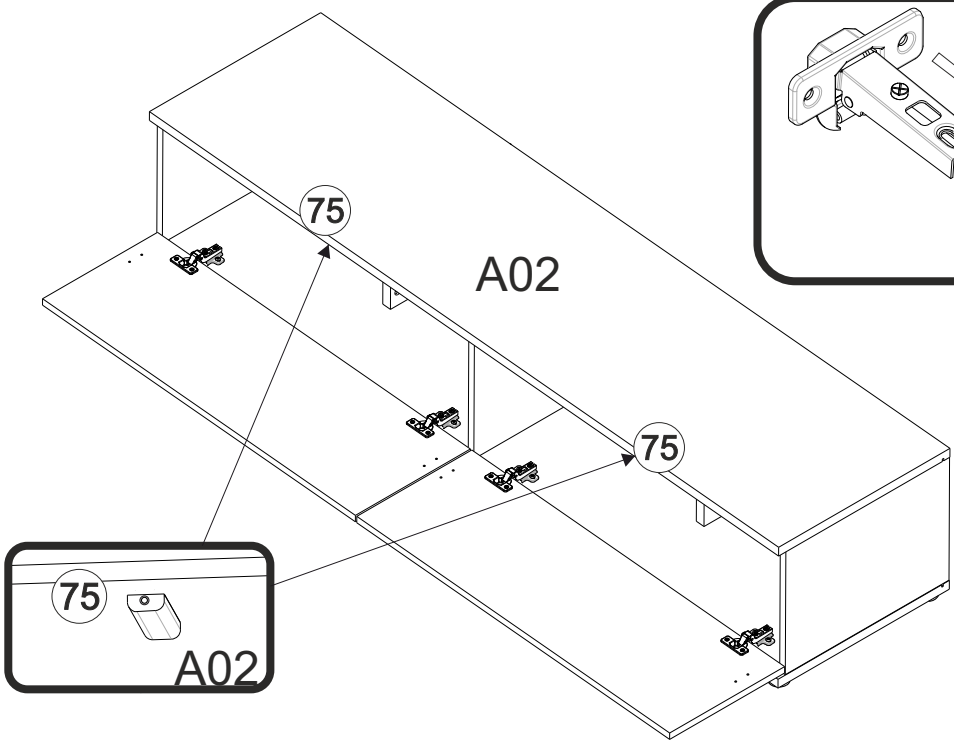
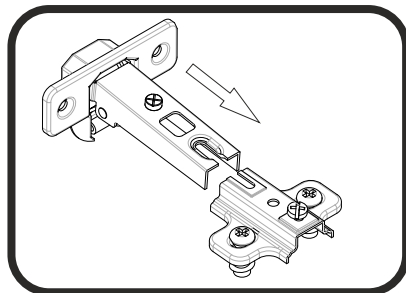
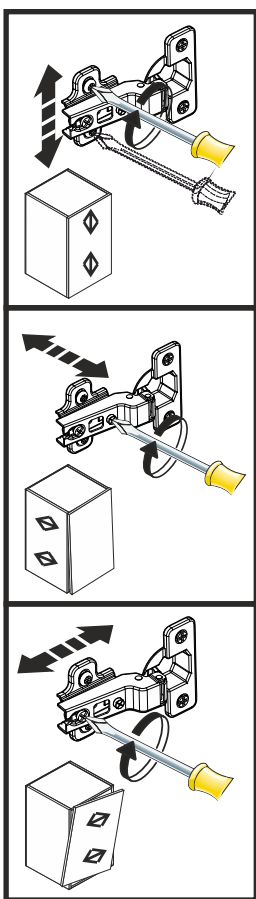
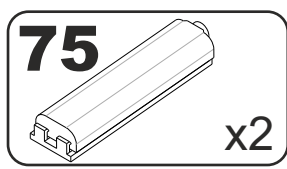
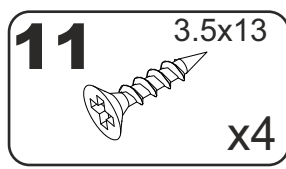

18

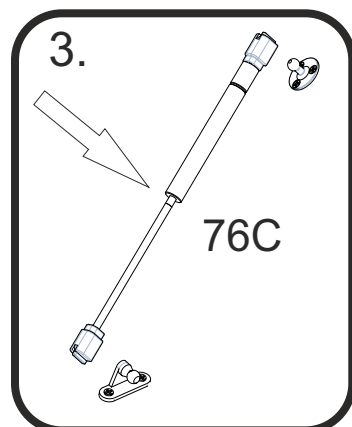
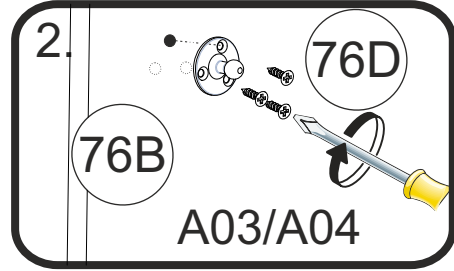
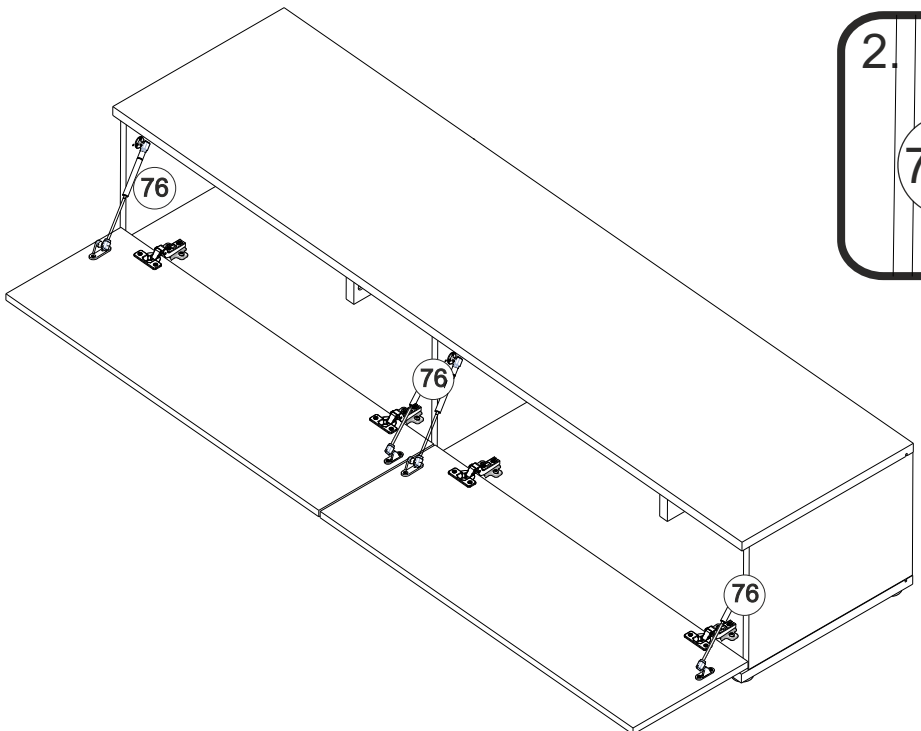
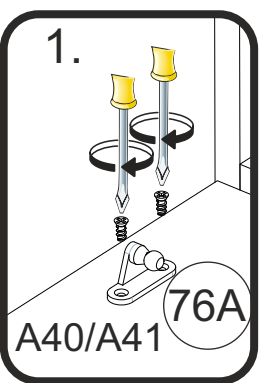
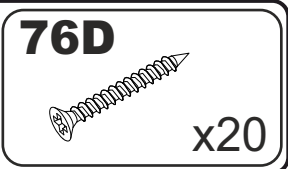
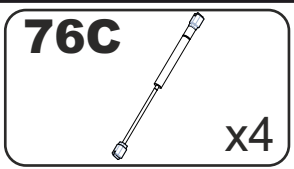
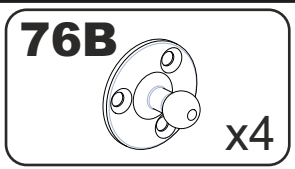
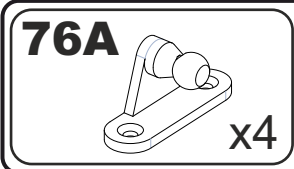

19

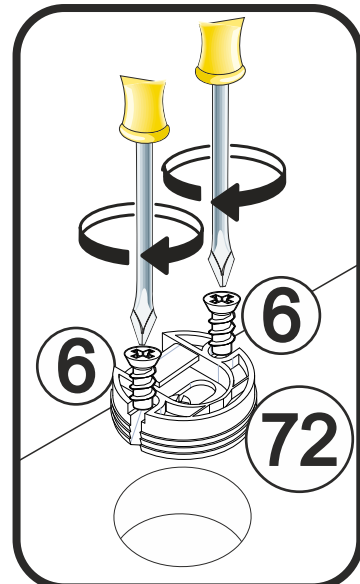
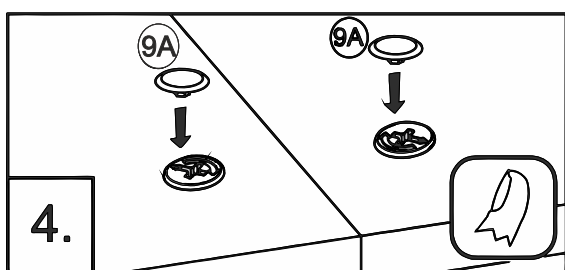
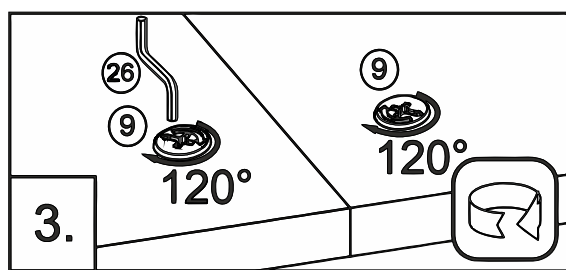
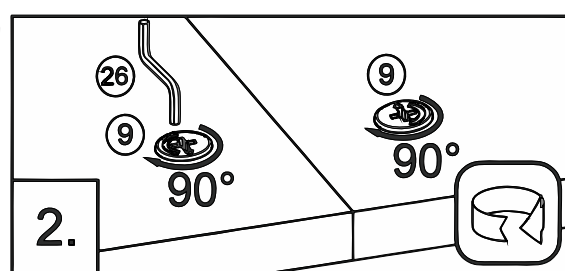
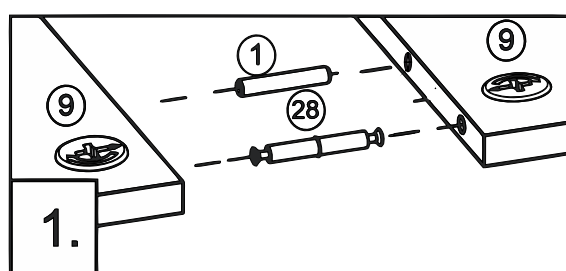
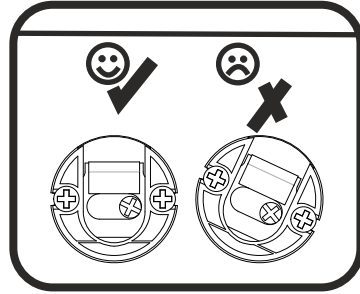
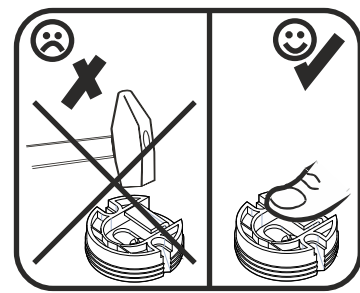
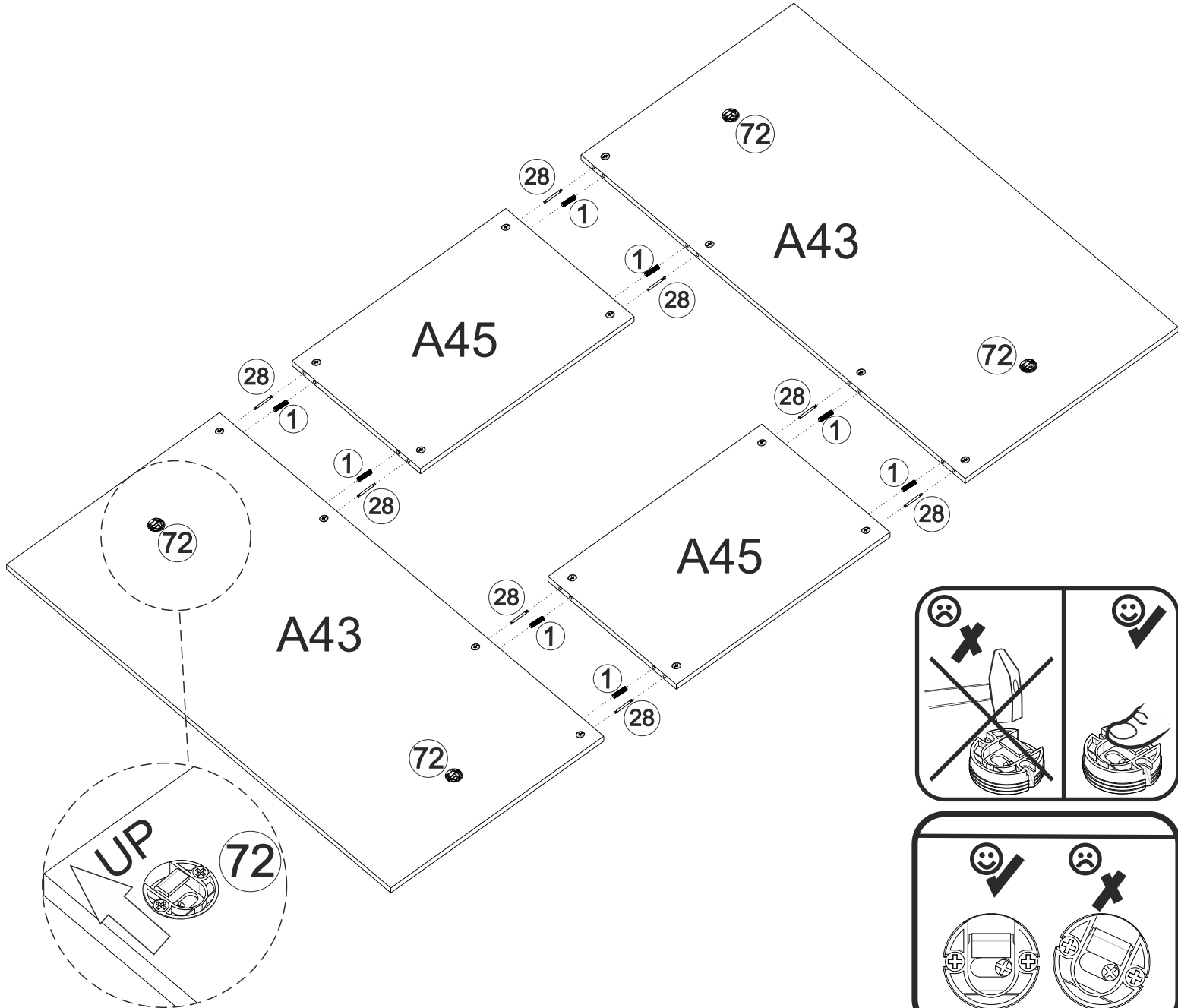
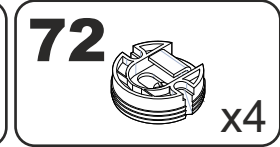
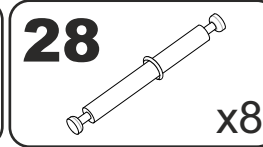
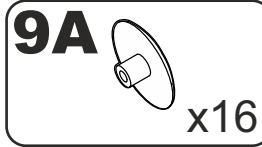
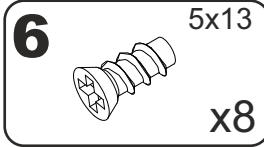
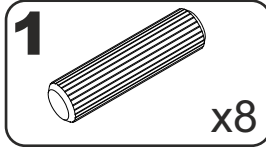

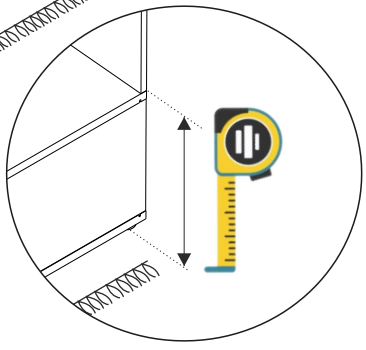
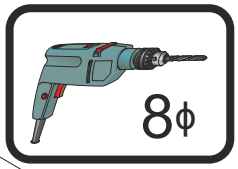
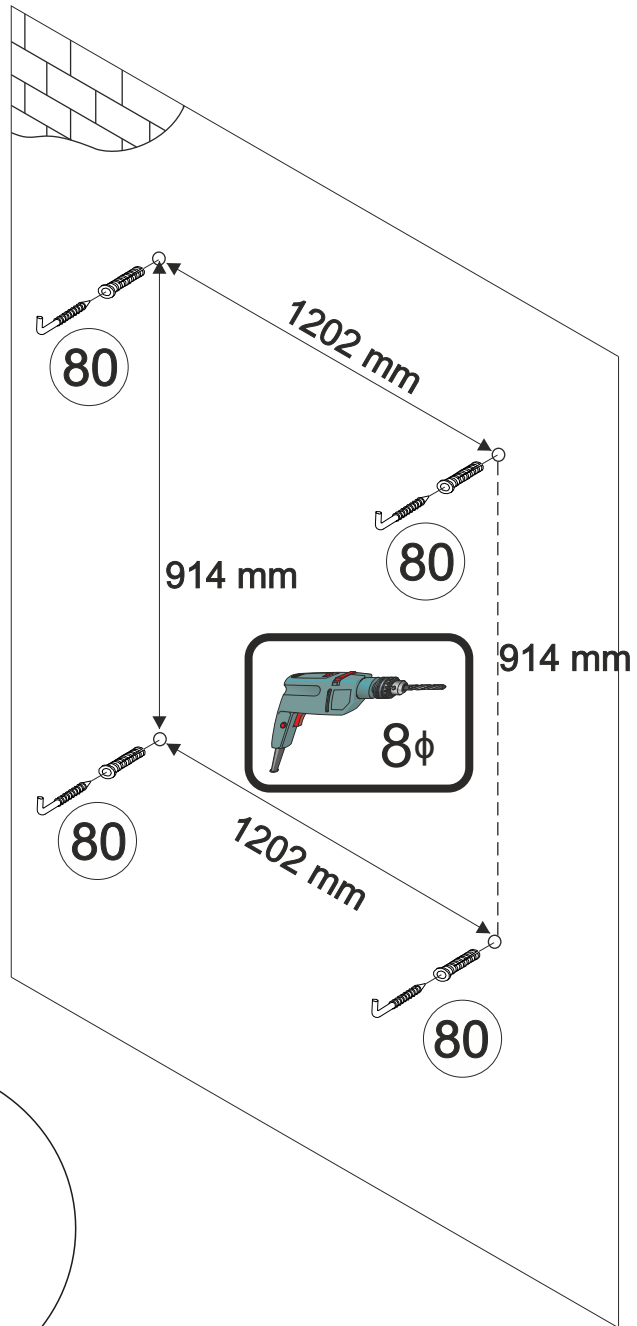
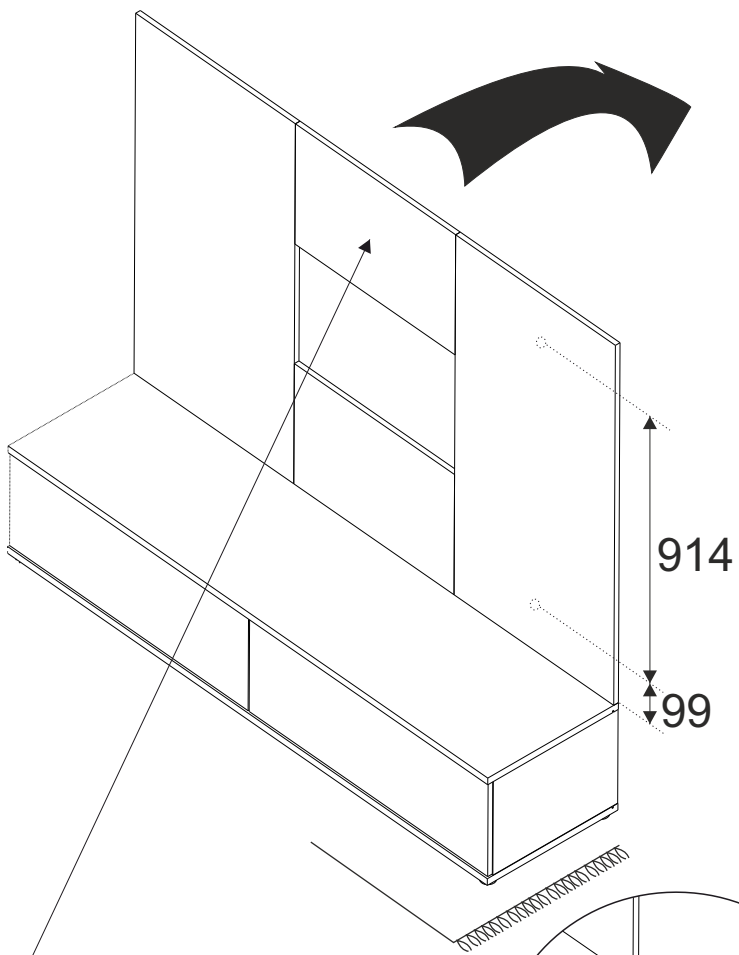
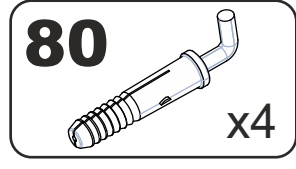

OPTION

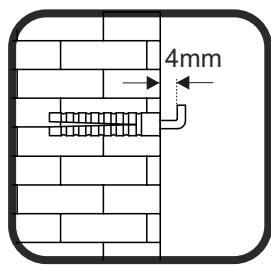
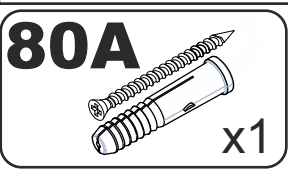
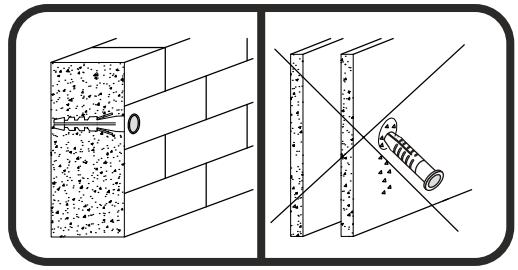
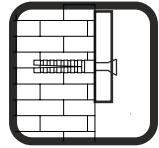
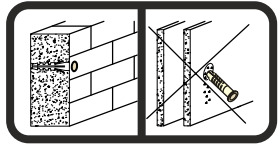
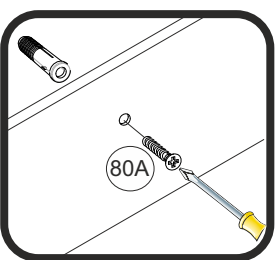
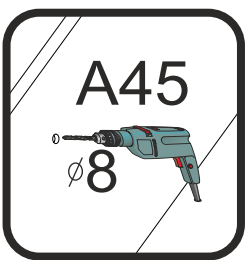

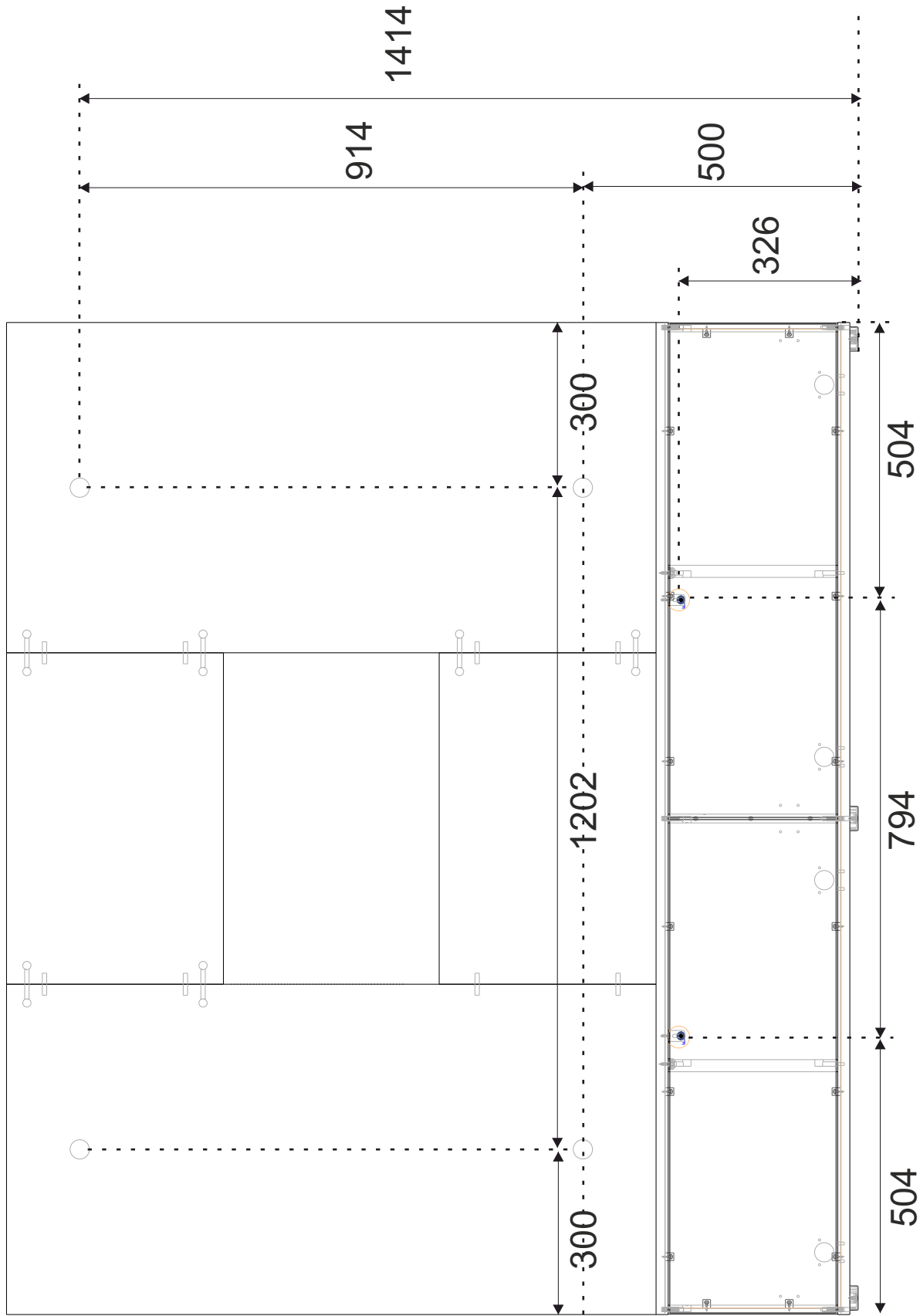
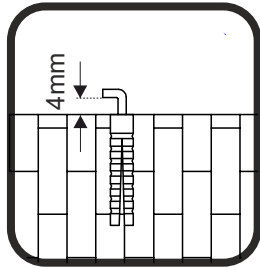
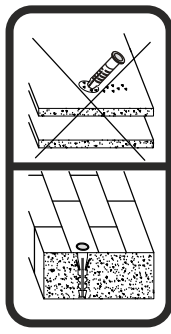
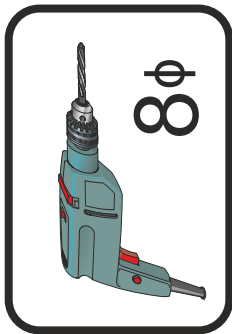

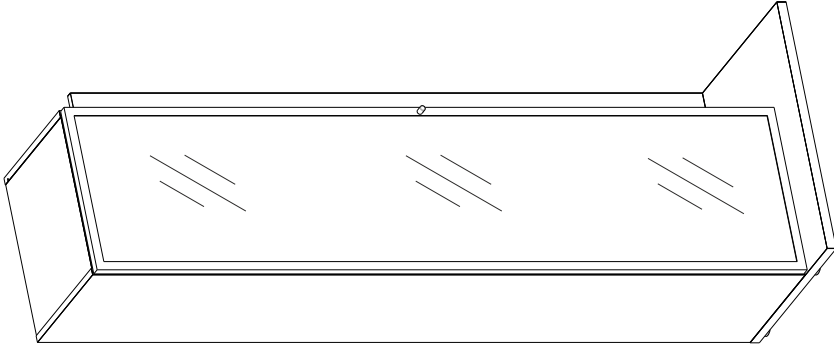

90 min

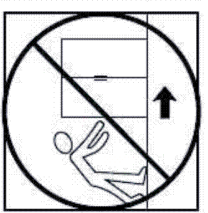
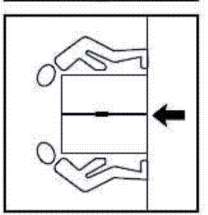
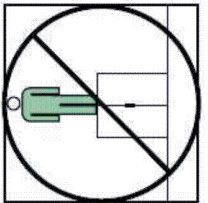
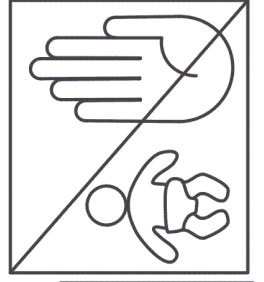
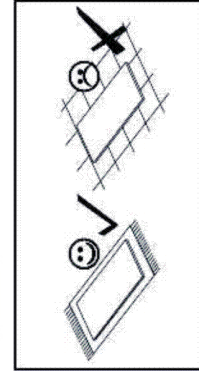
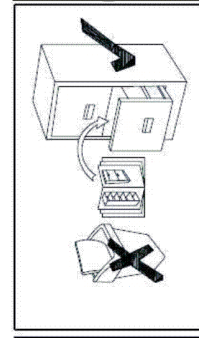
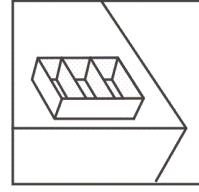
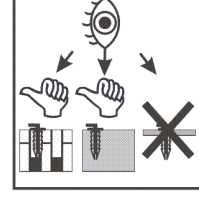
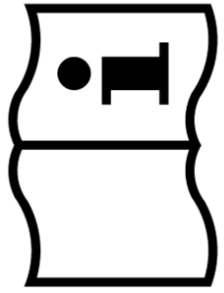
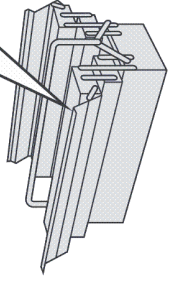
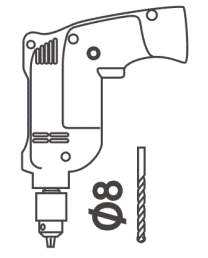
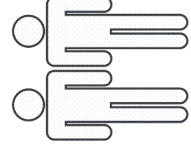
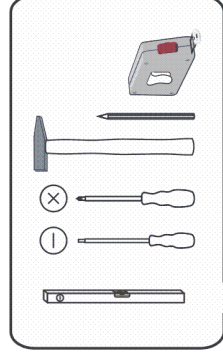

FR Pensez à donner ou recycler. Association ou Magasin ou Déchèterie

<https://quefairedemesdechets.fr>

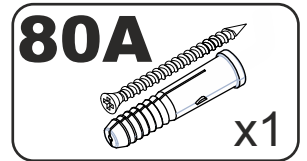
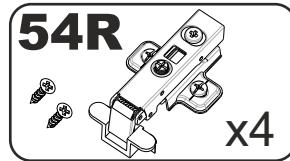
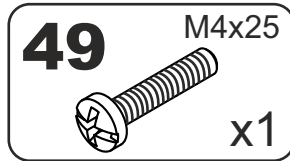
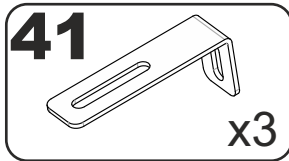
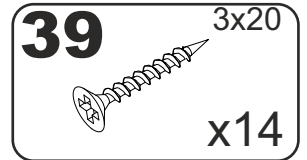
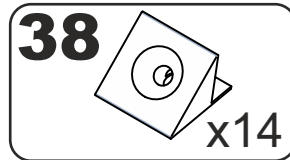
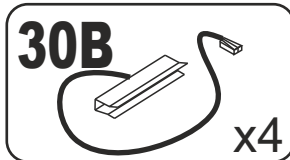
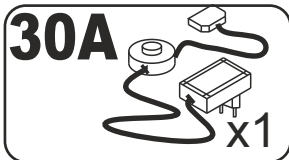
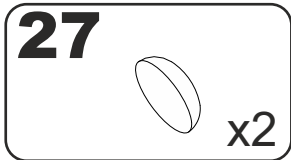
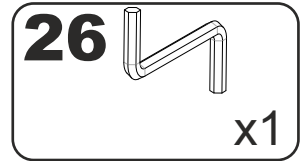
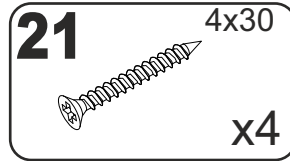
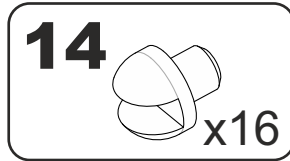
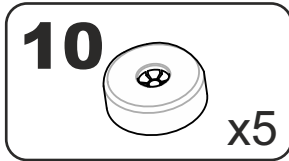
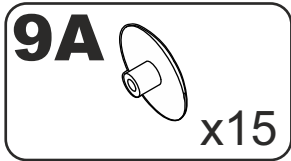
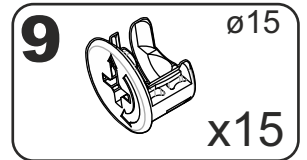
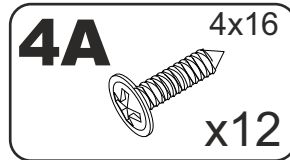
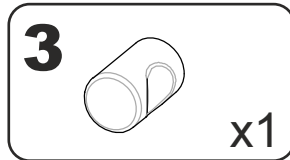
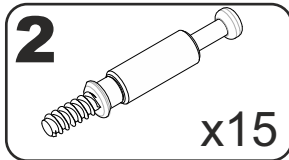
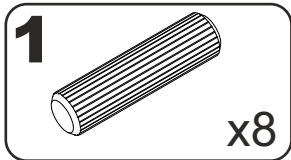
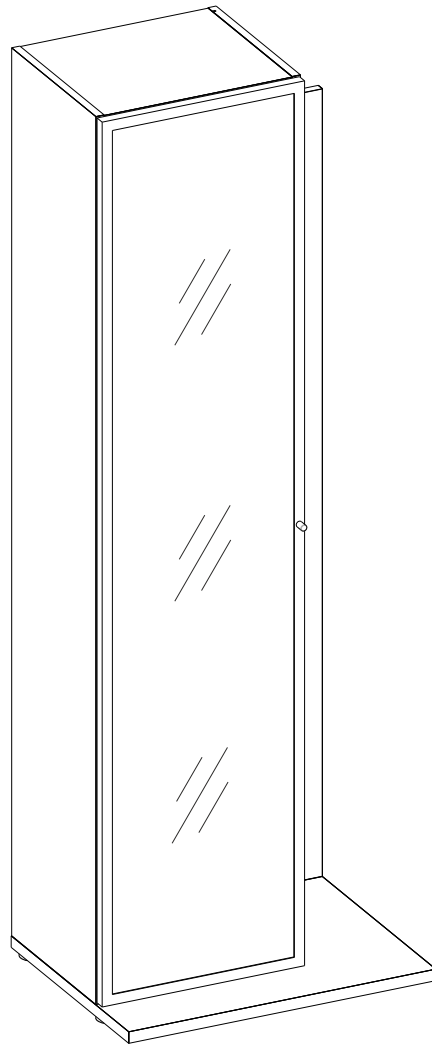
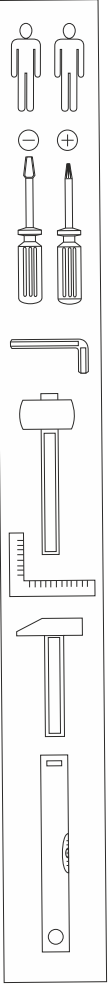

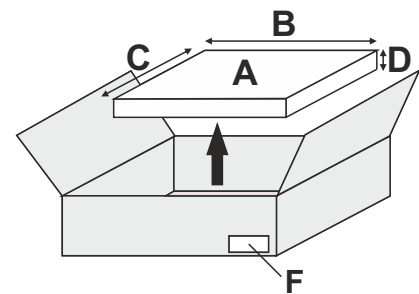
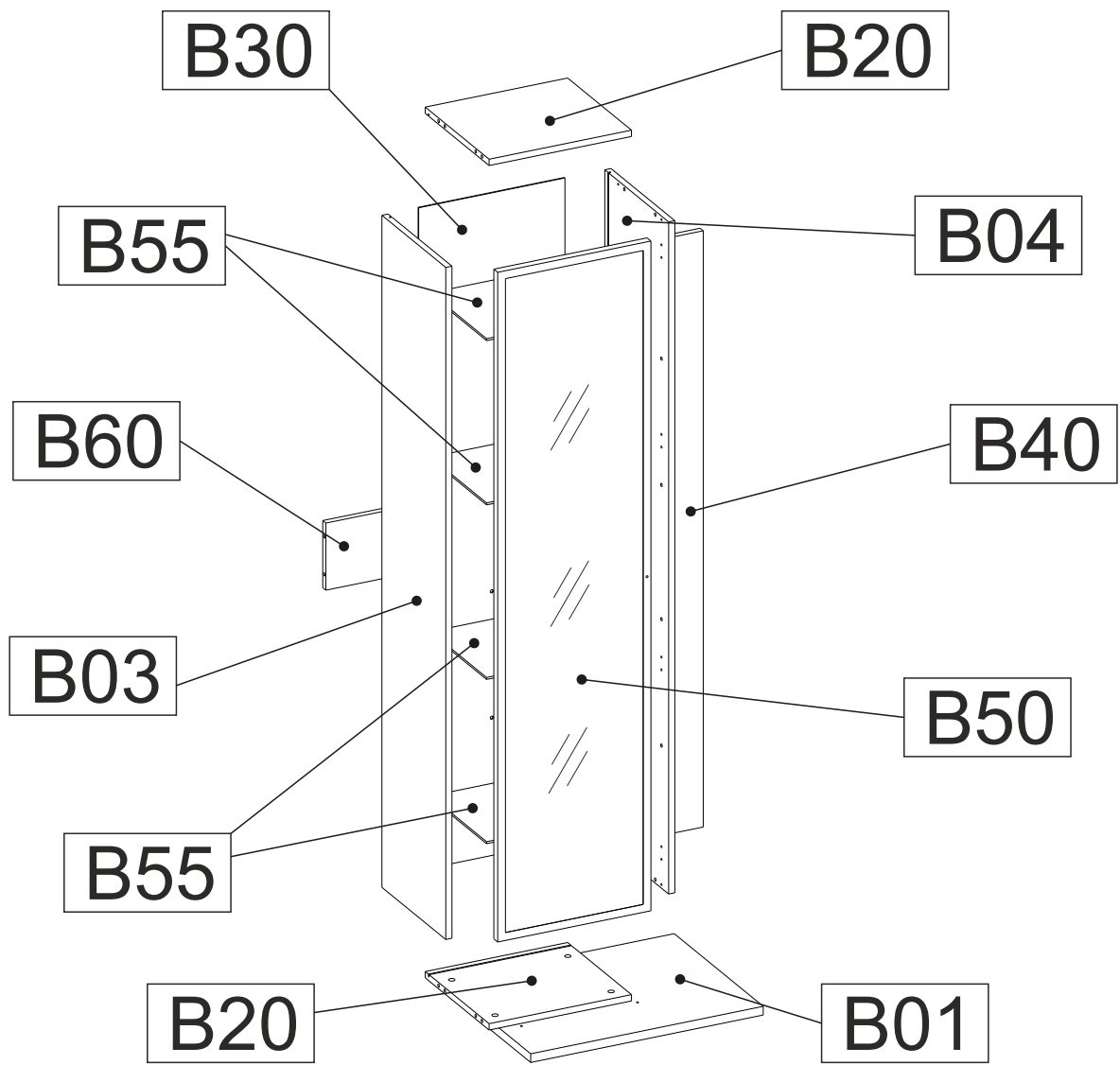

A	B_(mm)	C_(mm)	D_(mm)	E	F
B01	601	460	22	1	1 2
B03	1702	330	16	1	2 2
B04	1702	330	16	1	2 2
B20	368	330	16	2	1 2
B30	1678	378	3	1	2 2
B40	1510	200	16	1	2 2
B50	1696	396	20	1	2 2
B55	361	290	5	4	1 2
B60	368	170	16	1	1 2

VERSION 1

PAGE :9-14

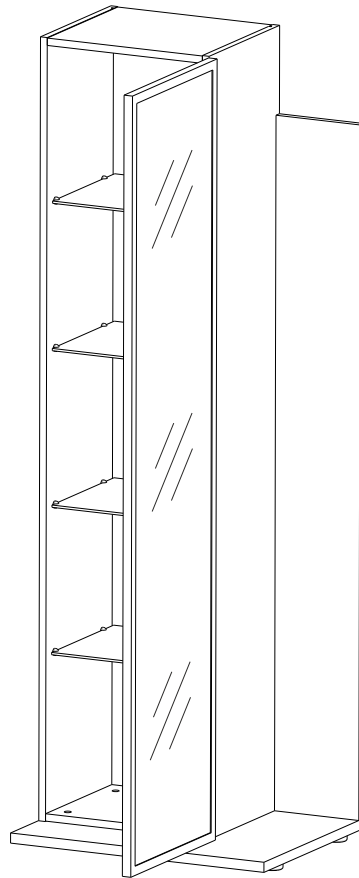
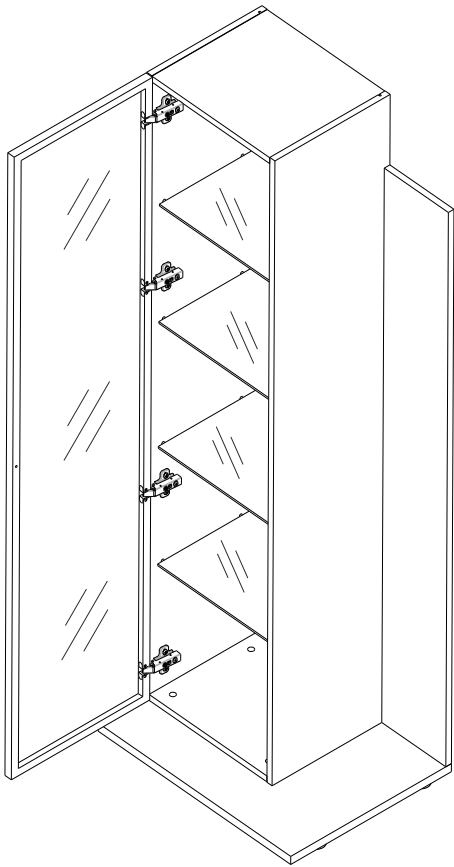

VERSION 2

PAGE :14-19

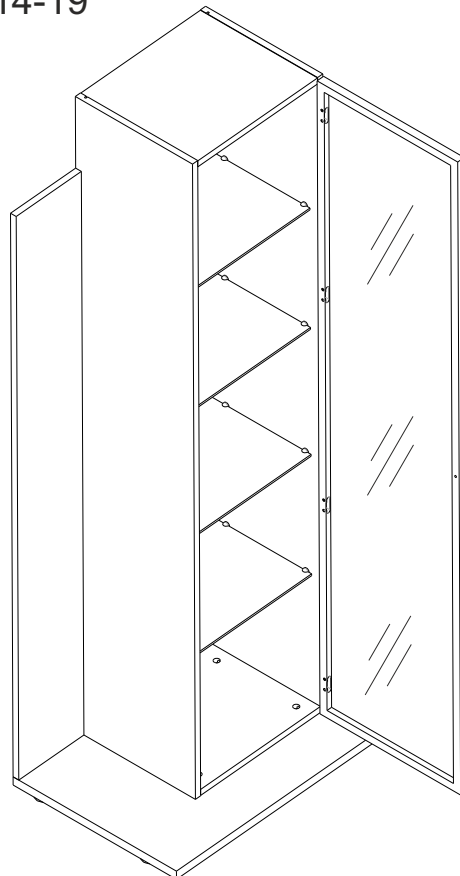
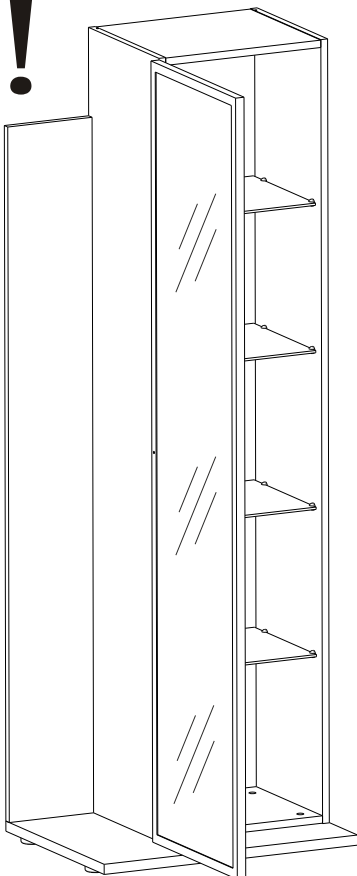

1

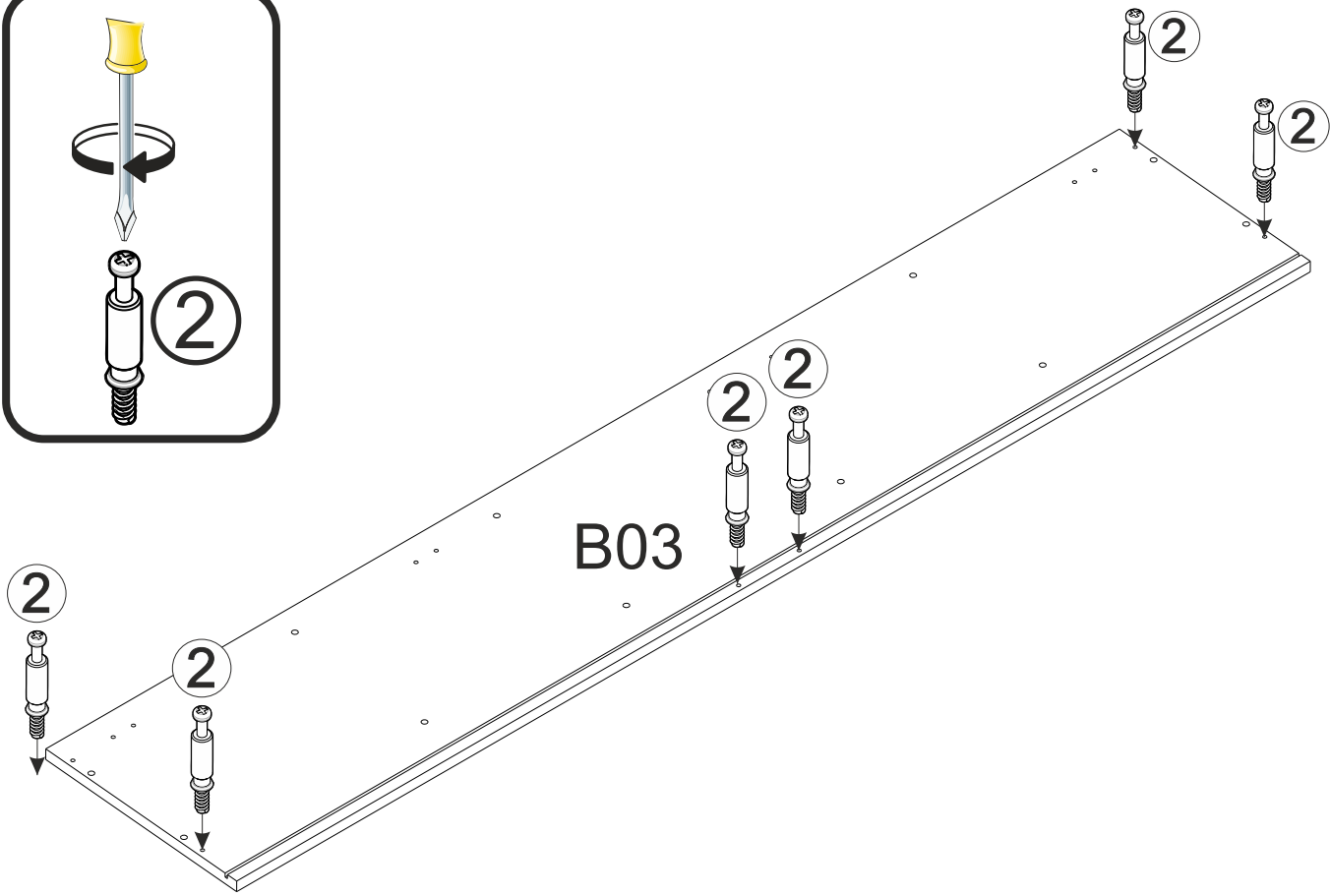
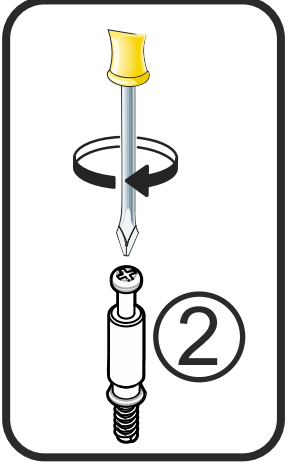
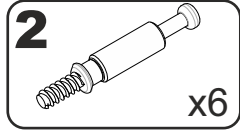

2

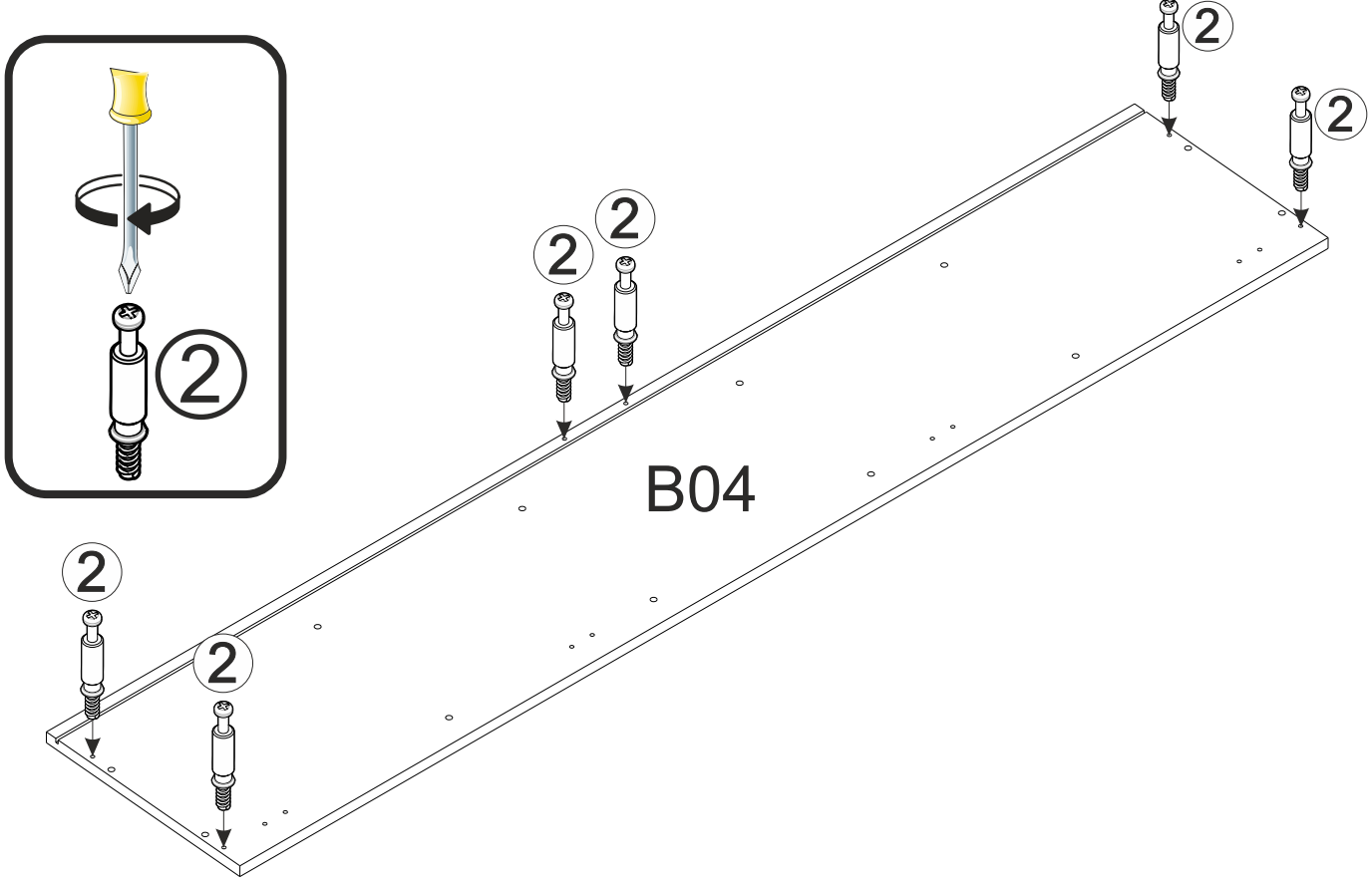
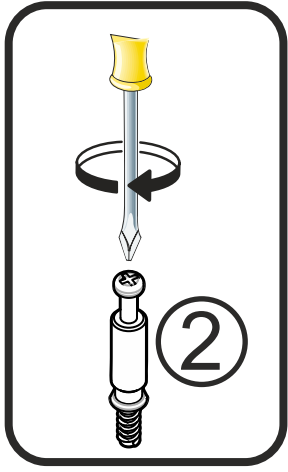
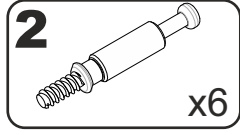

3

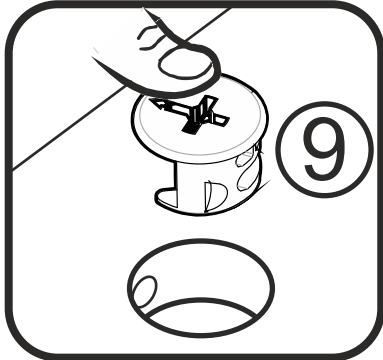
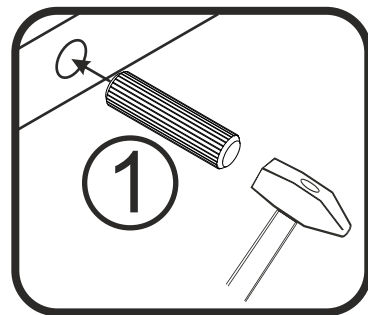
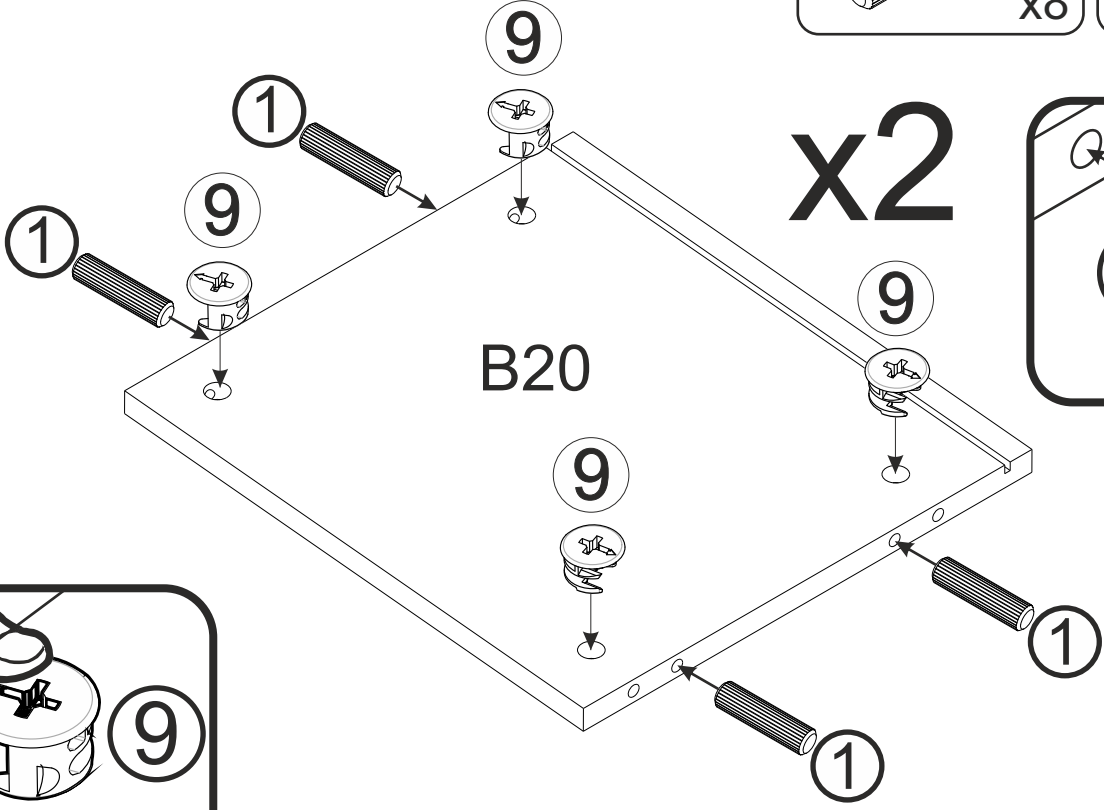
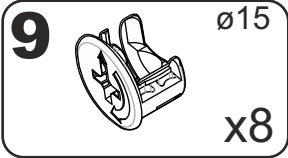
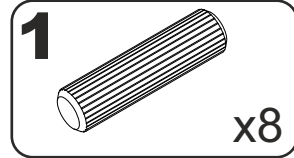

4

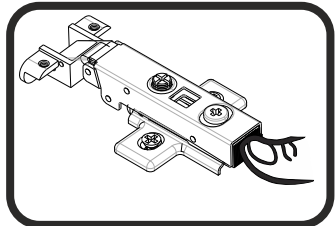
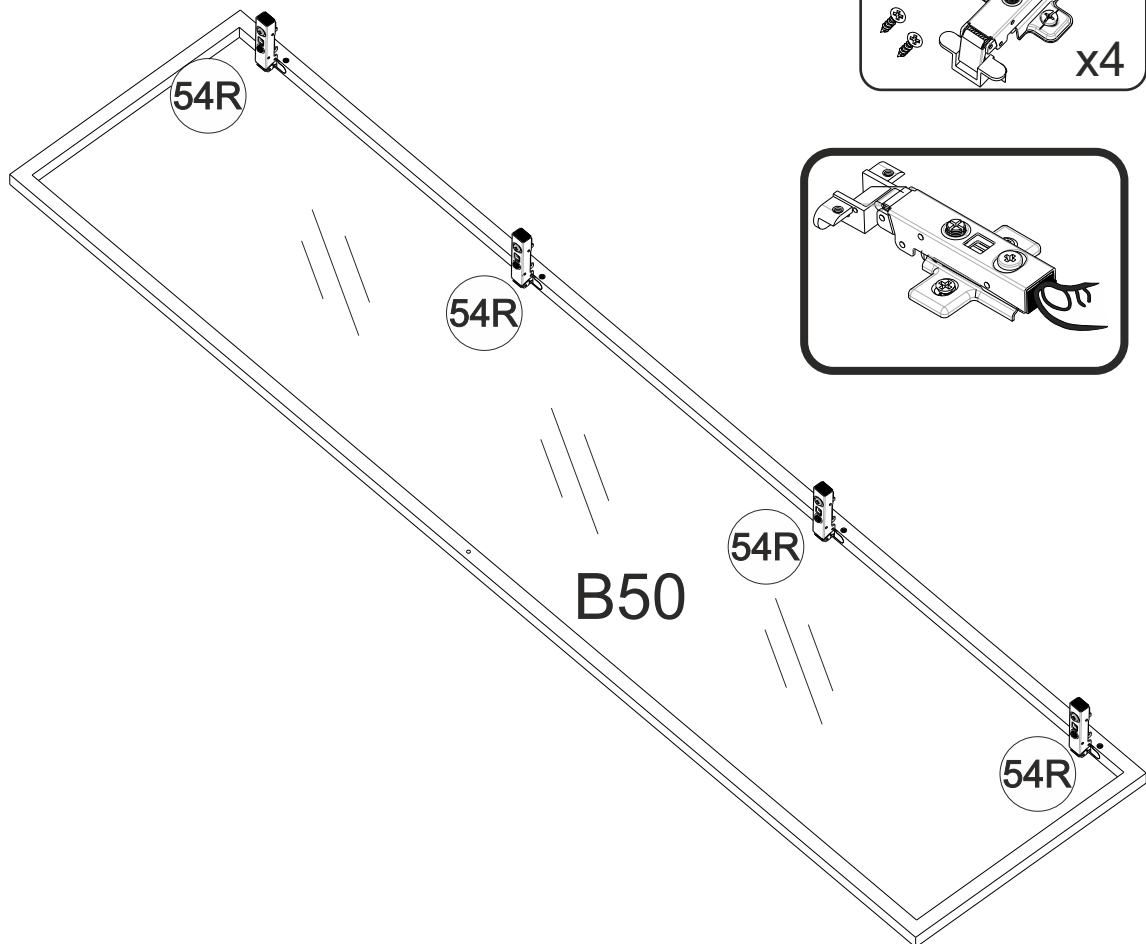
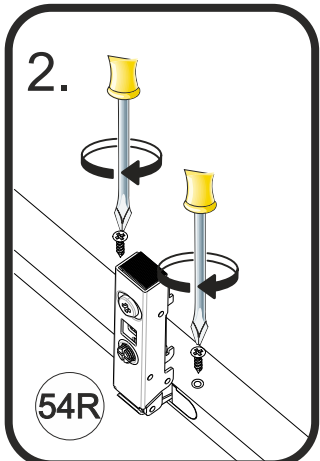
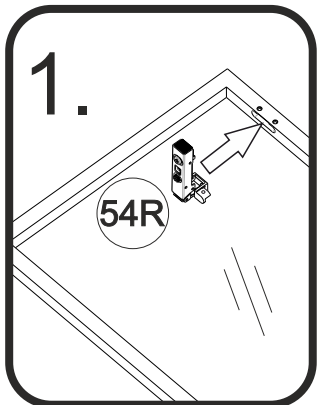
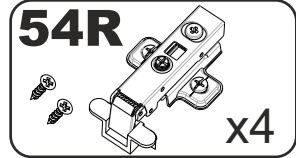

5

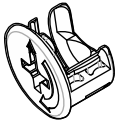
9  ø15
x4

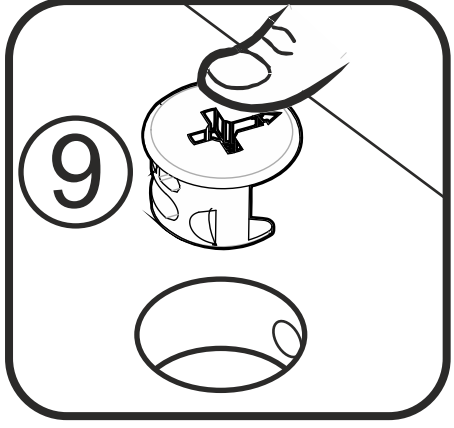
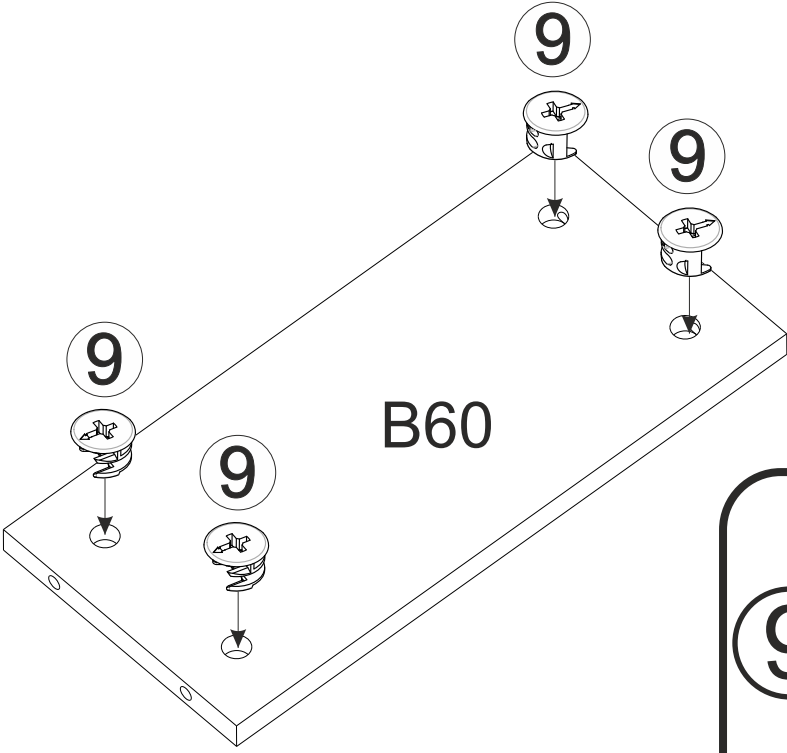

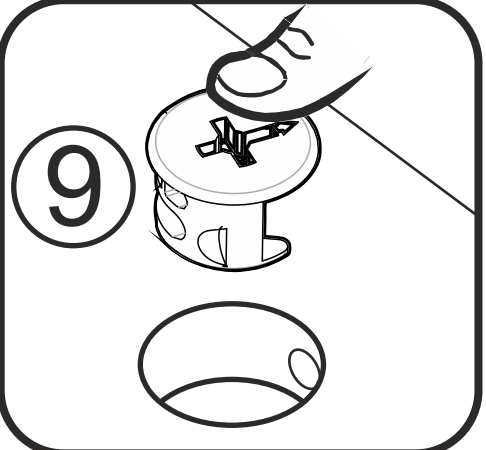
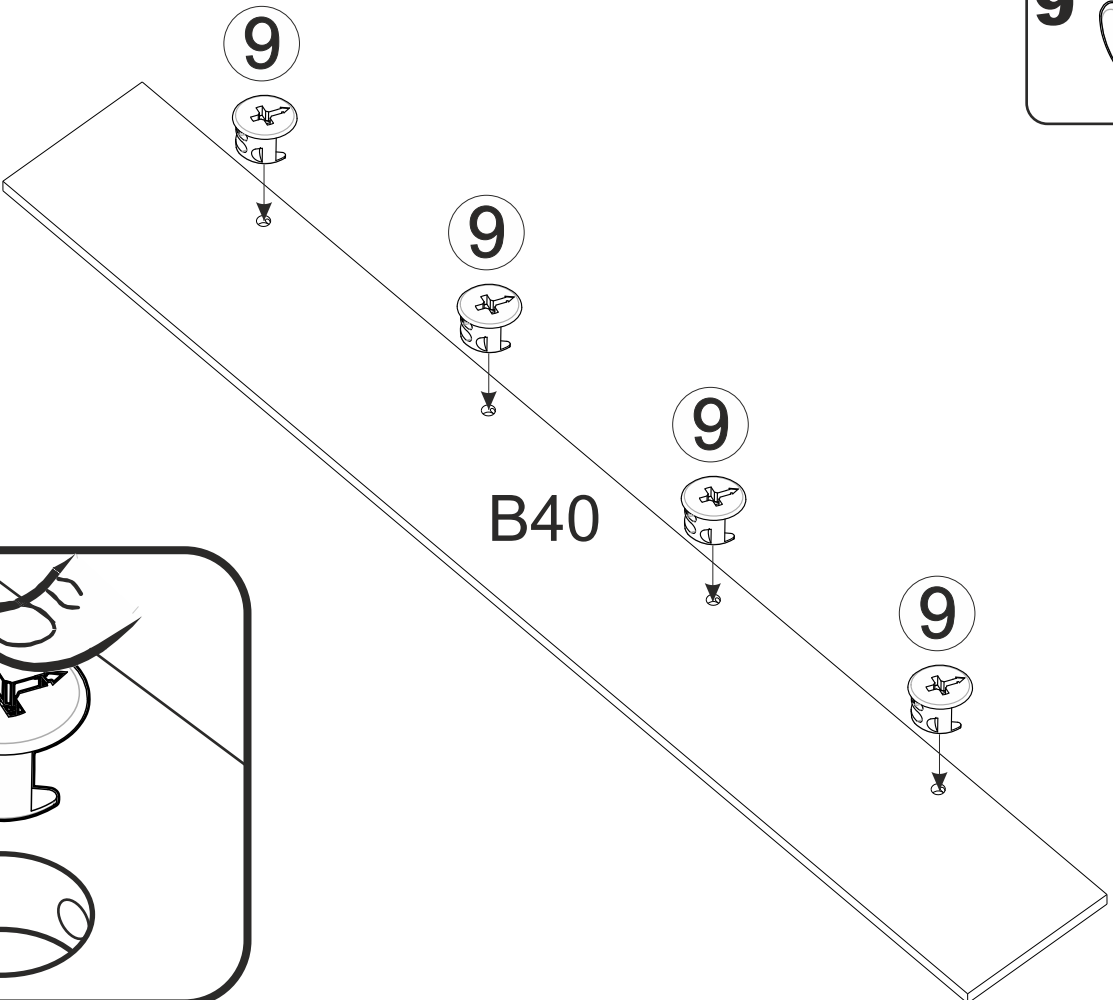

6

9  ø15
x4

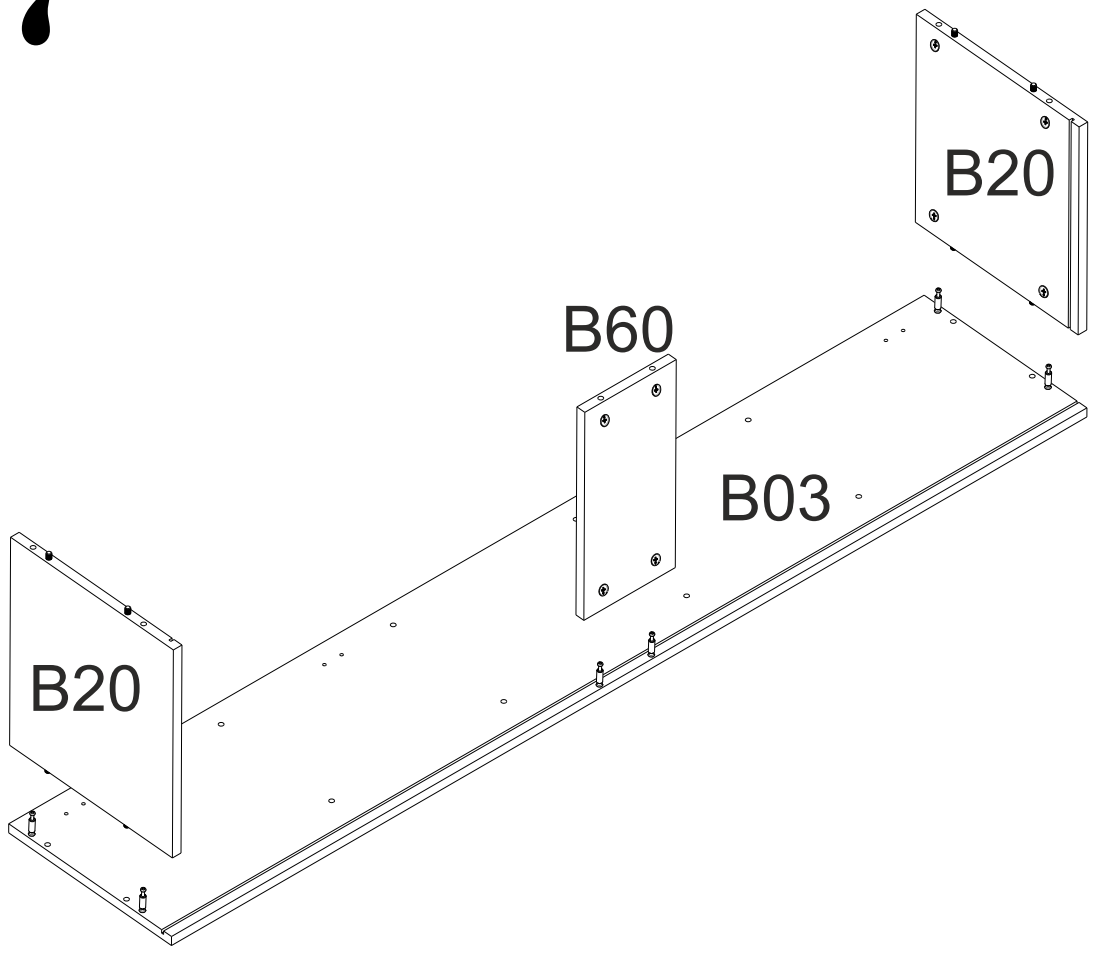

7



9A  x6

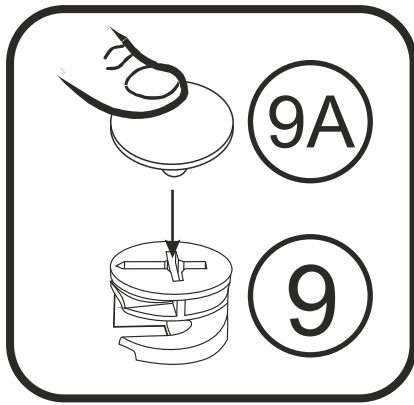
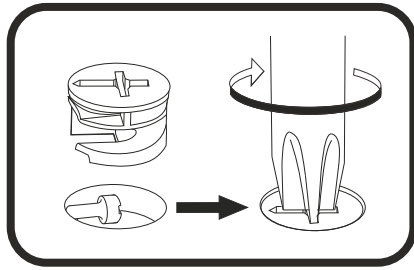

8

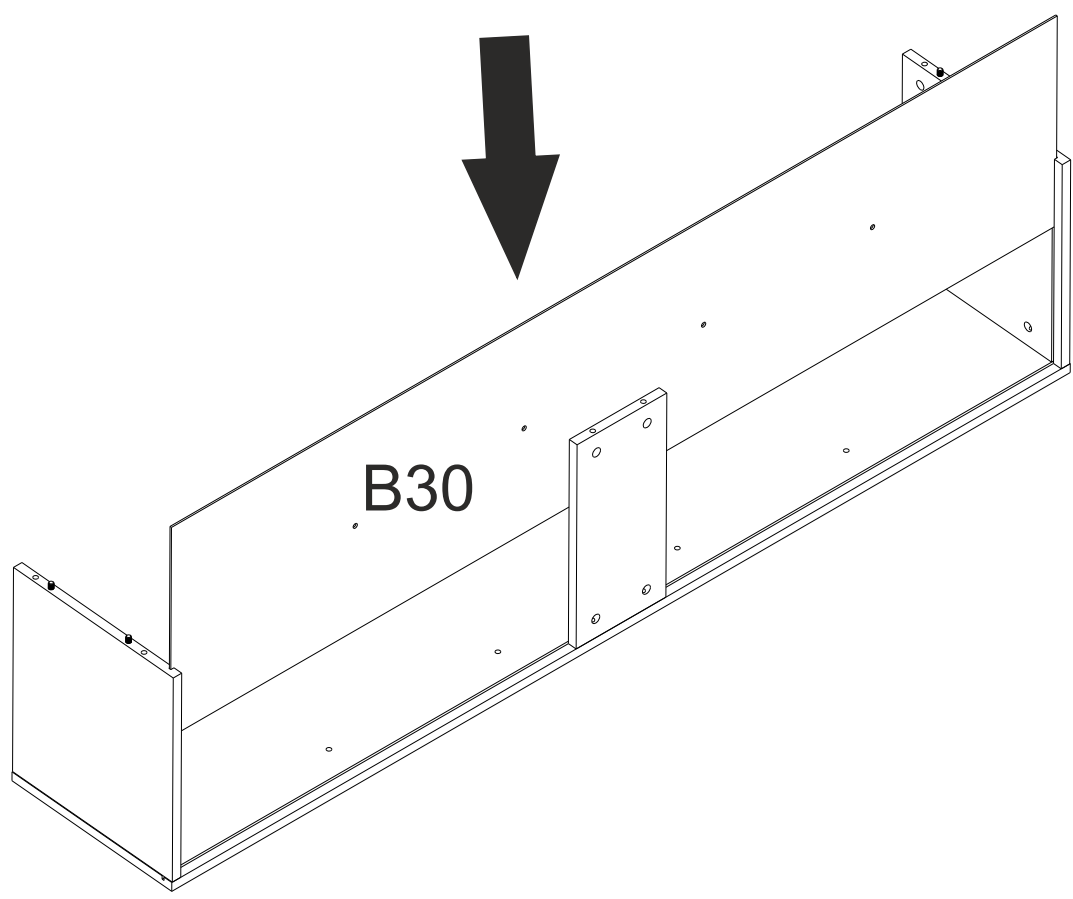

9

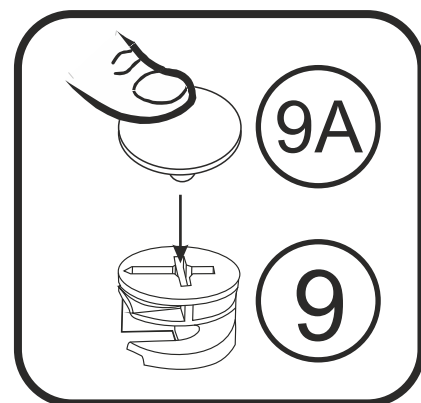
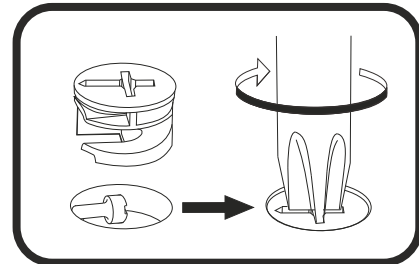
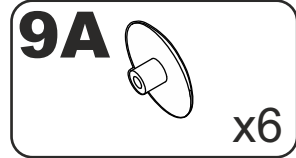
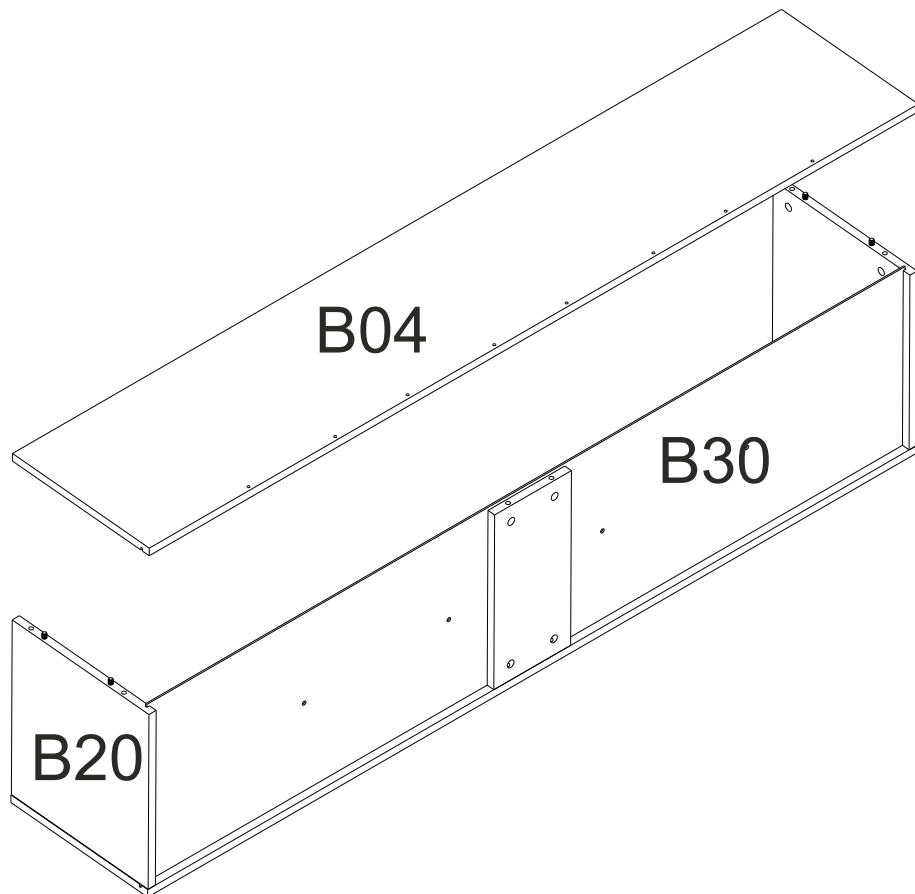

10

VERSION 1

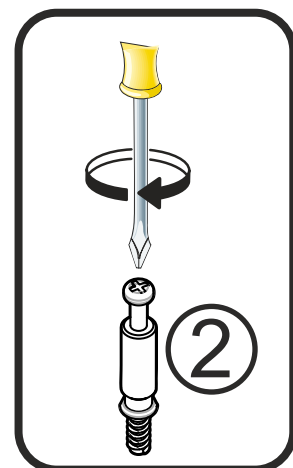
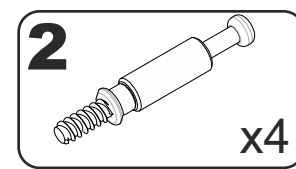
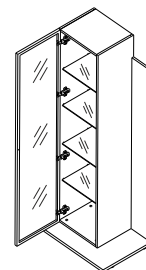
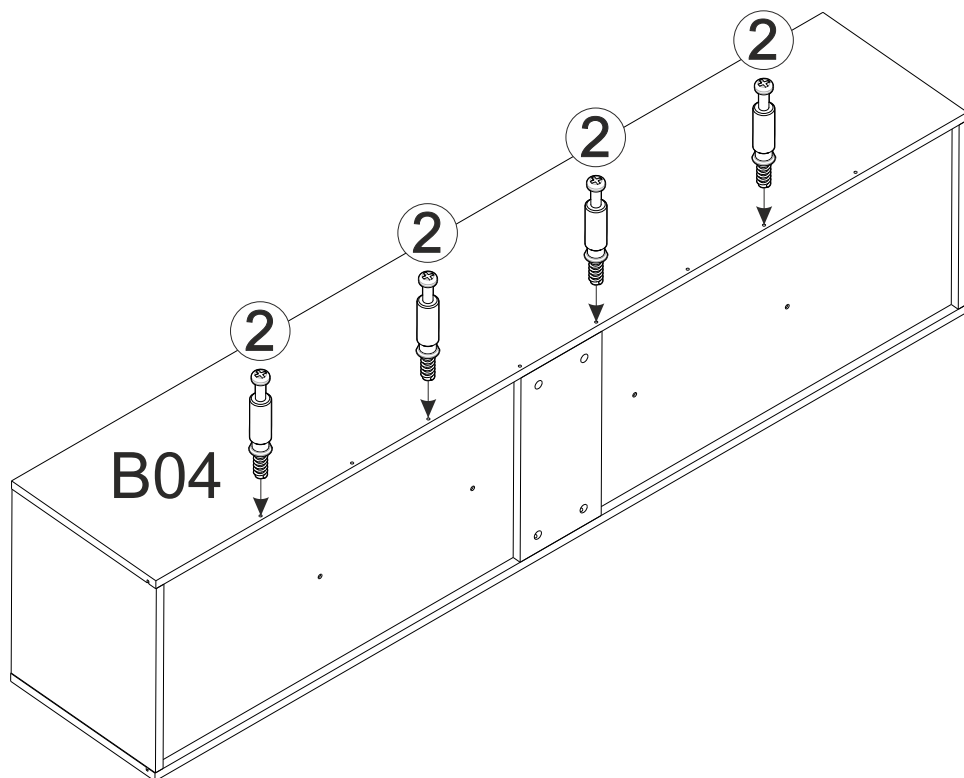

11

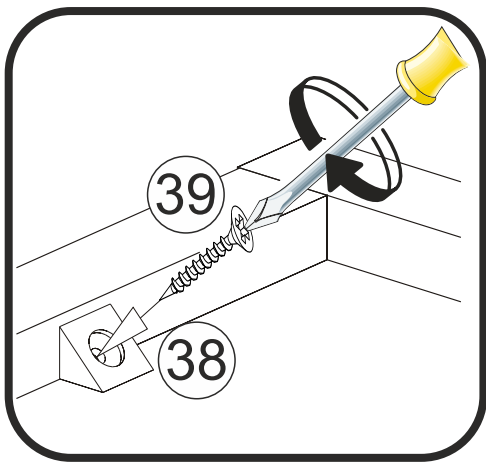
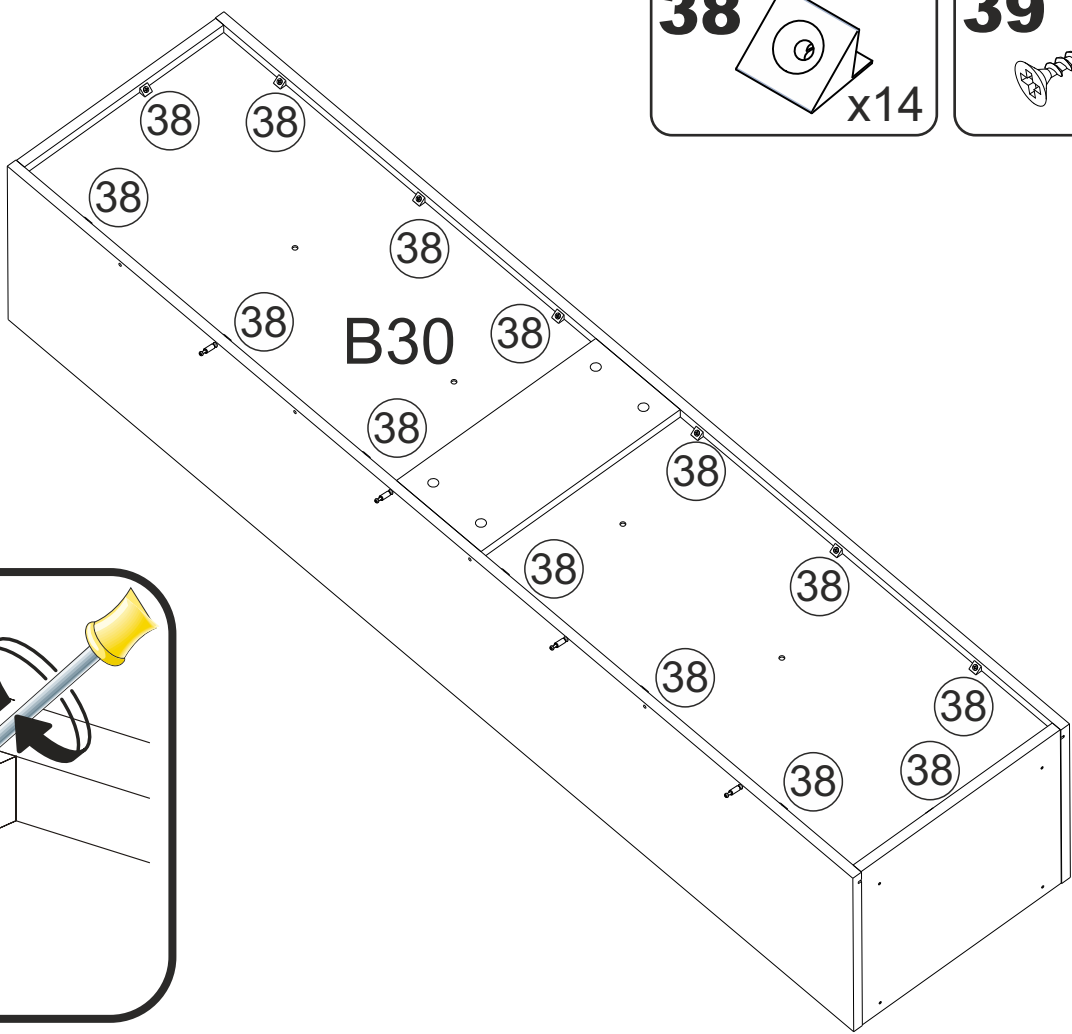
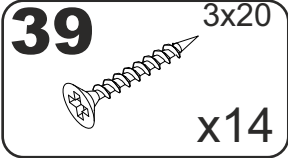
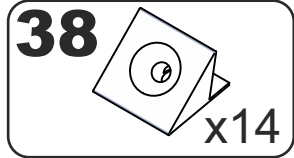

12

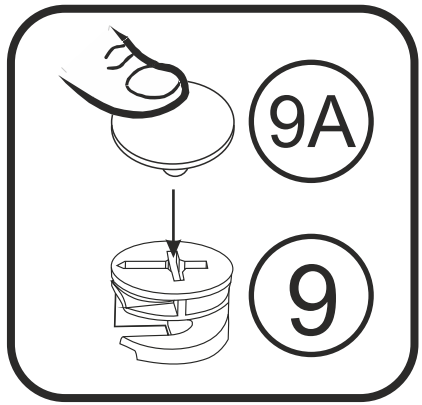
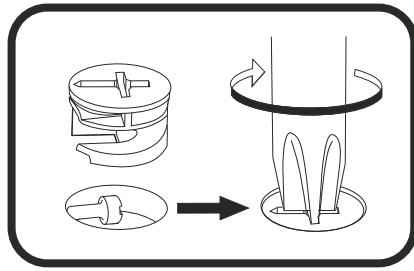
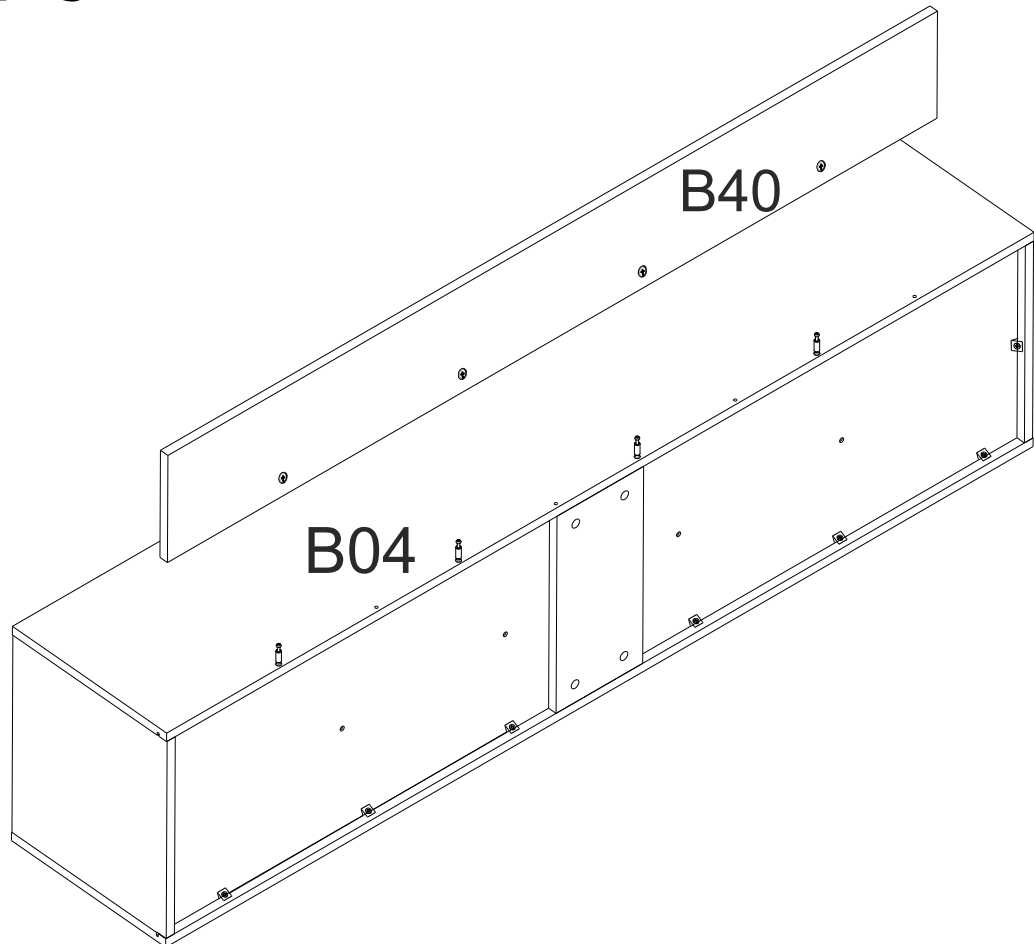
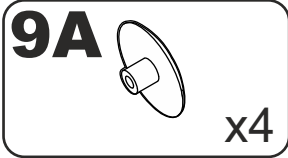

13

21 4x30
x4

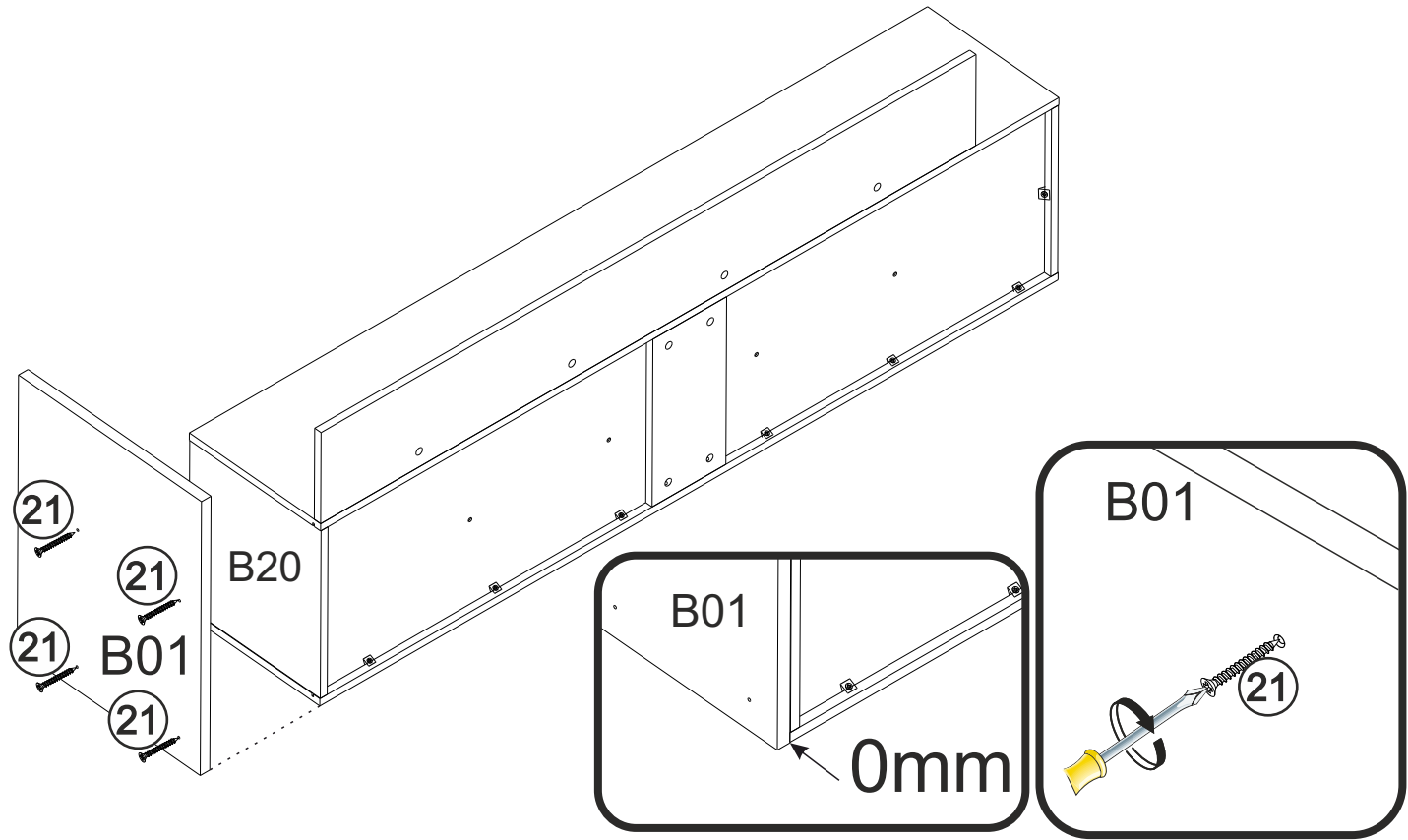
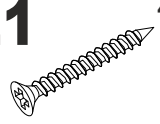

14

4A 4x16
x6

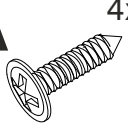

41
x2

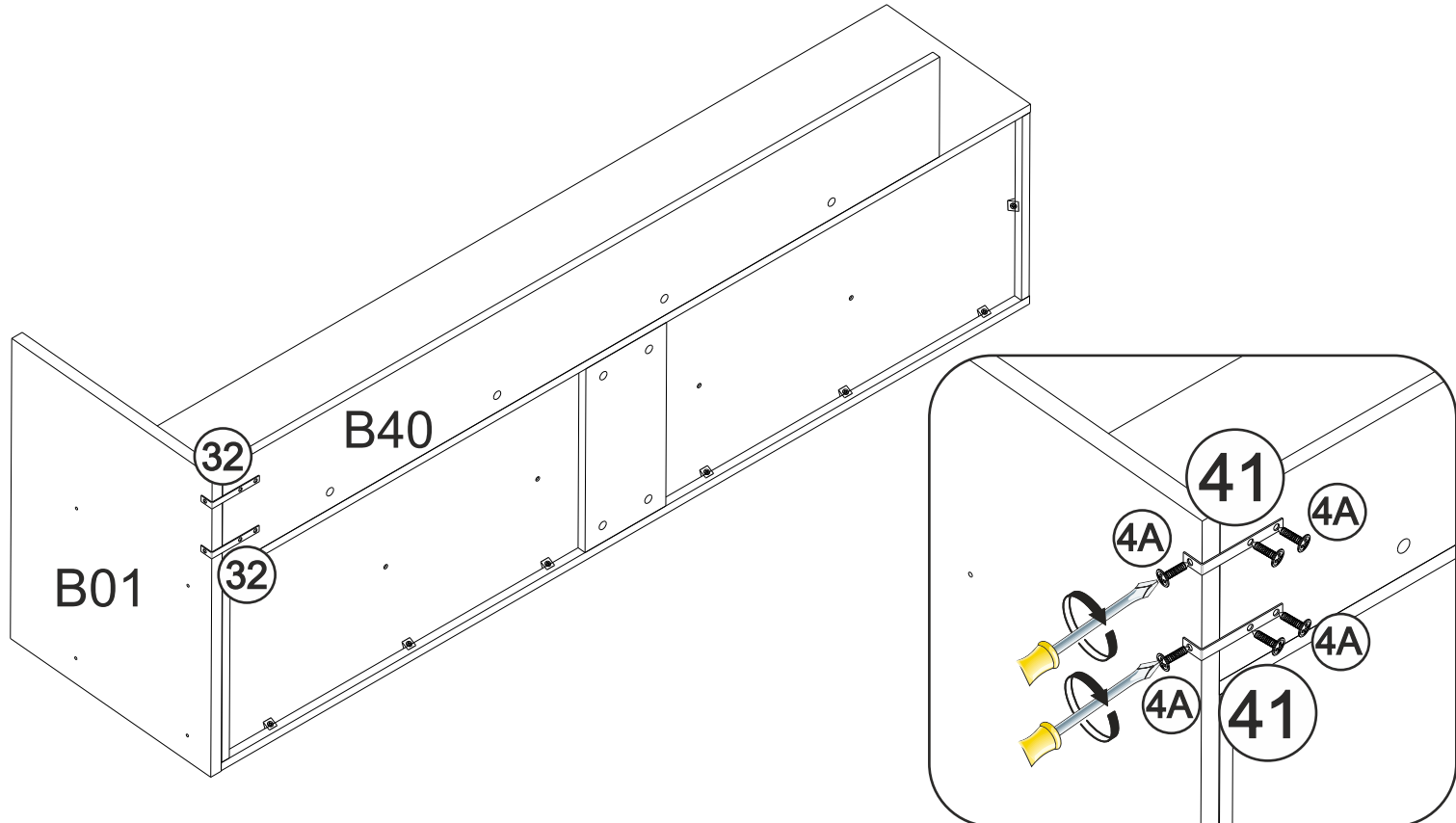
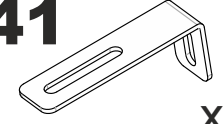

15

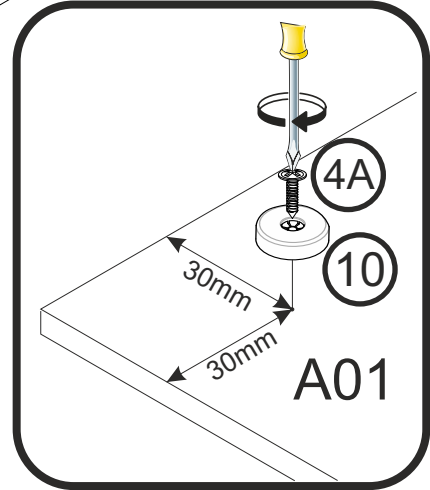
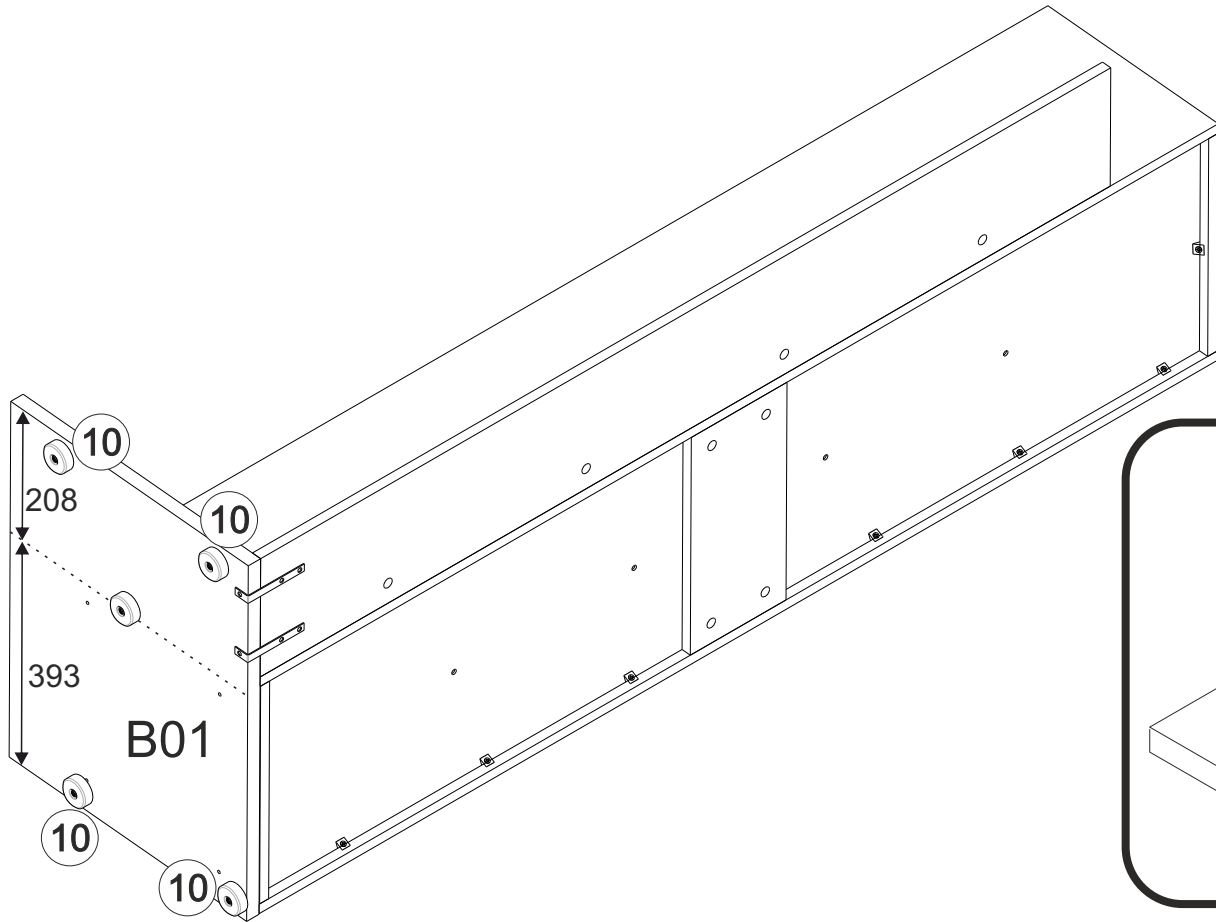
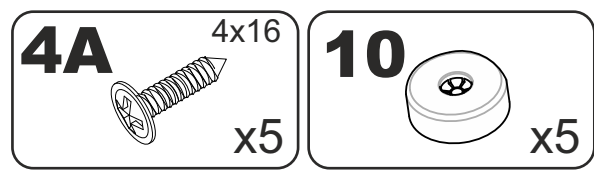

16

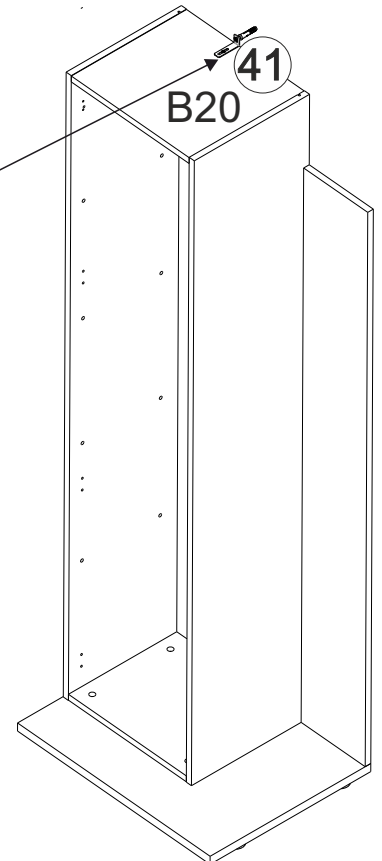
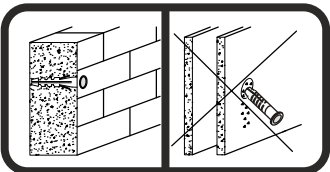
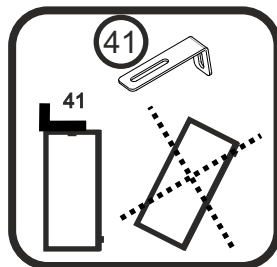
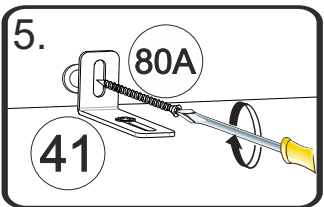
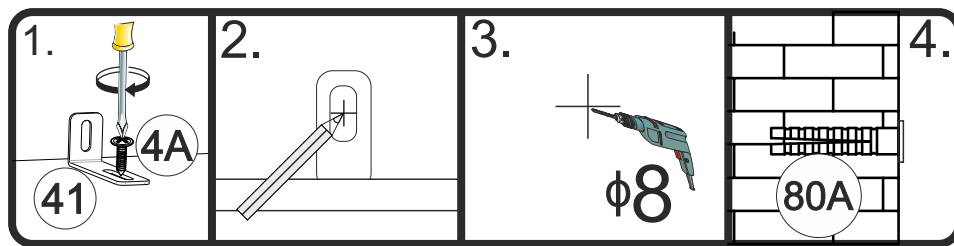

17

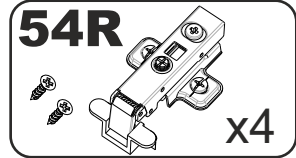
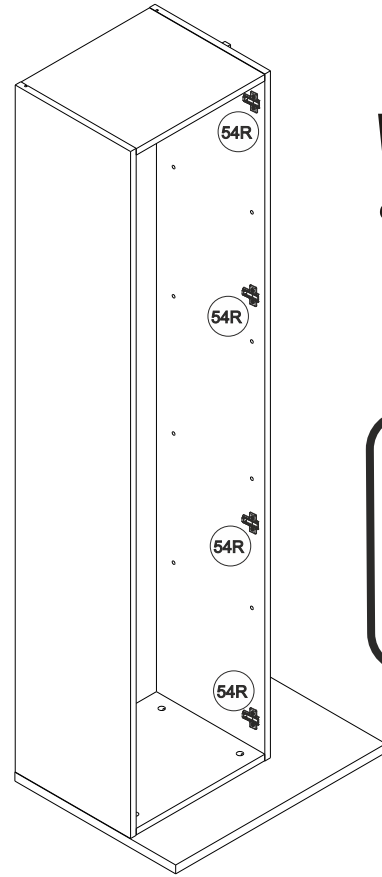
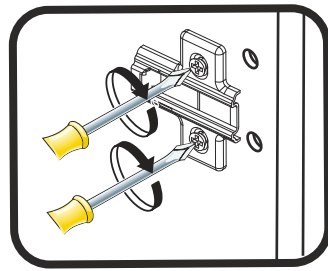
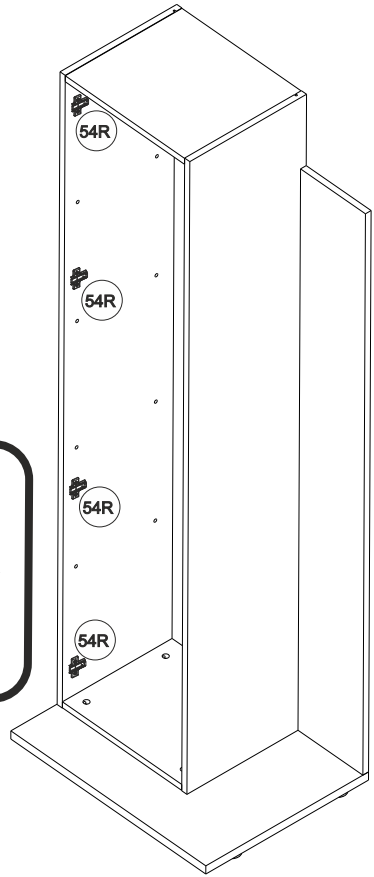
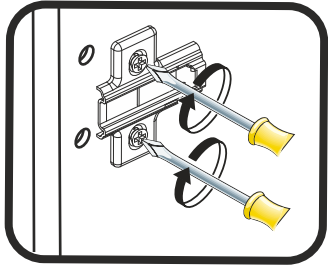
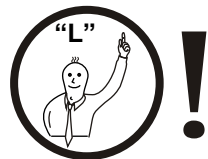

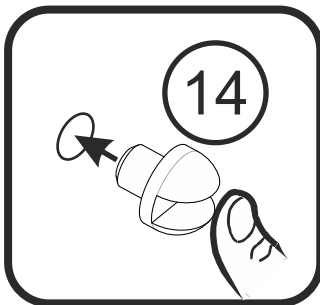
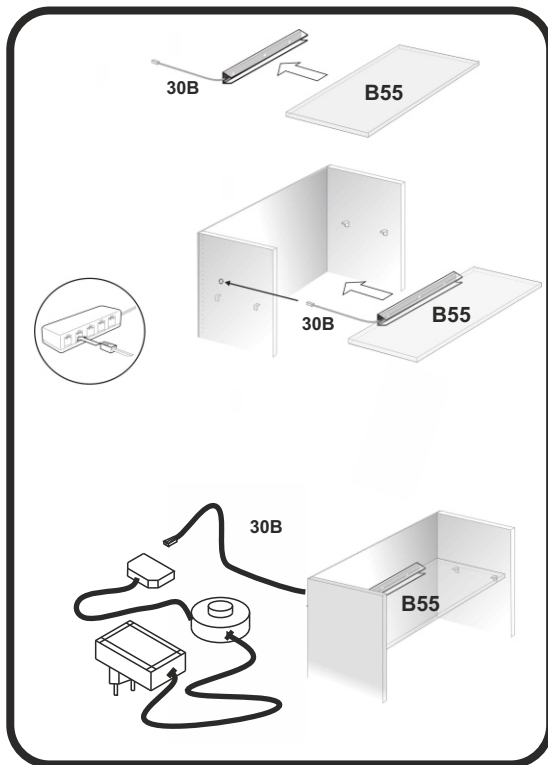
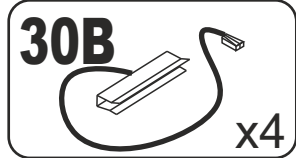
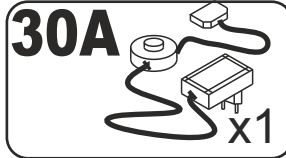
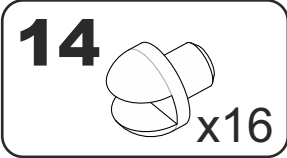
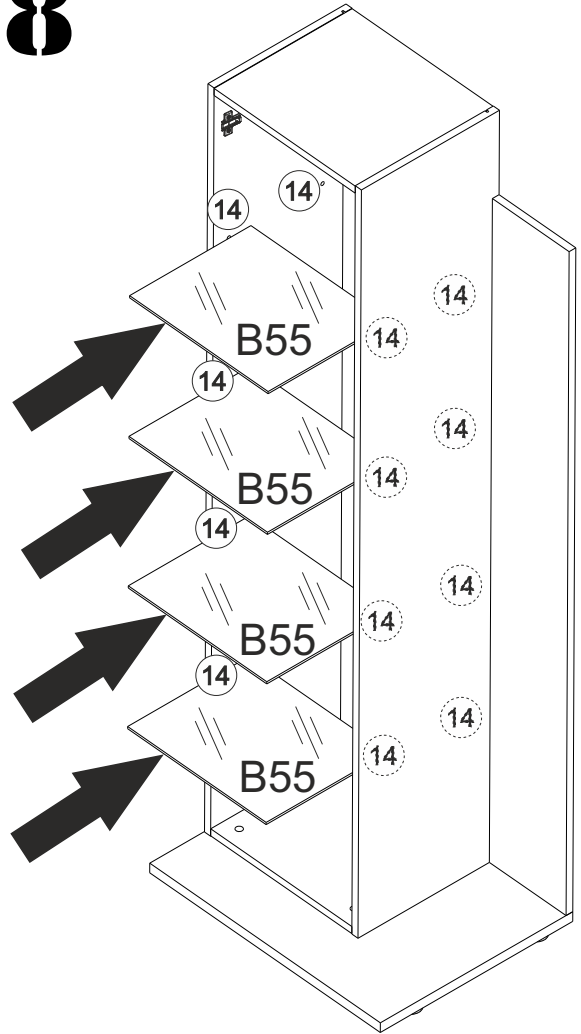

18



19



27  x2

3  x1

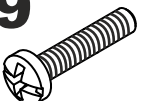
49  M4x25 x1

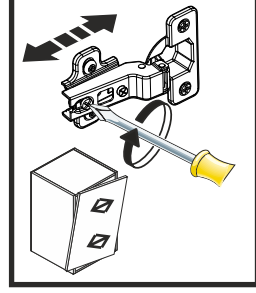
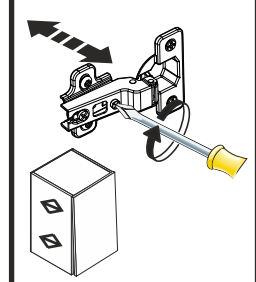
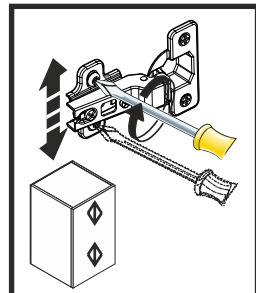
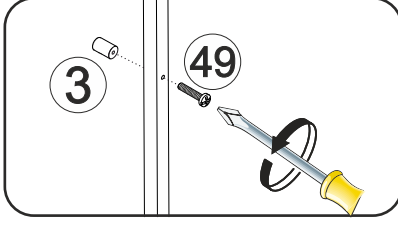
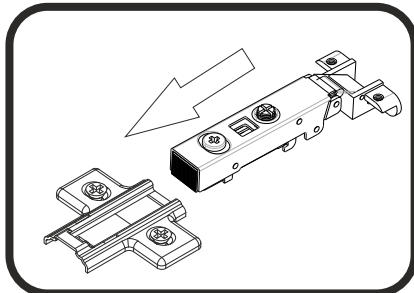
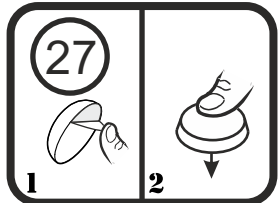
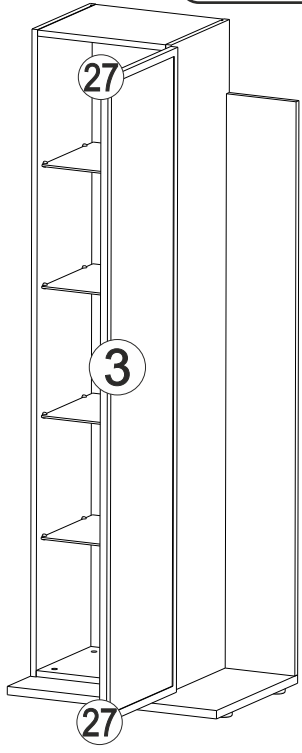
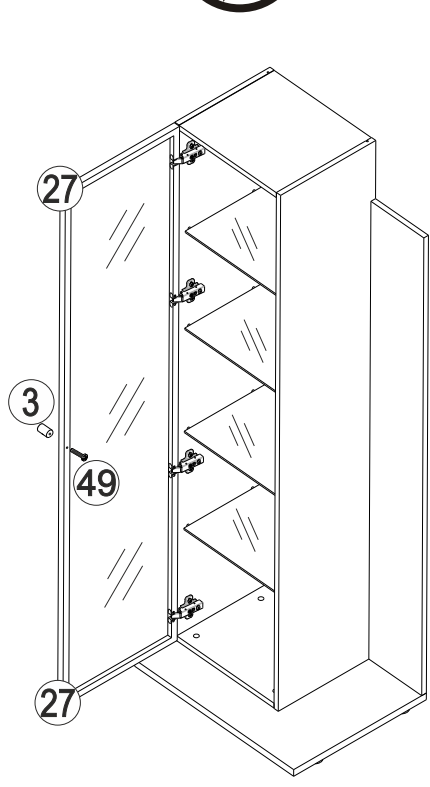

10

VERSION 2

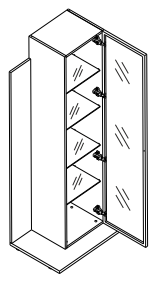

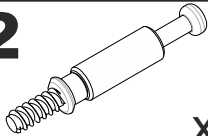
2  x4

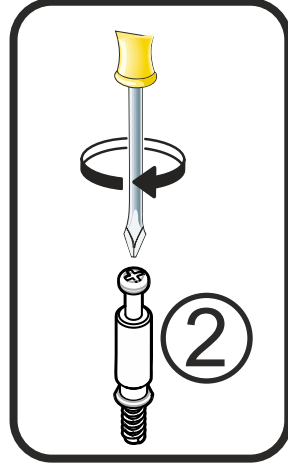
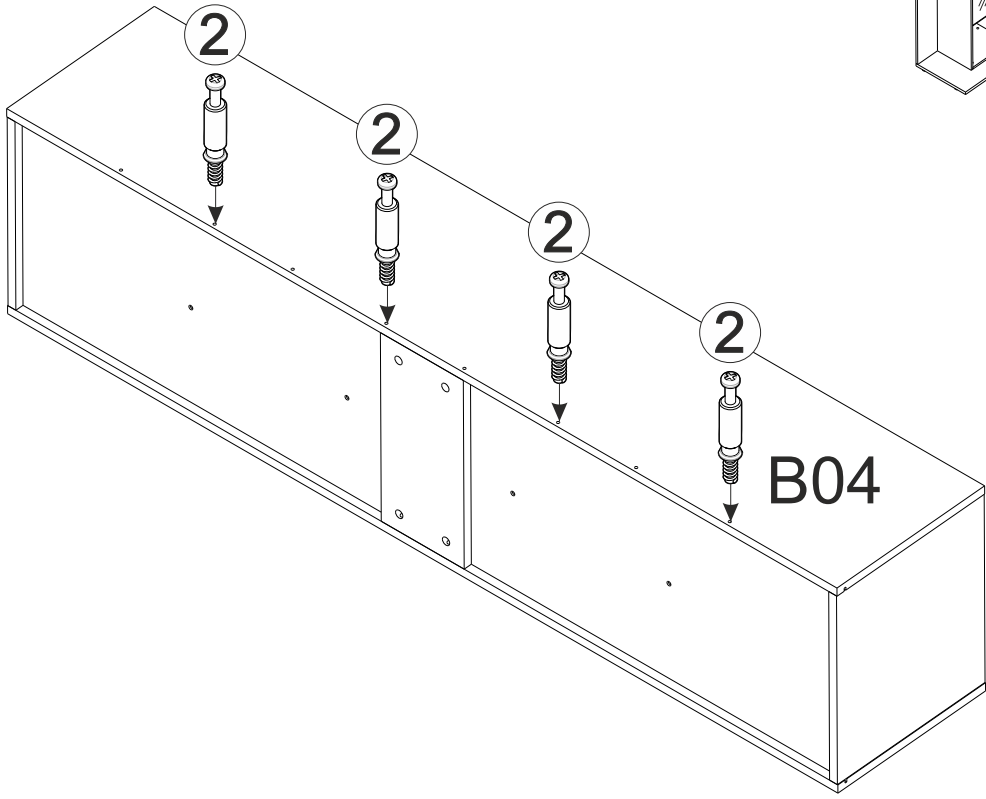

11

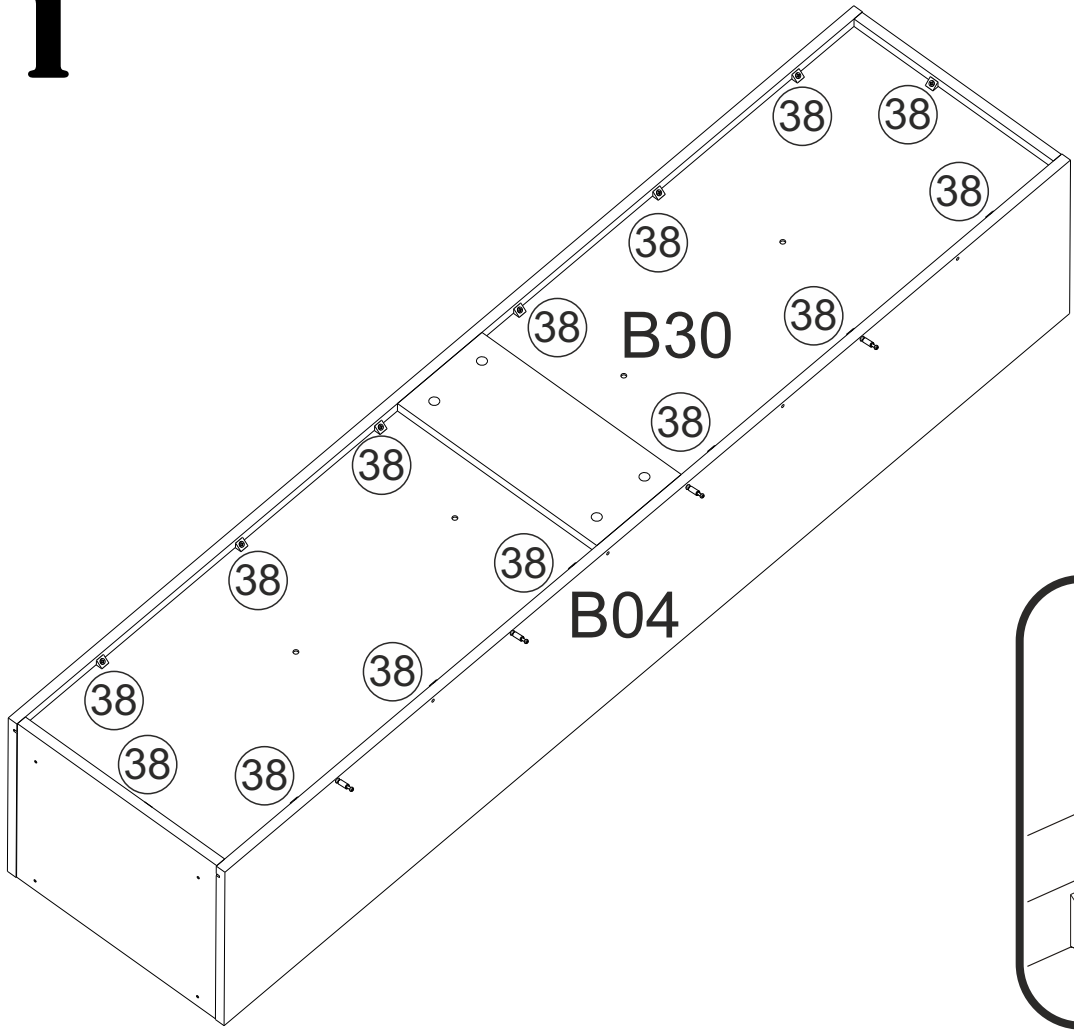

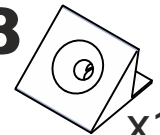

39 3x20

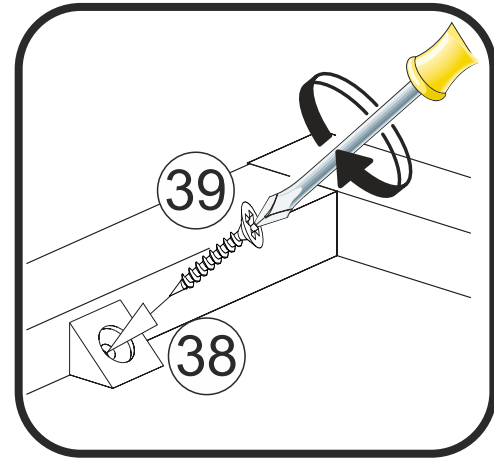
x14

38

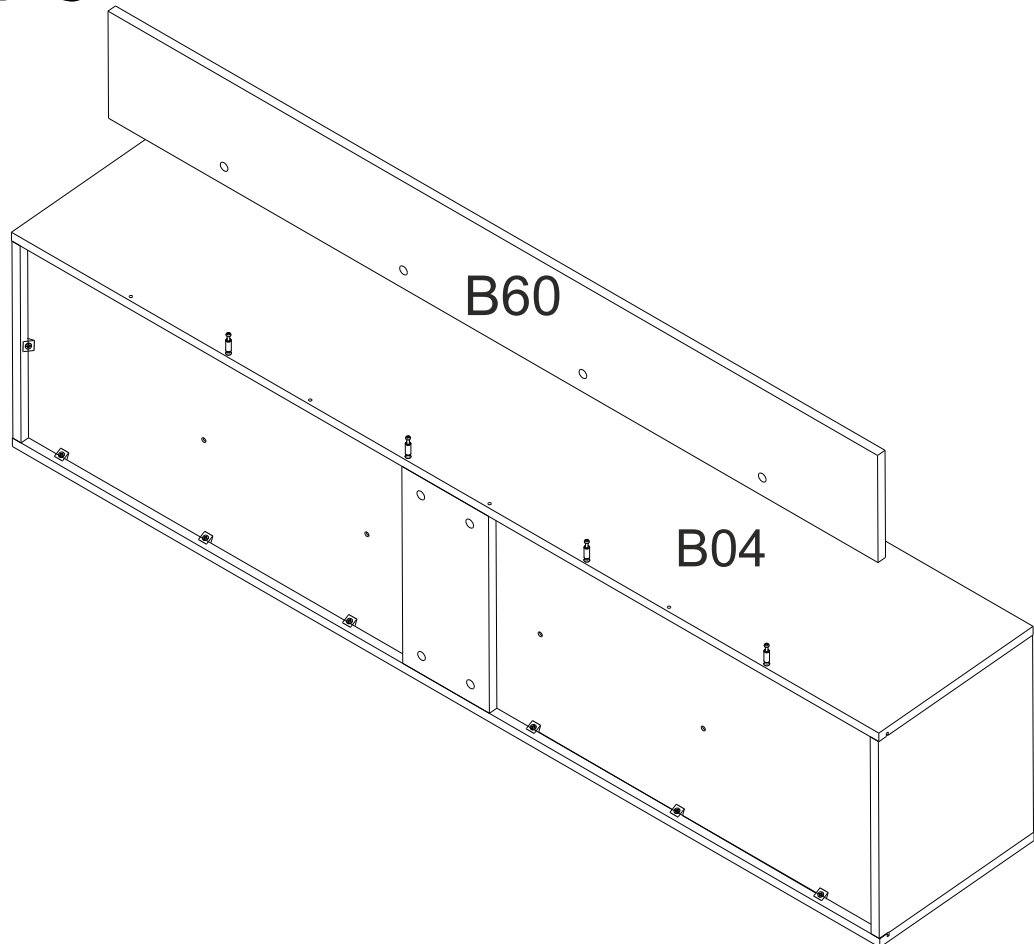
x14



12

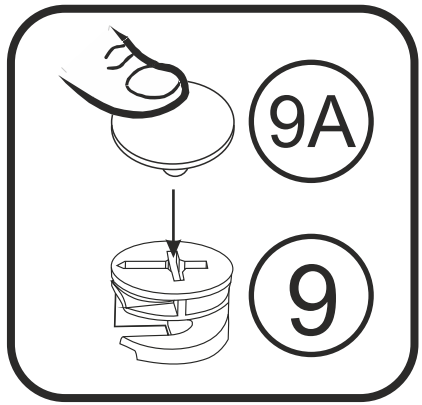
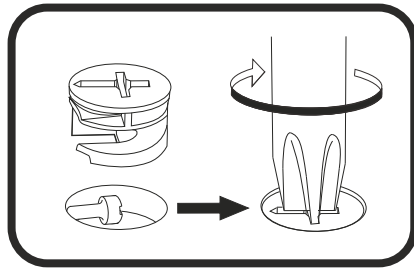

9A

x4

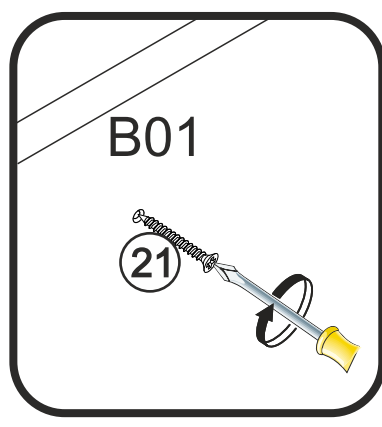
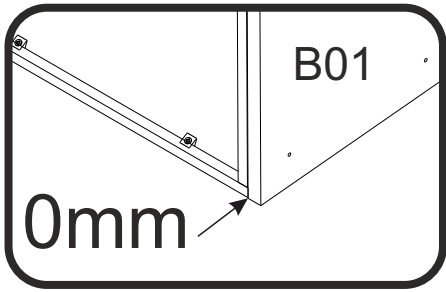
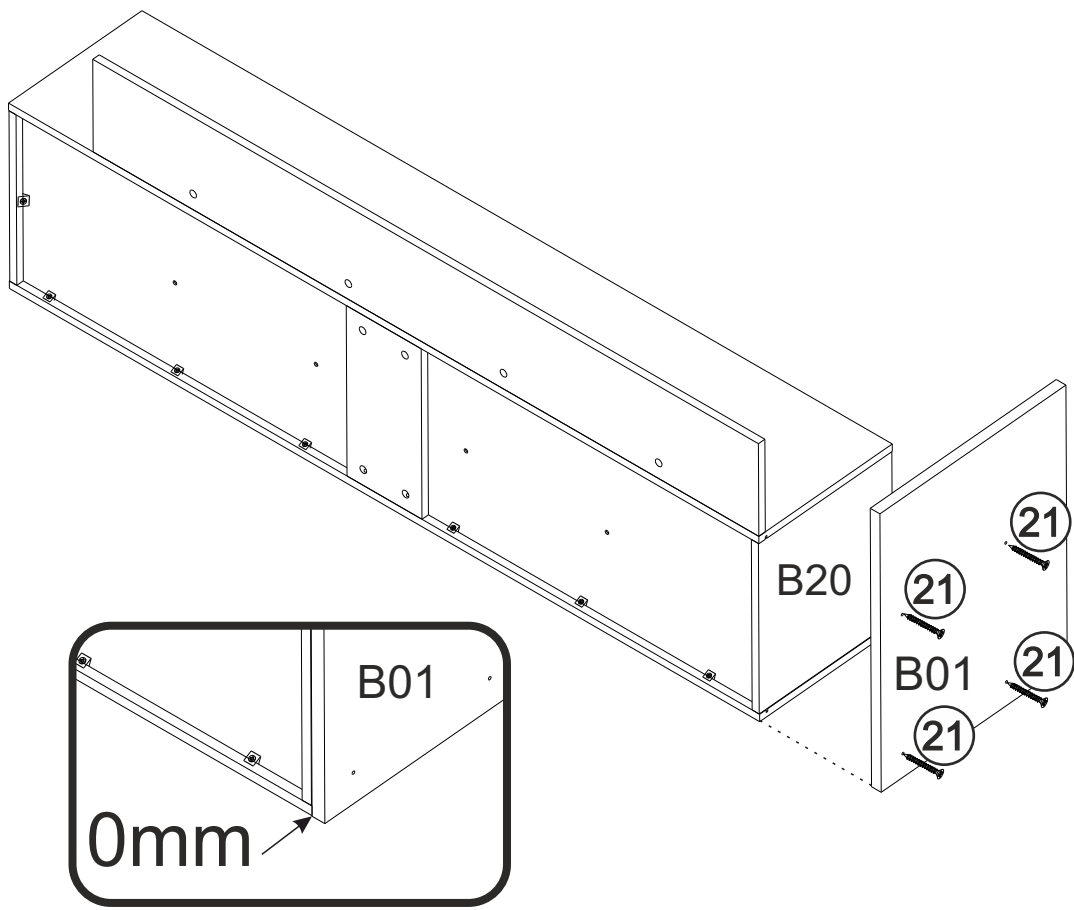
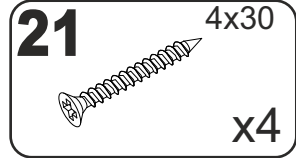

13

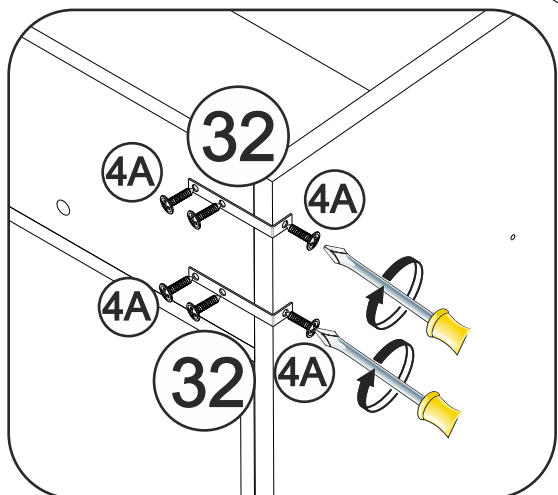
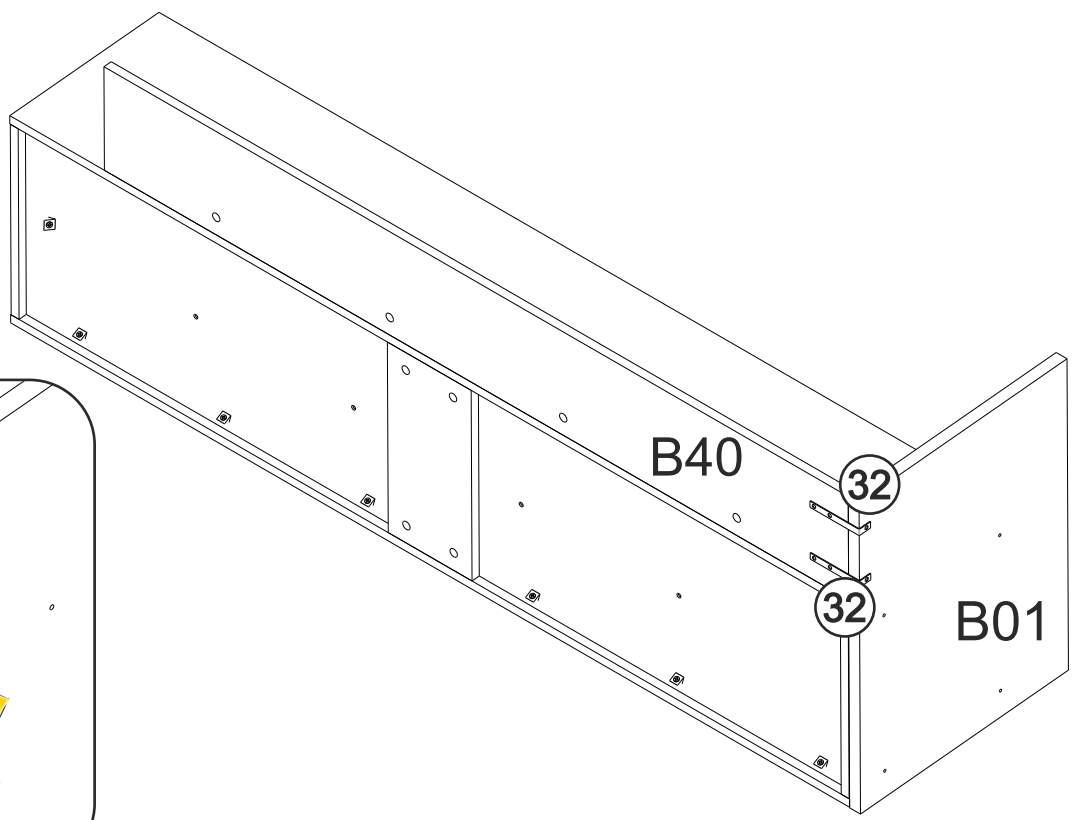
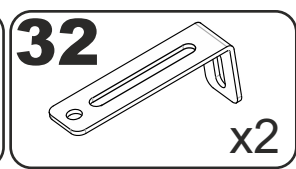
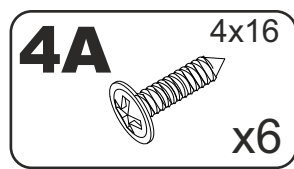

14



15

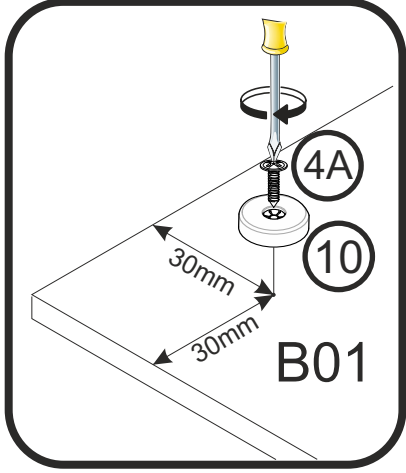
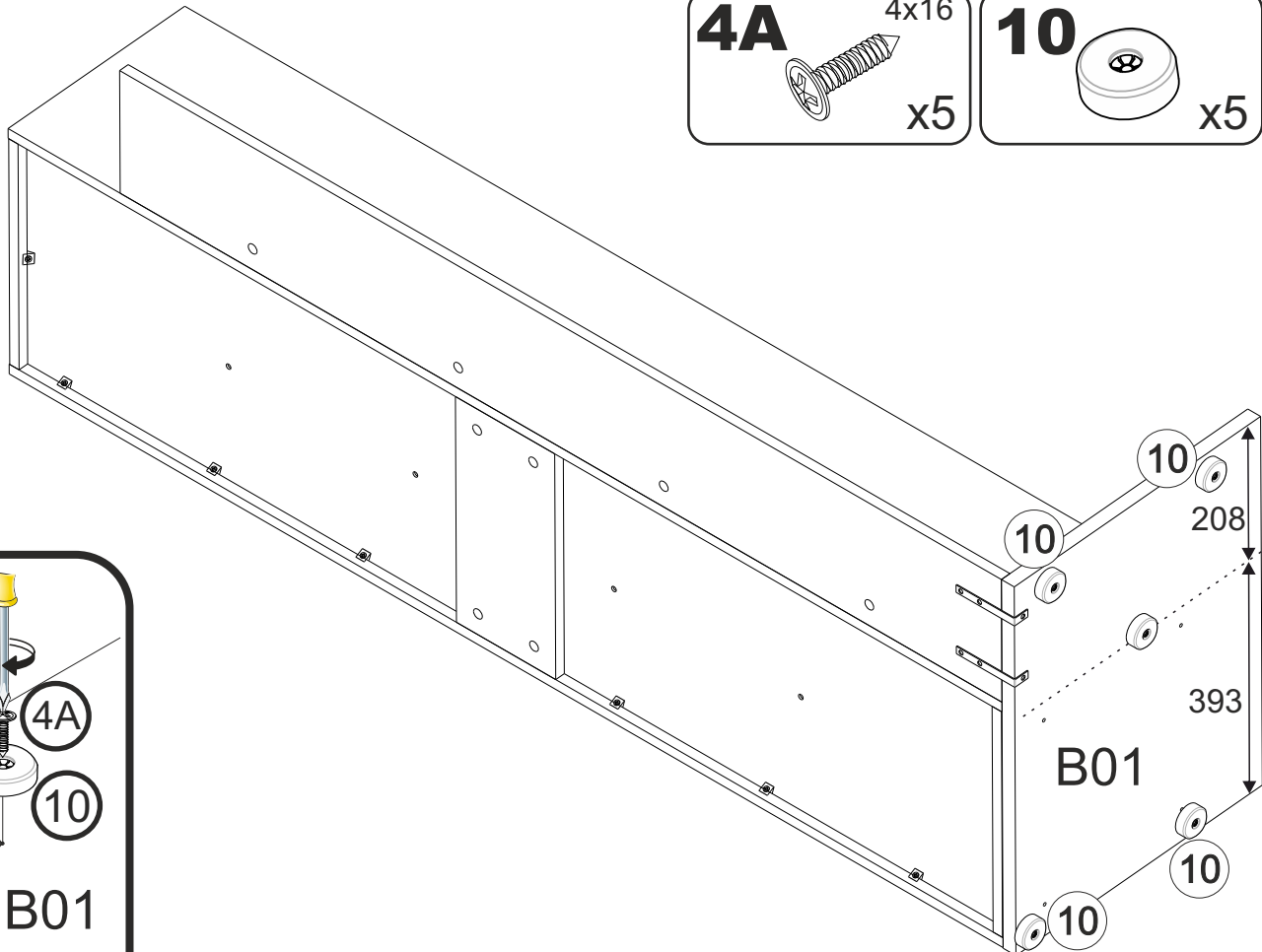
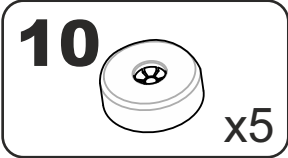
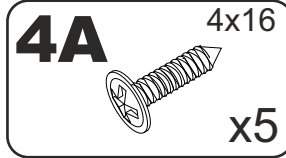

16

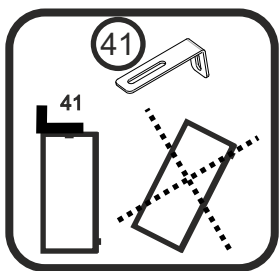
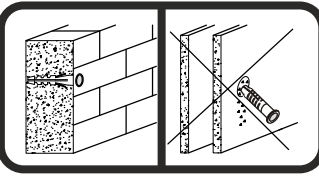
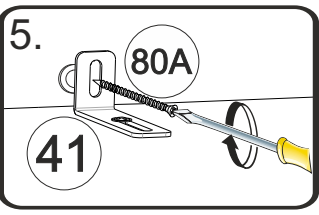
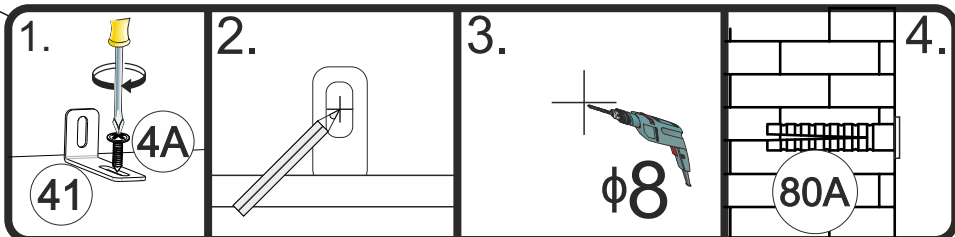
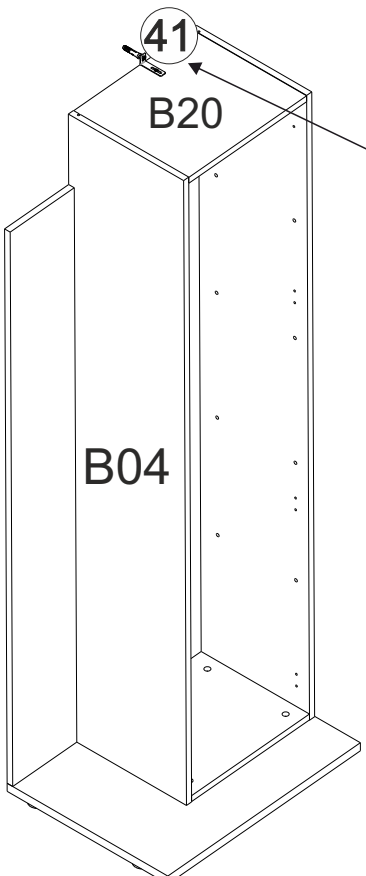
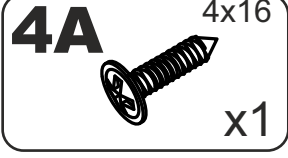
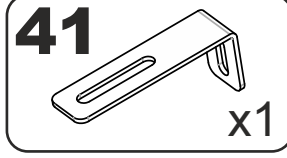

17

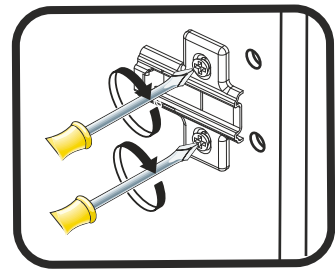
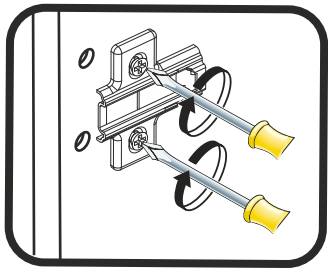
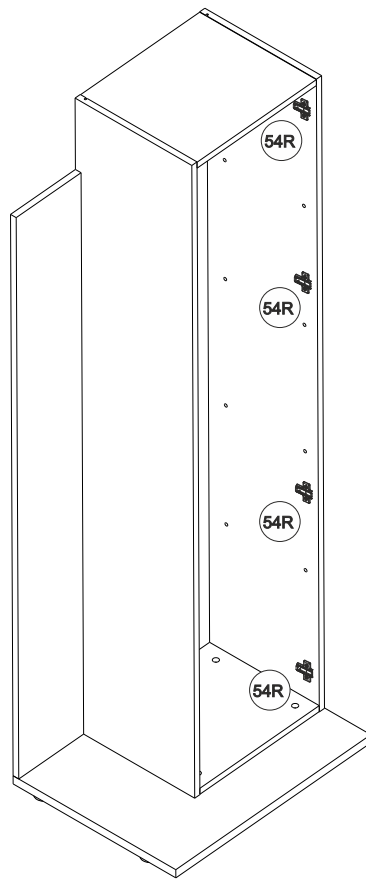
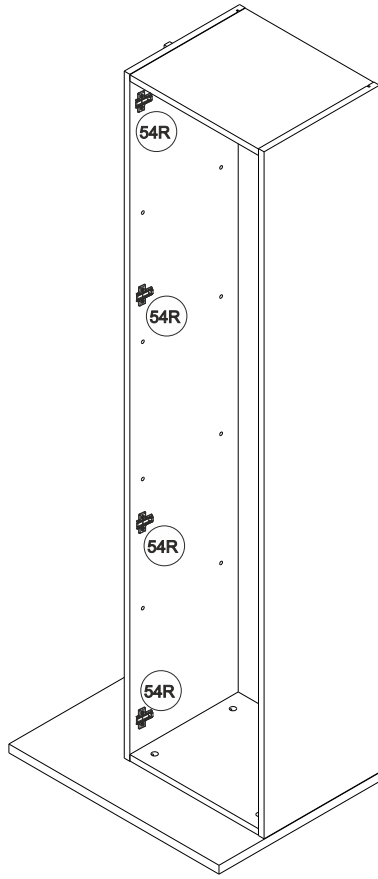
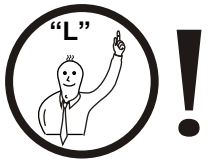

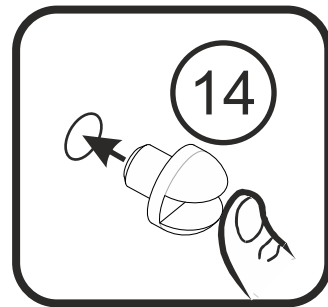
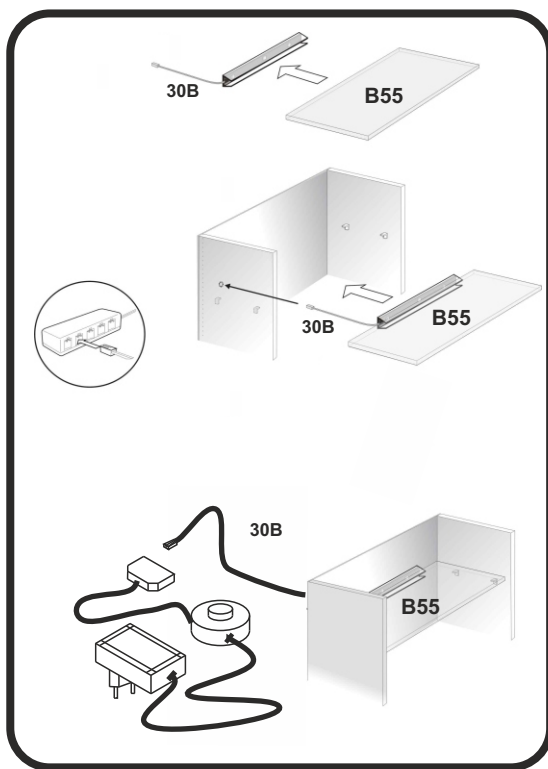
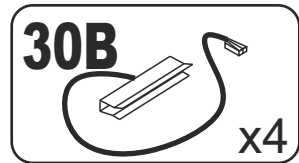
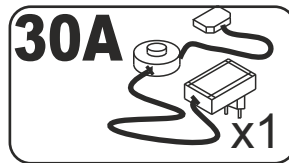
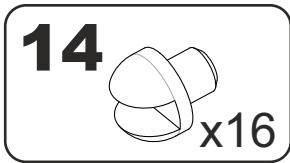
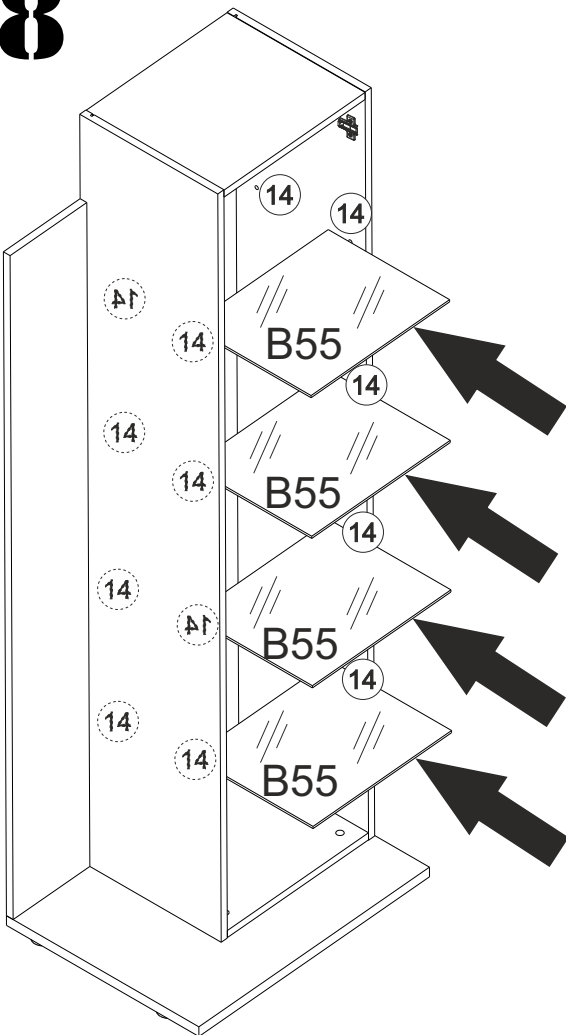

18



19



27  x2

3  x1

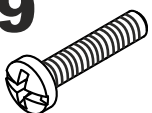
49  M4x25 x1

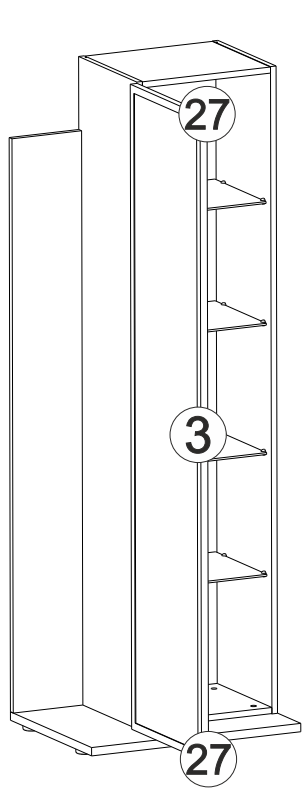
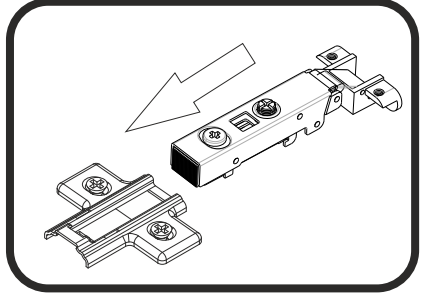
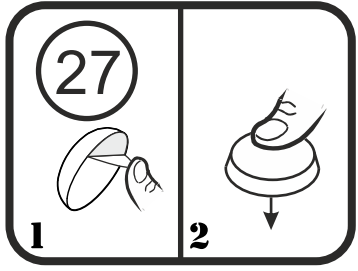
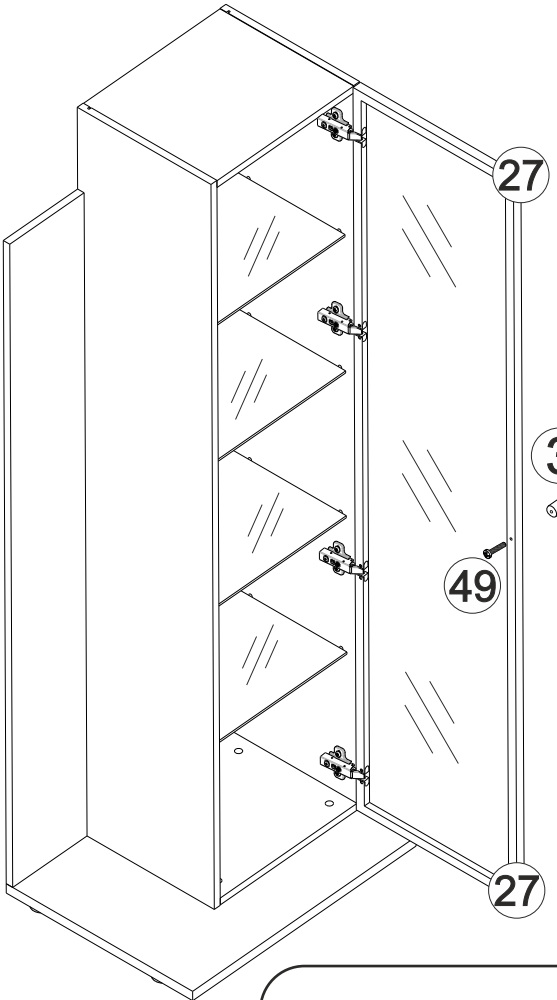

"R"

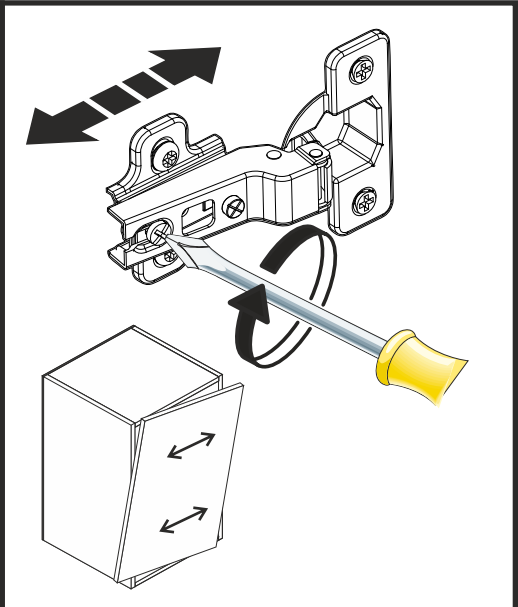
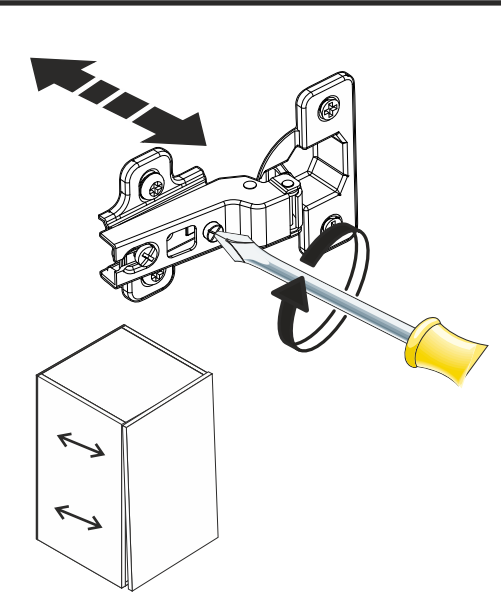
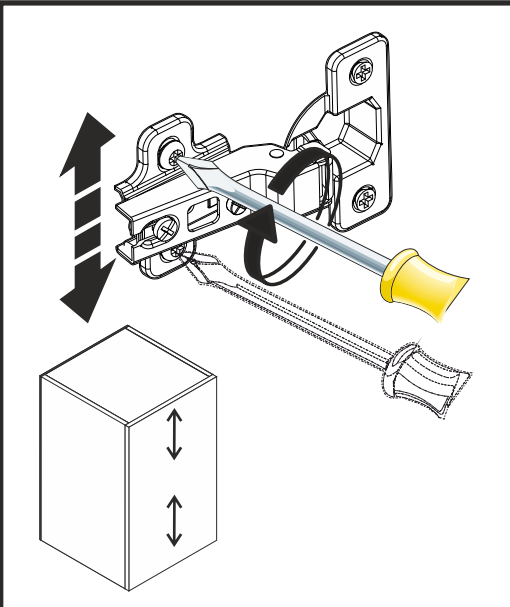
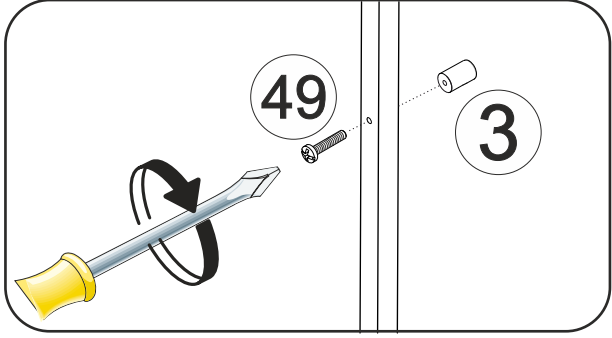

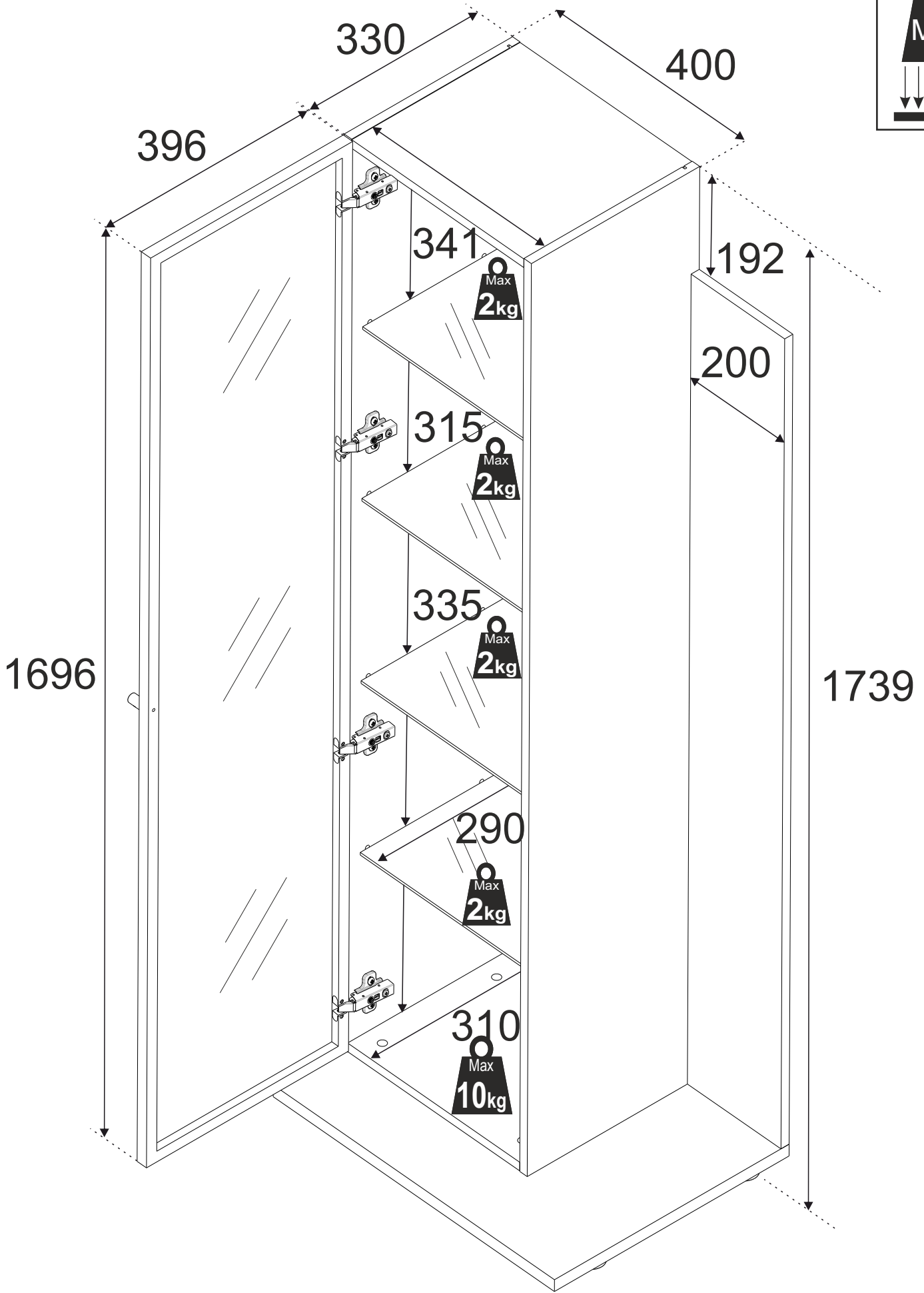
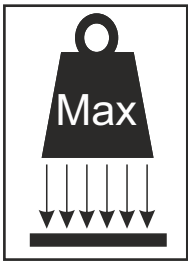

OPTION

55516 + 55517

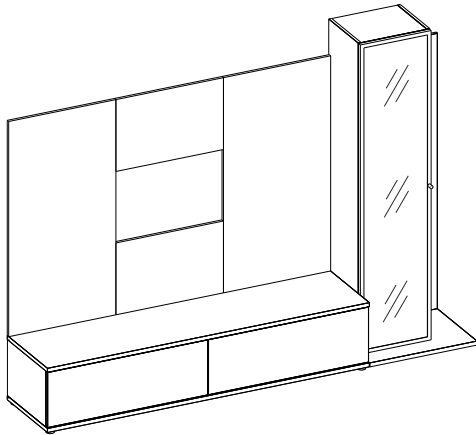

55517 + 55516

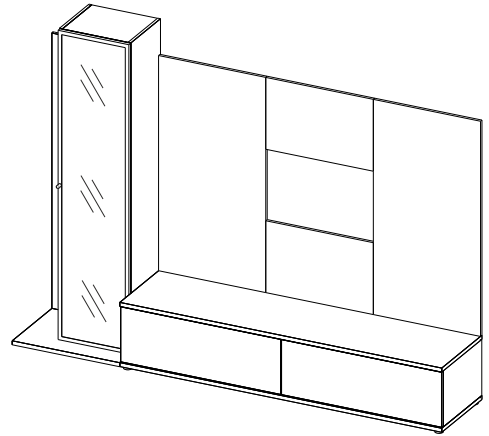

2x 55517 + 55516

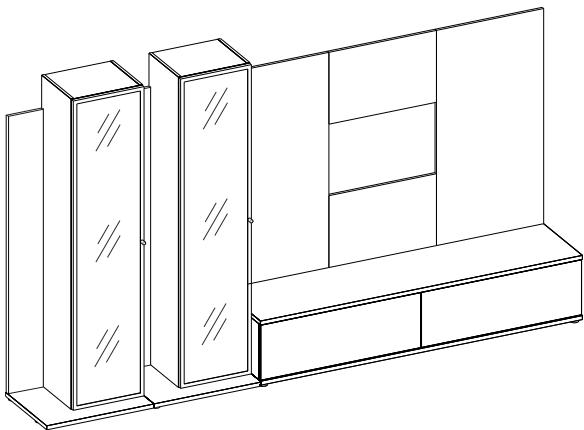

55516 + 2x 55517

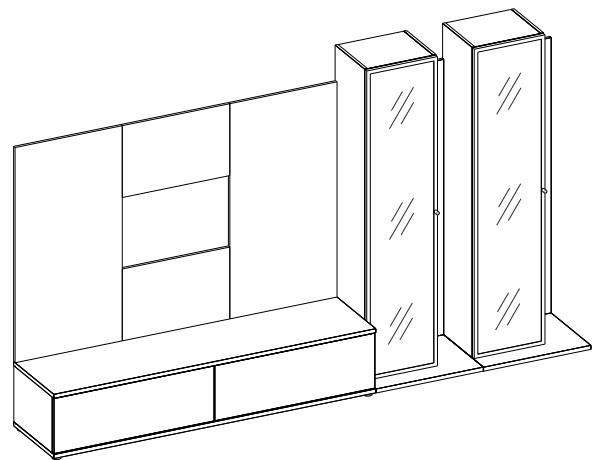

2x 55517 + 55516

