











-  4 x A
-  8 x B
-  12 x C
-  2 x D
-  2 x E

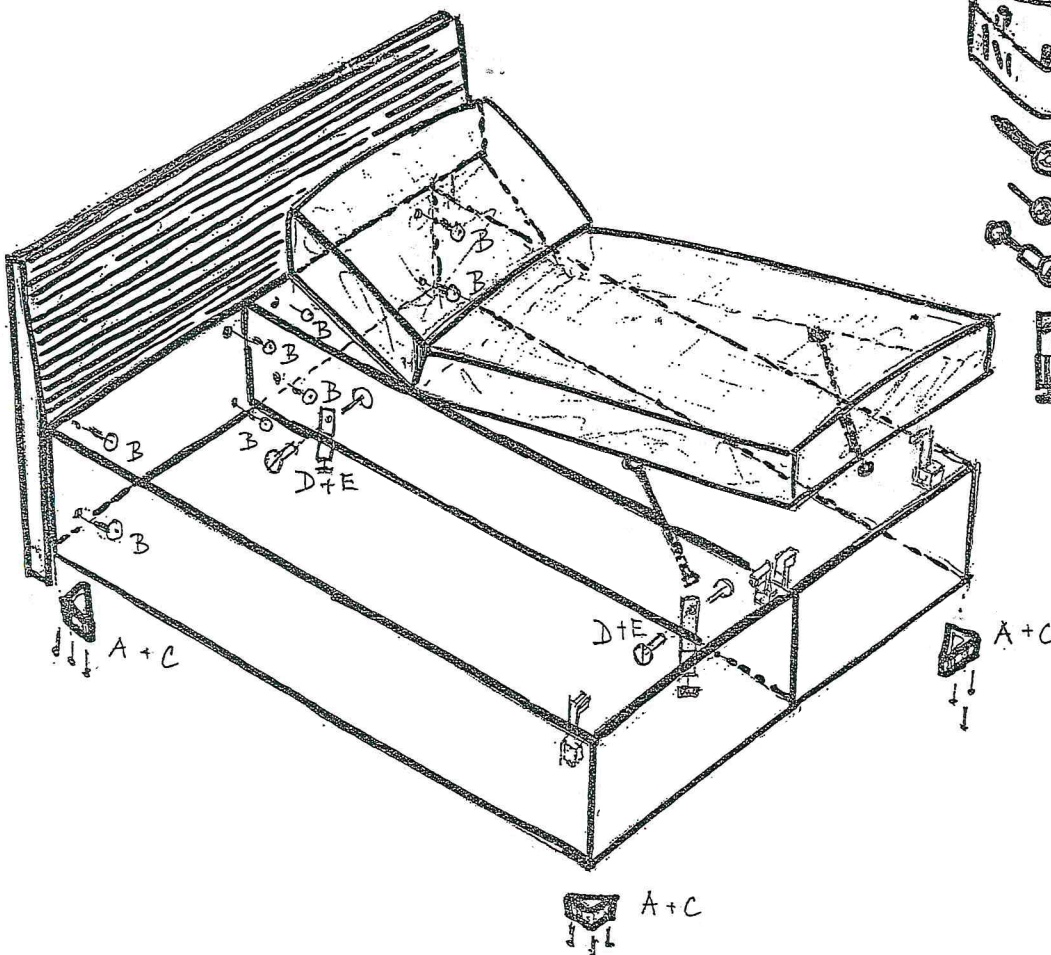

-  4 x A
-  8 x B
-  12 x C
-  2 x D
-  2 x E