

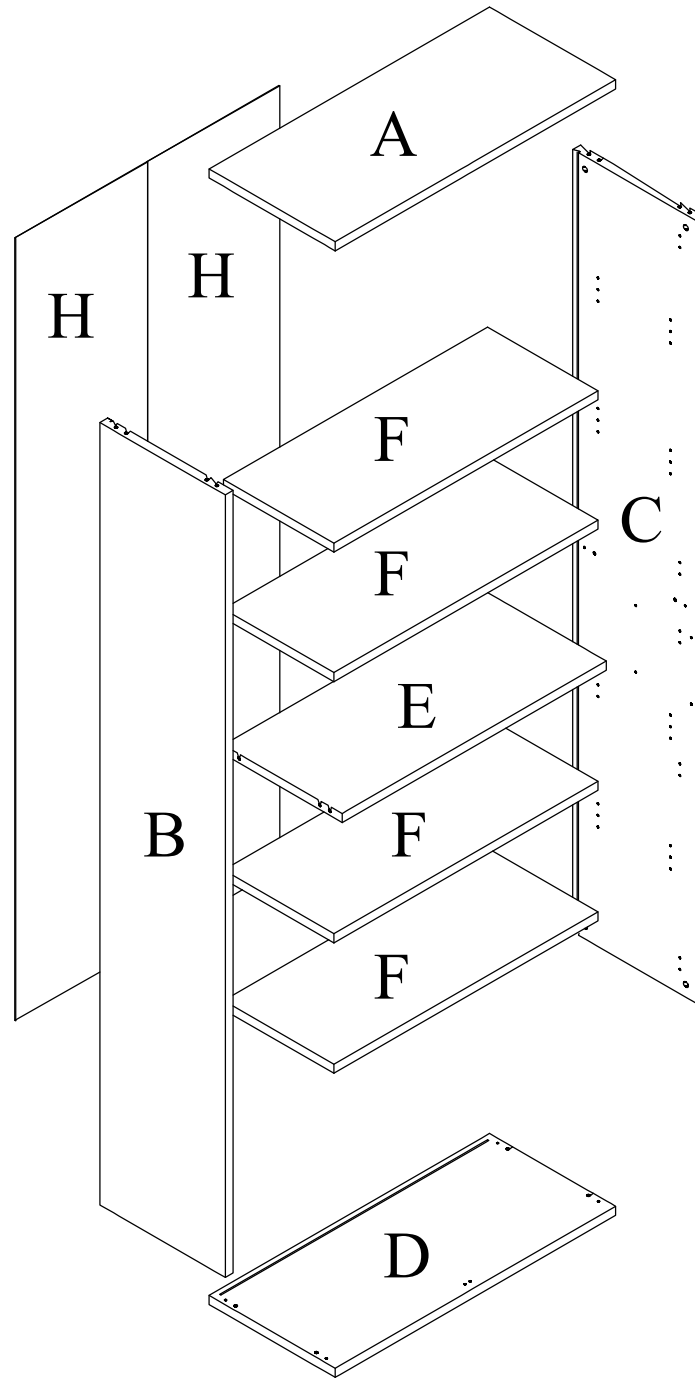

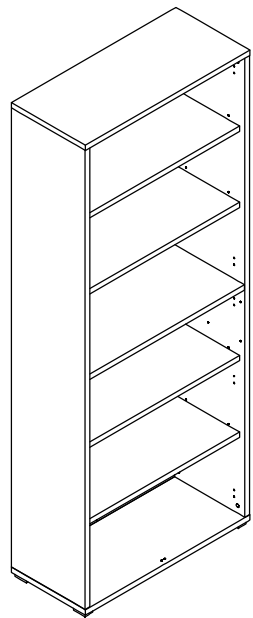

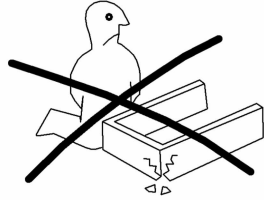

Sc-221
RIO

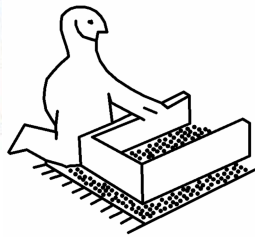
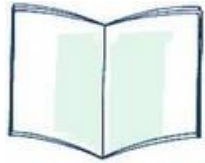
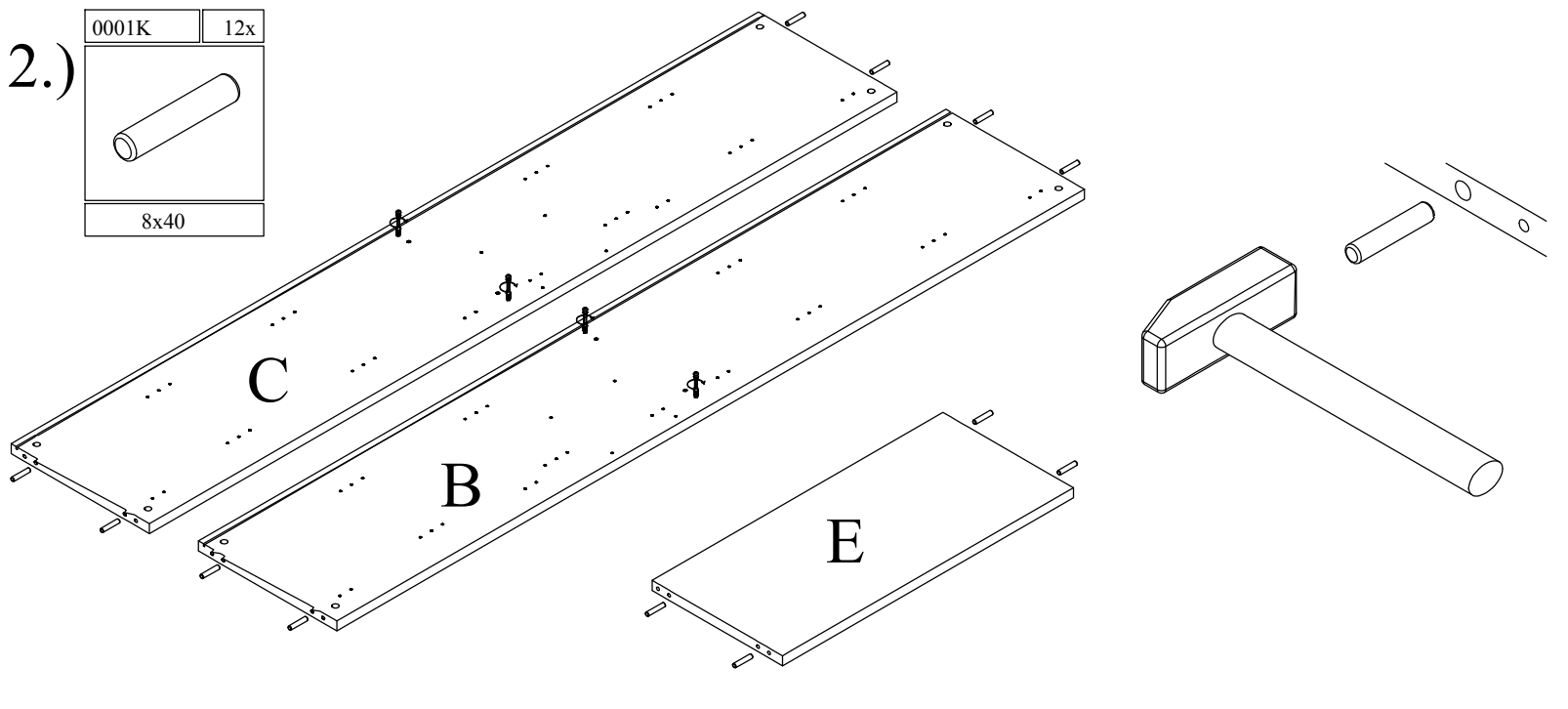
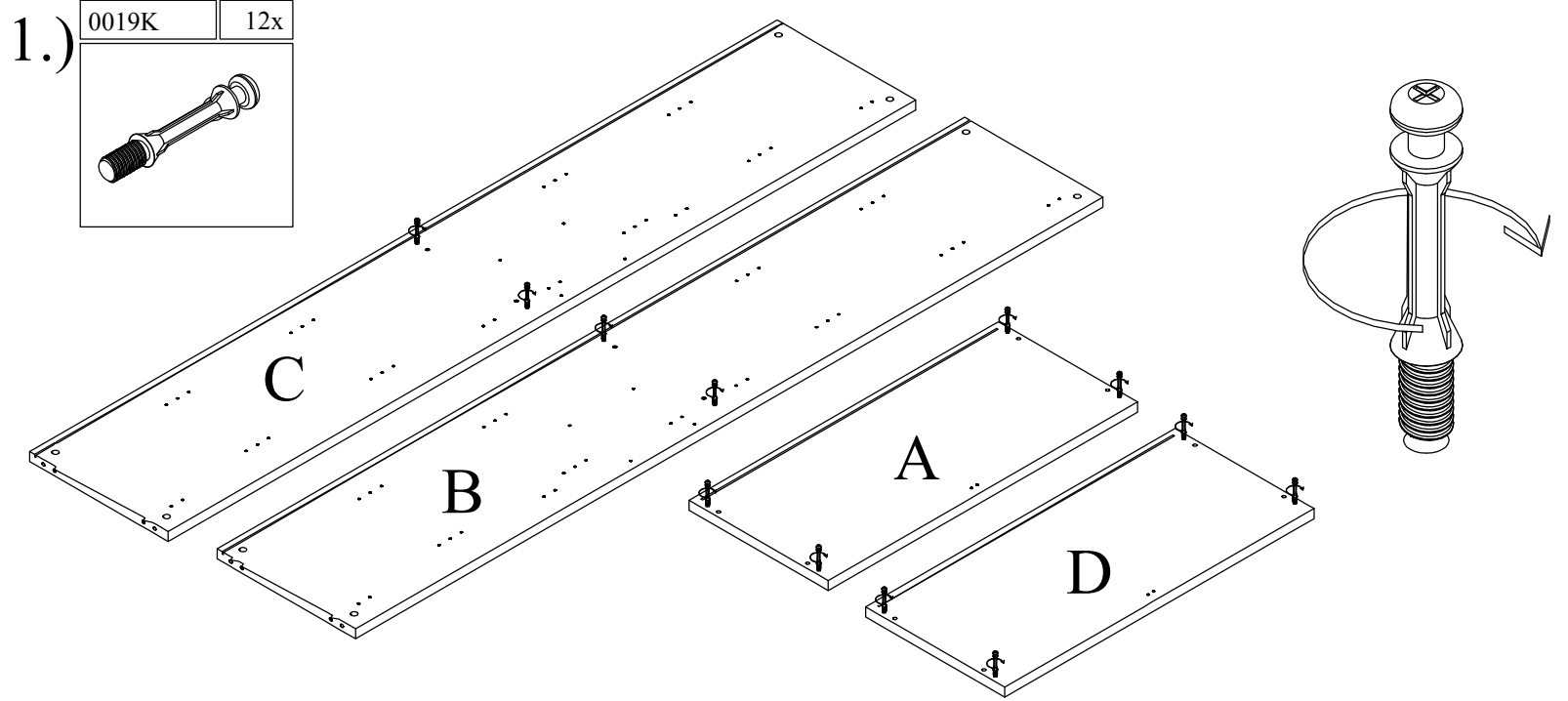
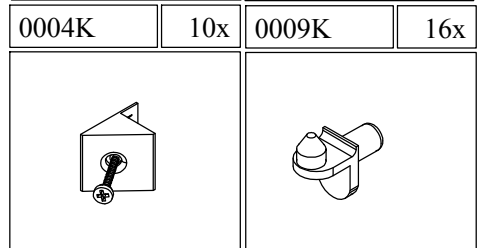
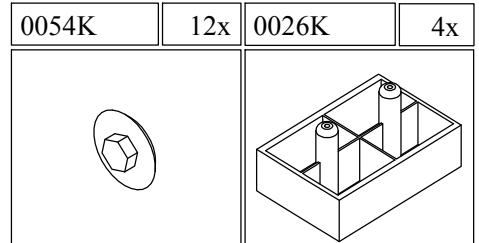
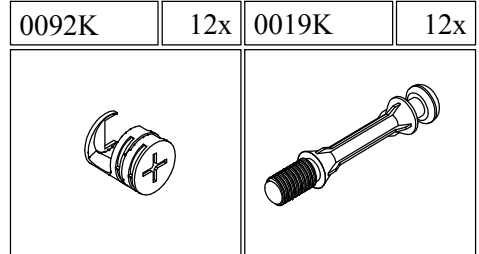
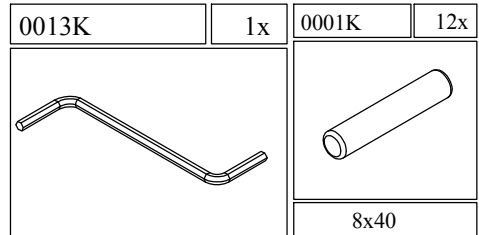
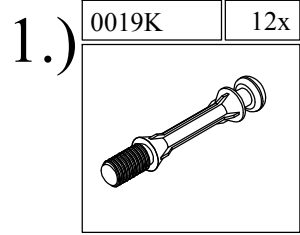
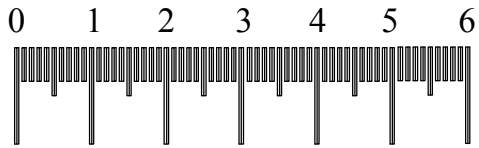

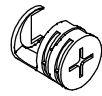

3.)

0092K	8x	0054K	8x
			

0004K	2x	0092K	4x	0054K	4x
					

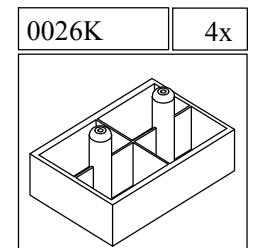
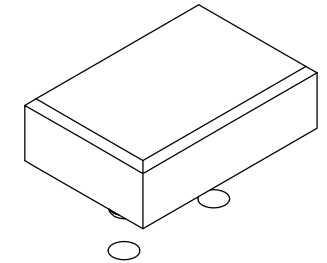
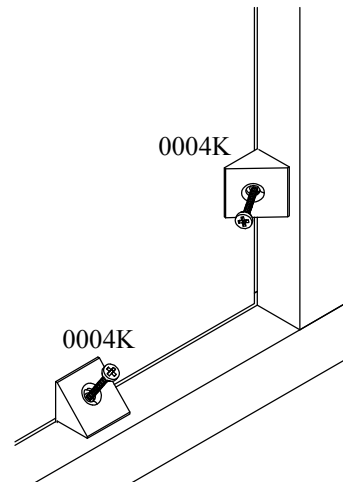
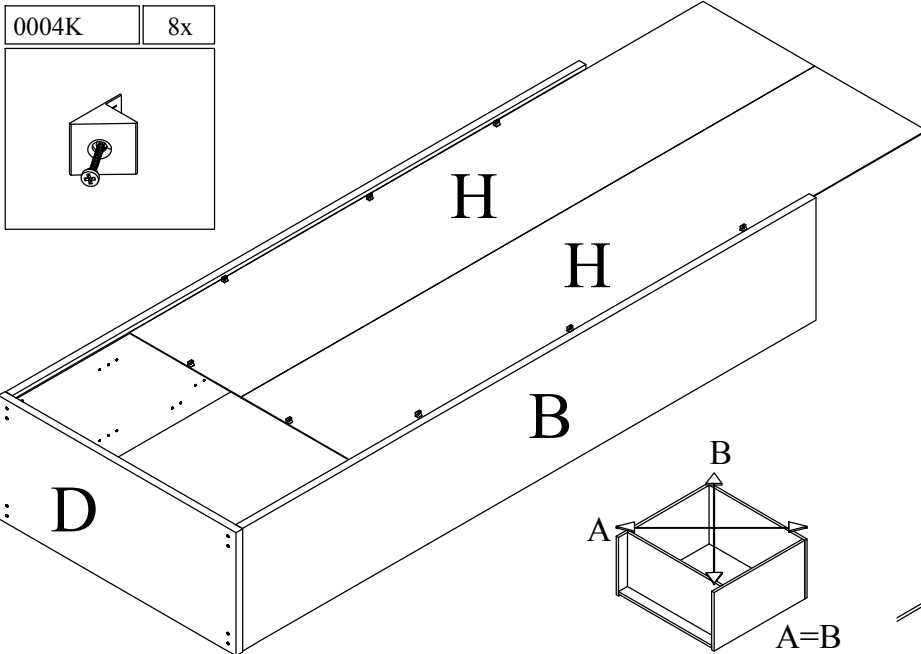
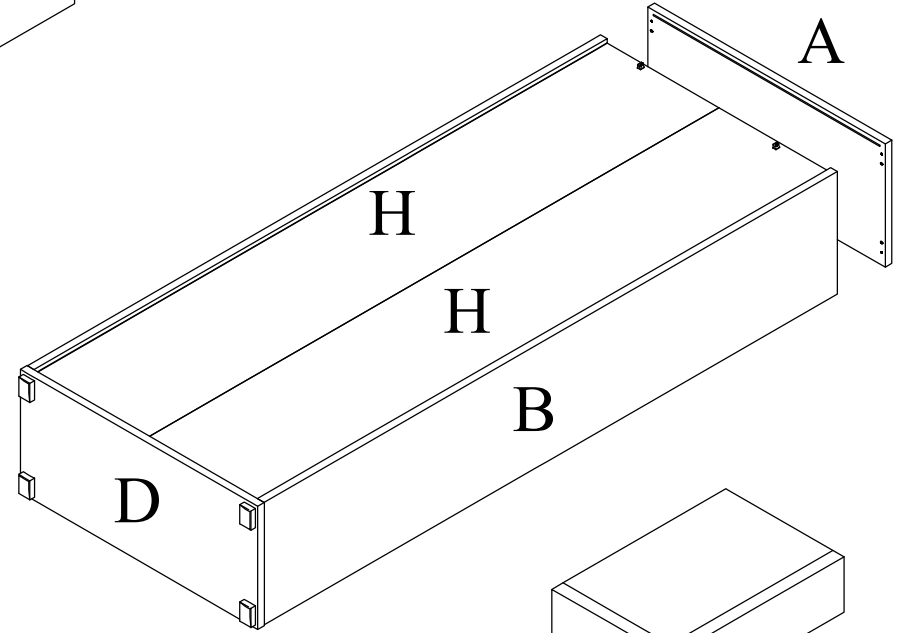
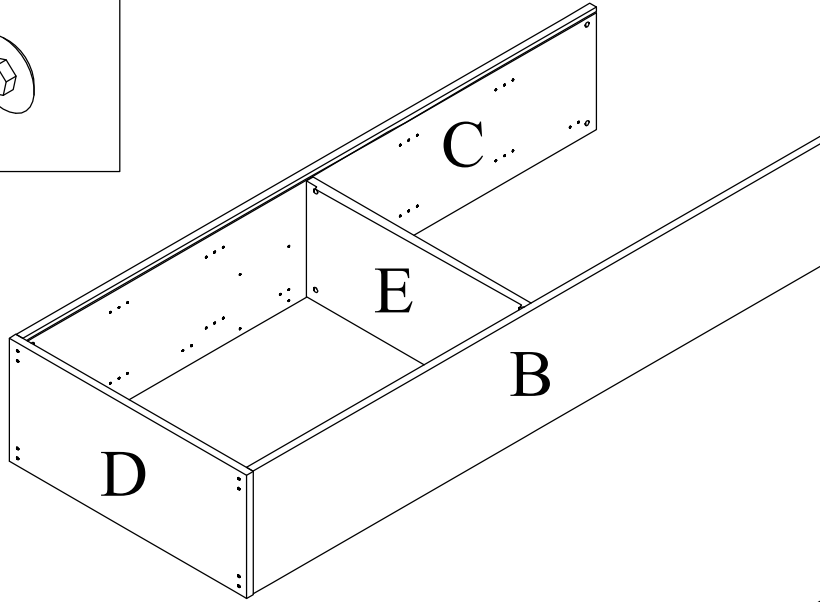
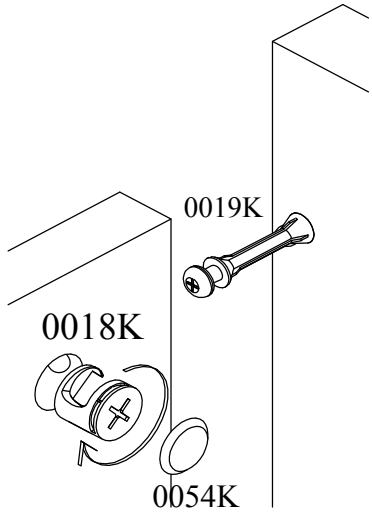

4.)

0009K

16x

