

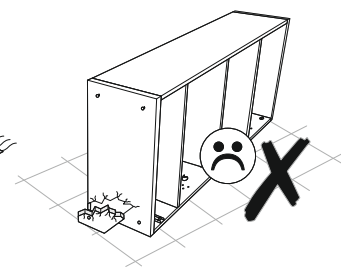

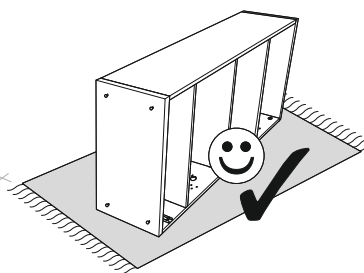

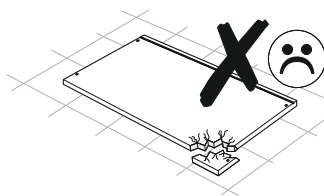

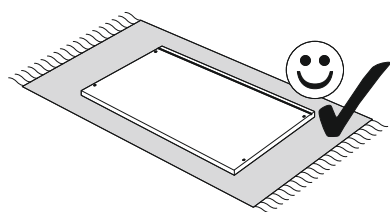

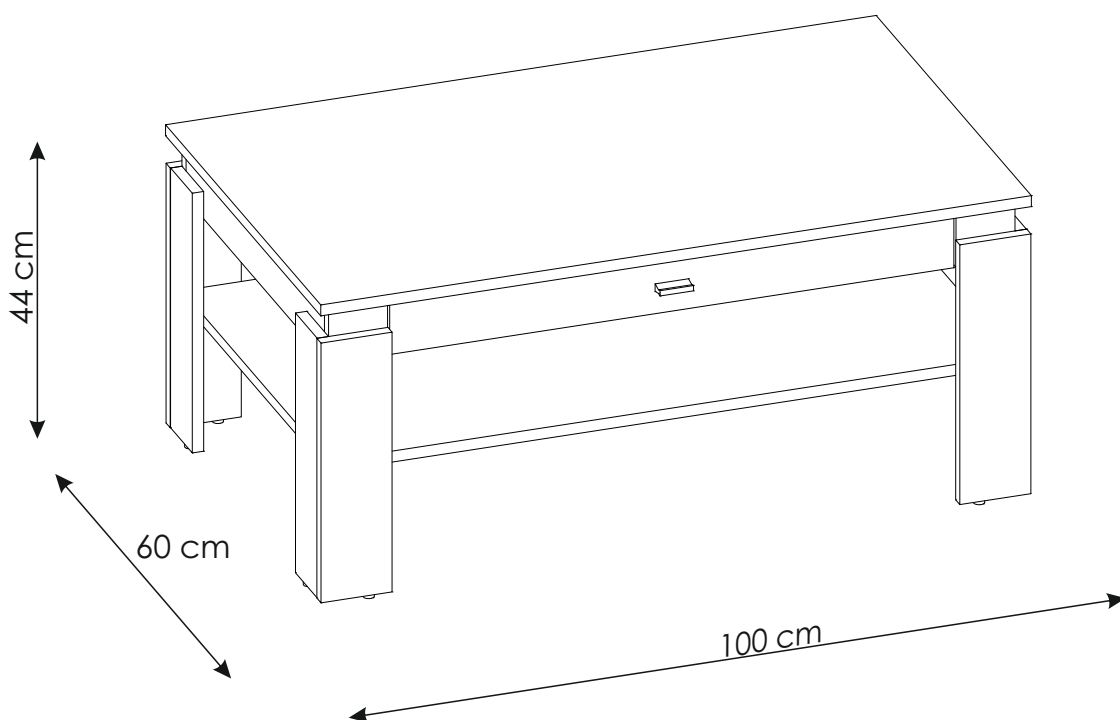
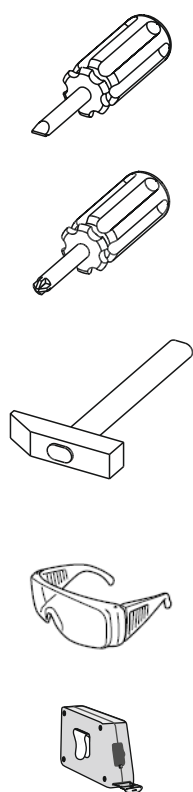
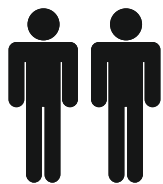



COFFE COFT04

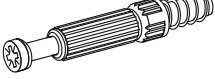
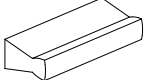

COFFE COFT04

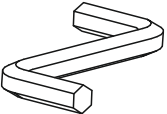
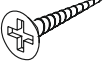
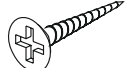
MM

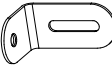
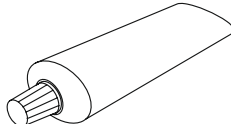
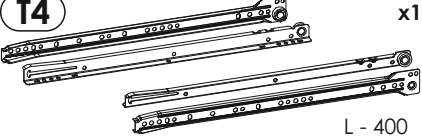
A0 8 x 24 mm x16 	A1 8 x 35 mm x24 	C2 5 x 13 mm x4 
E0 x23 	E1 15 x 12 mm x23 	F1 6 x 34 mm x23 
H1 x1 	I4 3,5 x 27 mm x2 	I11 4 x 30 mm x8 
J10 3,5 x 40 mm x5 	M x1 	N1 3 X 16 mm x10 
N2 3,5 X 16 mm x14 	O2 x8 	Q x7 
S x1 	T4 x1  <p>L - 400</p>	

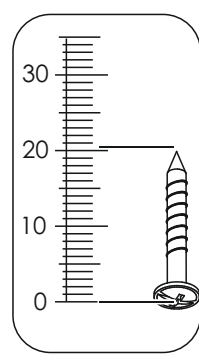
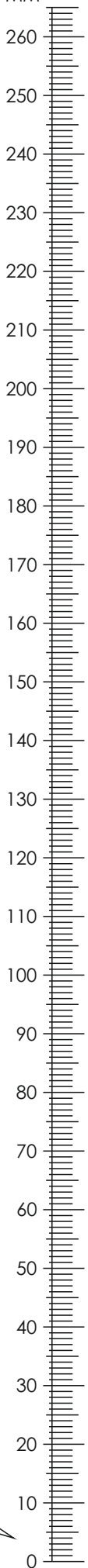

COFFE COFT04

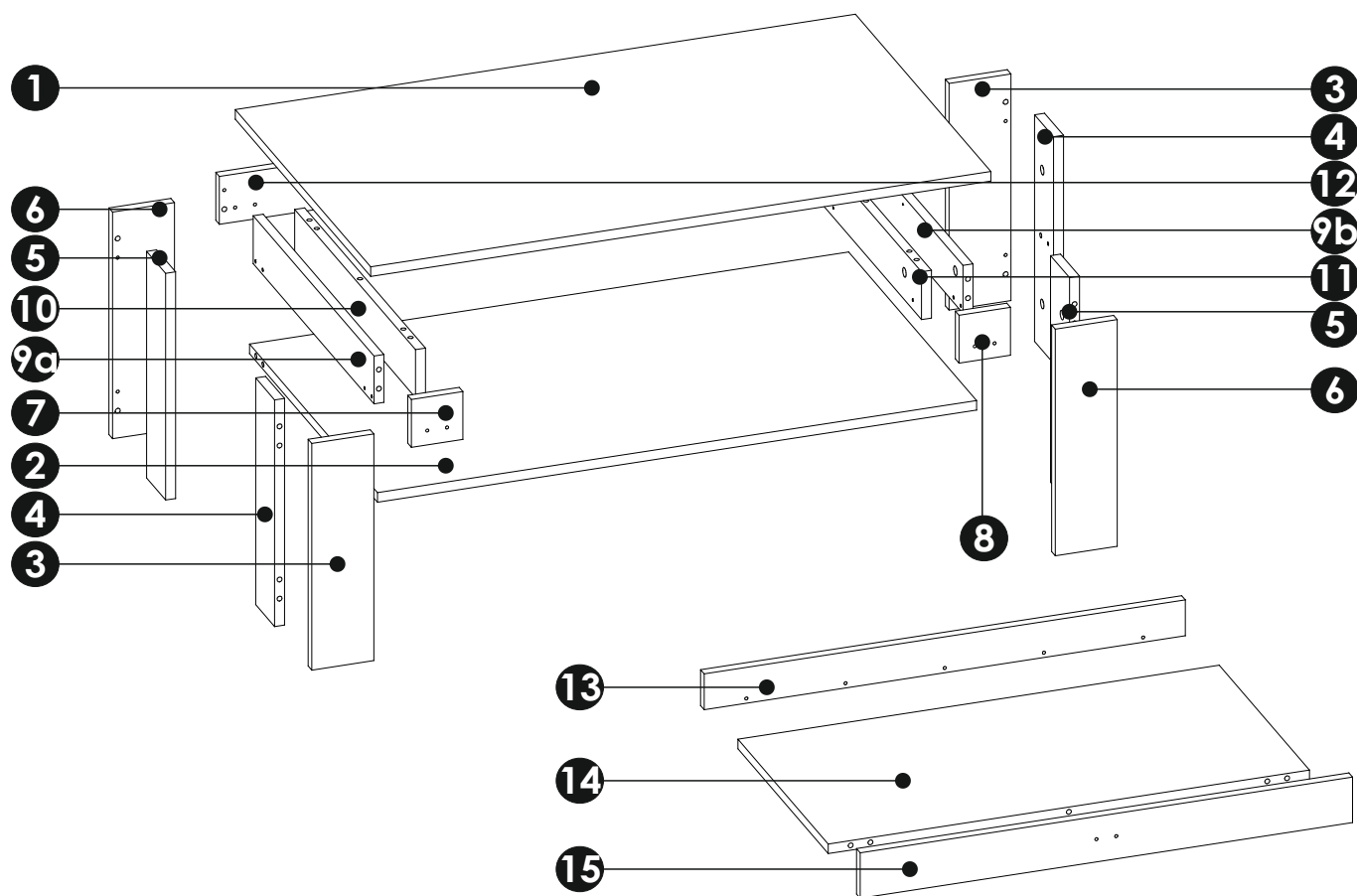
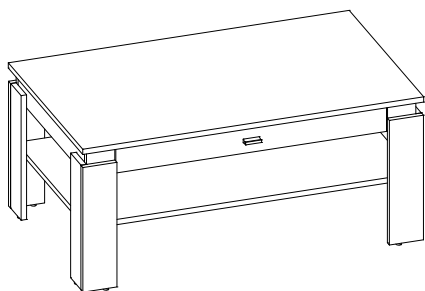

1	1000	600	16	x1	1/1
2	966	567	16	x1	1/1
3	379	100	16	x2	1/1
4	379	84	16	x2	1/1
5	379	84	16	x2	1/1

6	379	100	16	x2	1/1
7	83	80	16	x1	1/1
8	83	80	16	x1	1/1
9a	535	80	16	x2	1/1
9b	535	80	16	x2	1/1

10	535	80	16	x1	1/1
11	535	80	16	x1	1/1
12	966	80	16	x1	1/1
13	776	60	16	x1	1/1
14	776	400	16	x1	1/1
15	794	74	16	x1	1/1

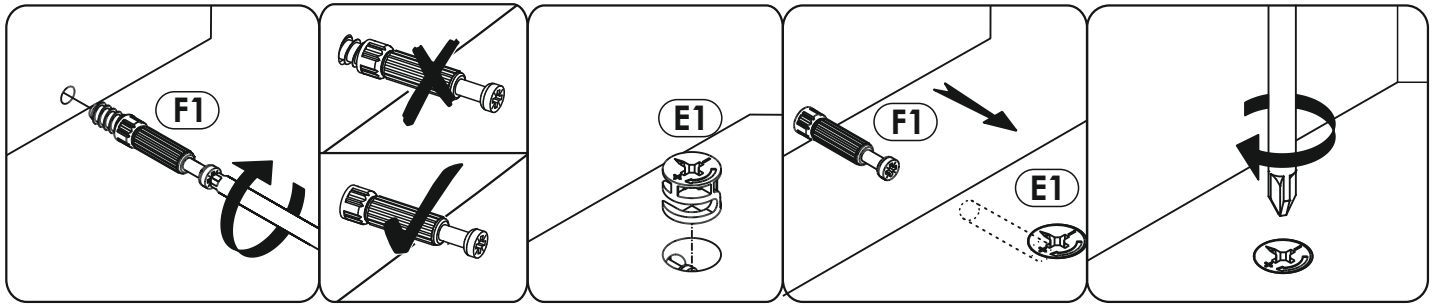

1 ▶

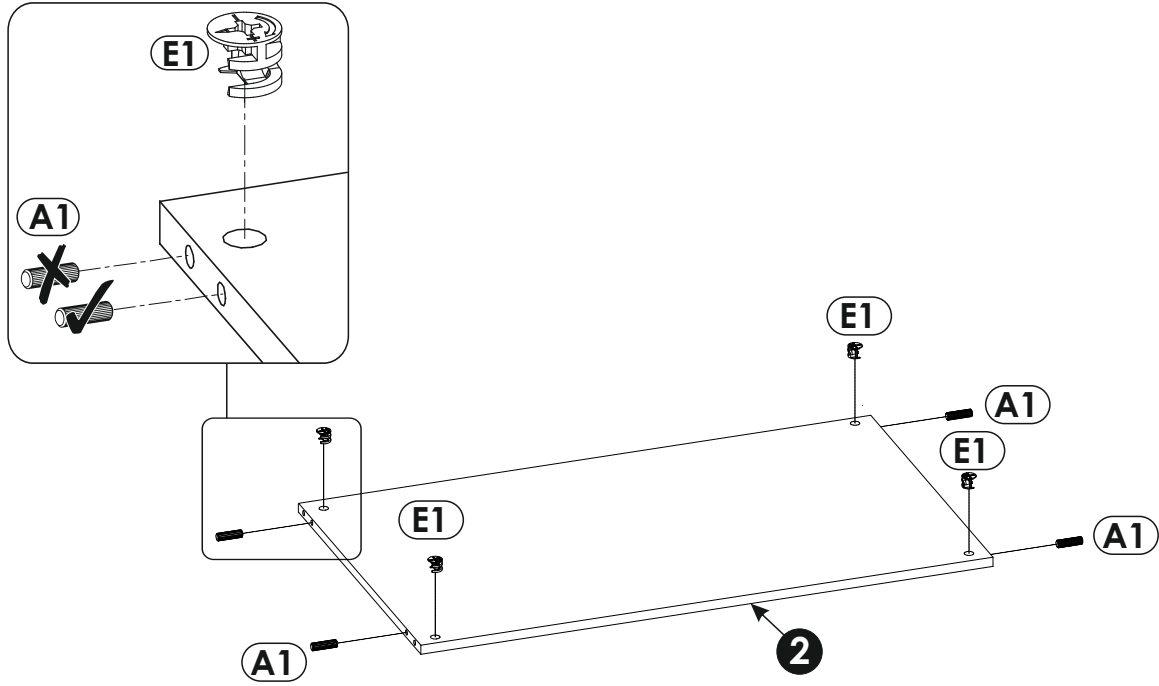

2 ▶

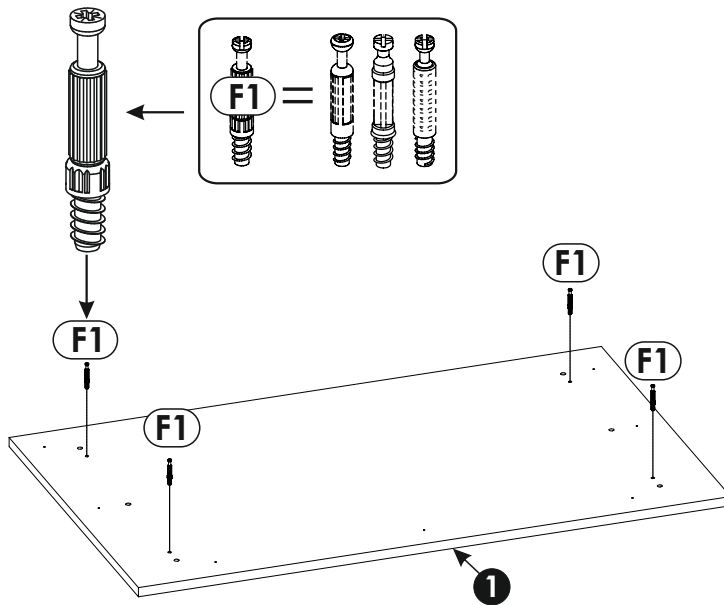

3 ▶

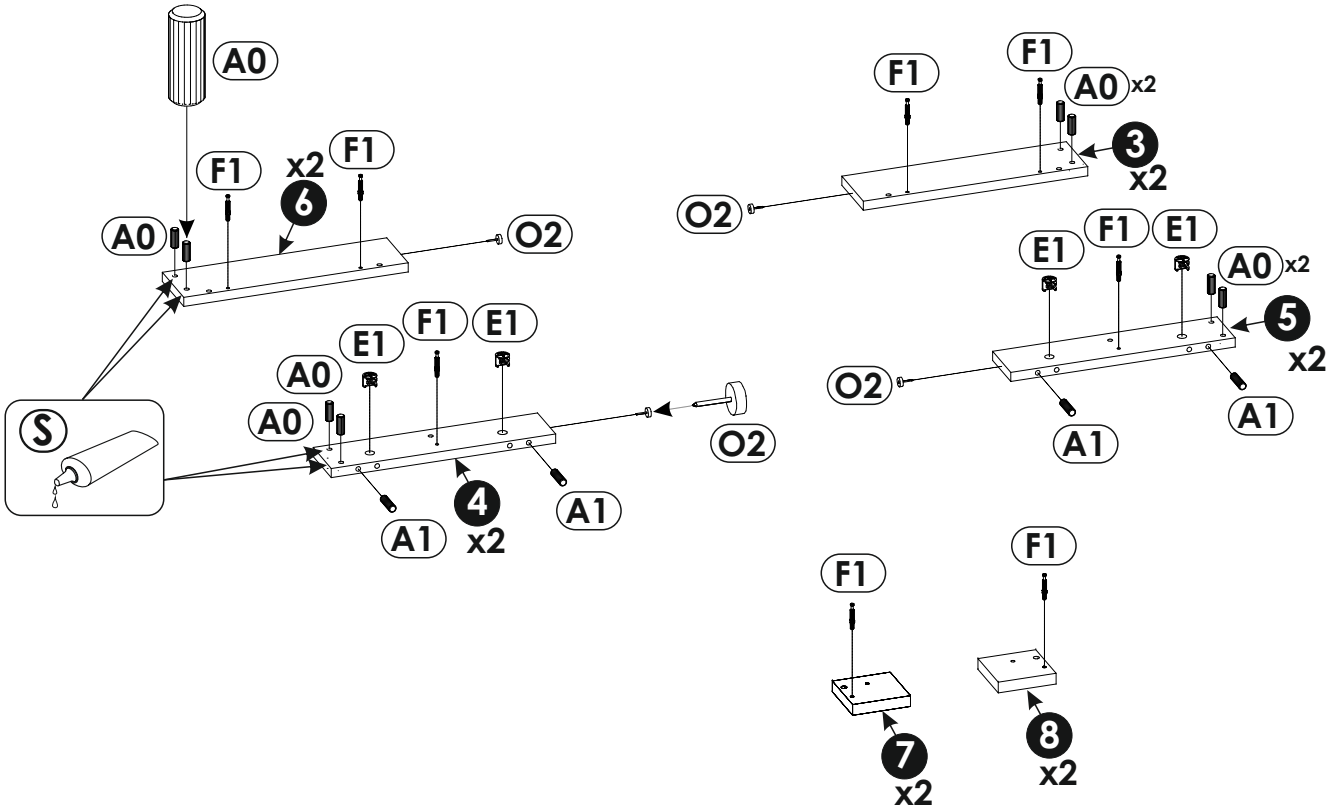

4 ▶

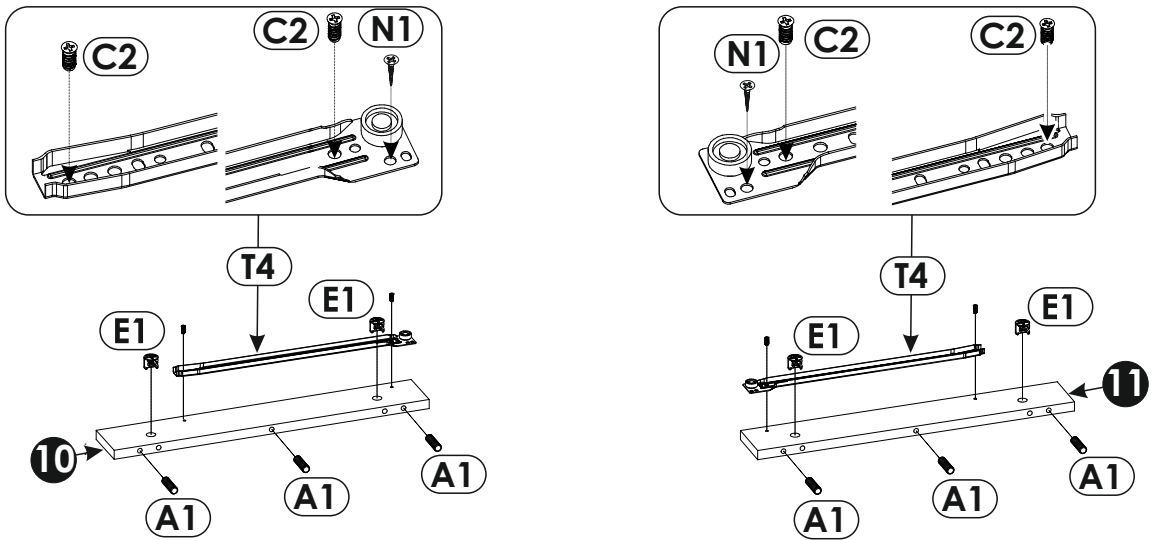

5 ▶

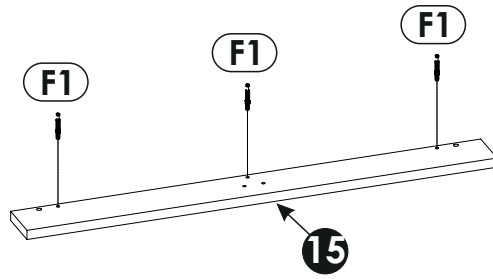
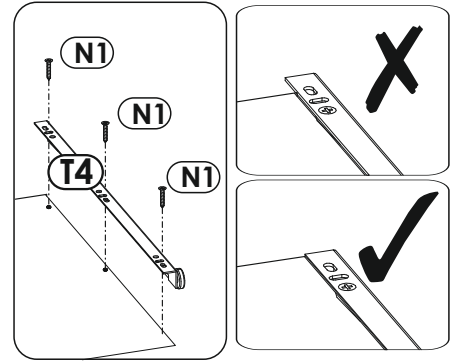
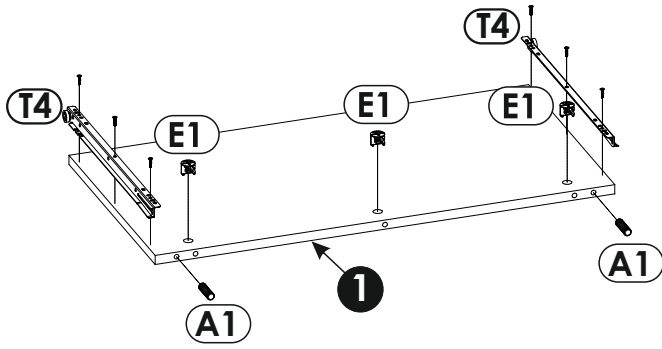

6 ▶

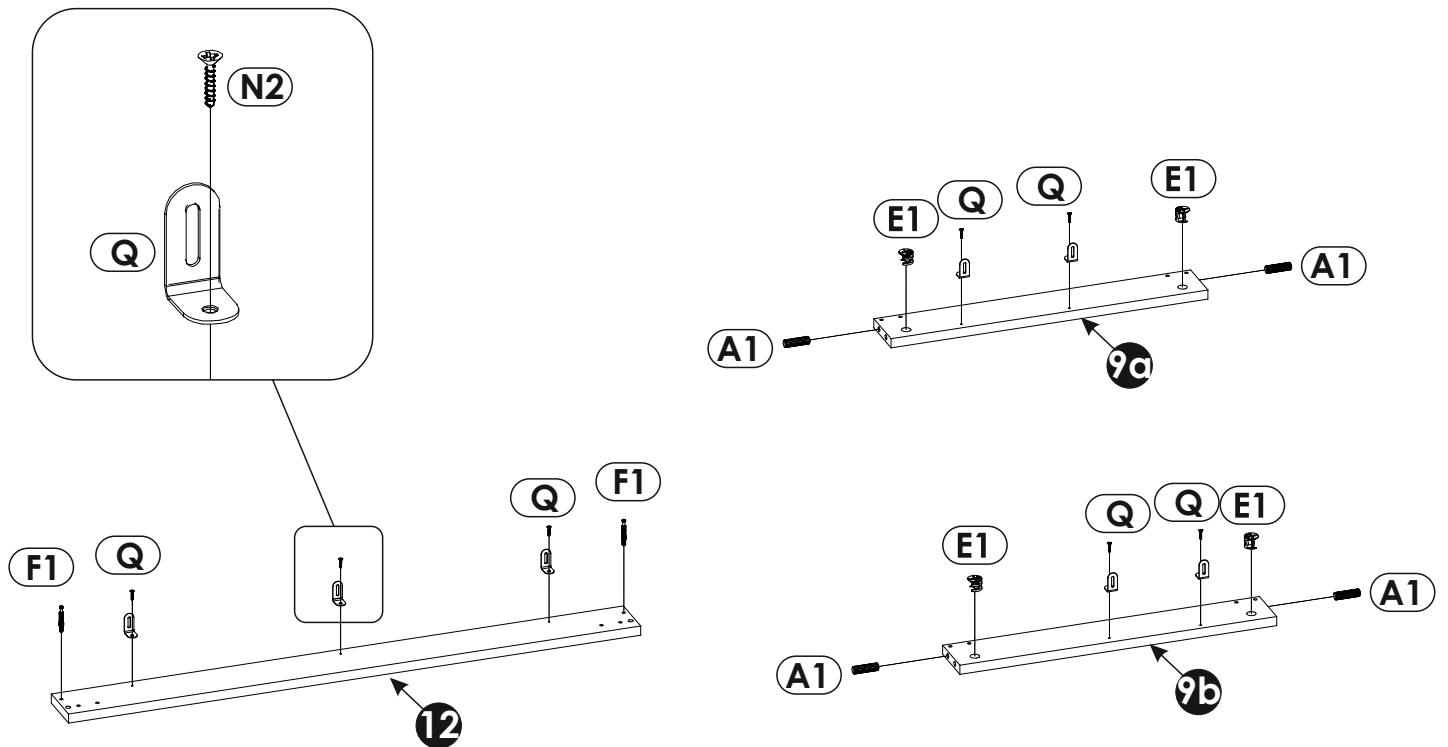

7 ▶

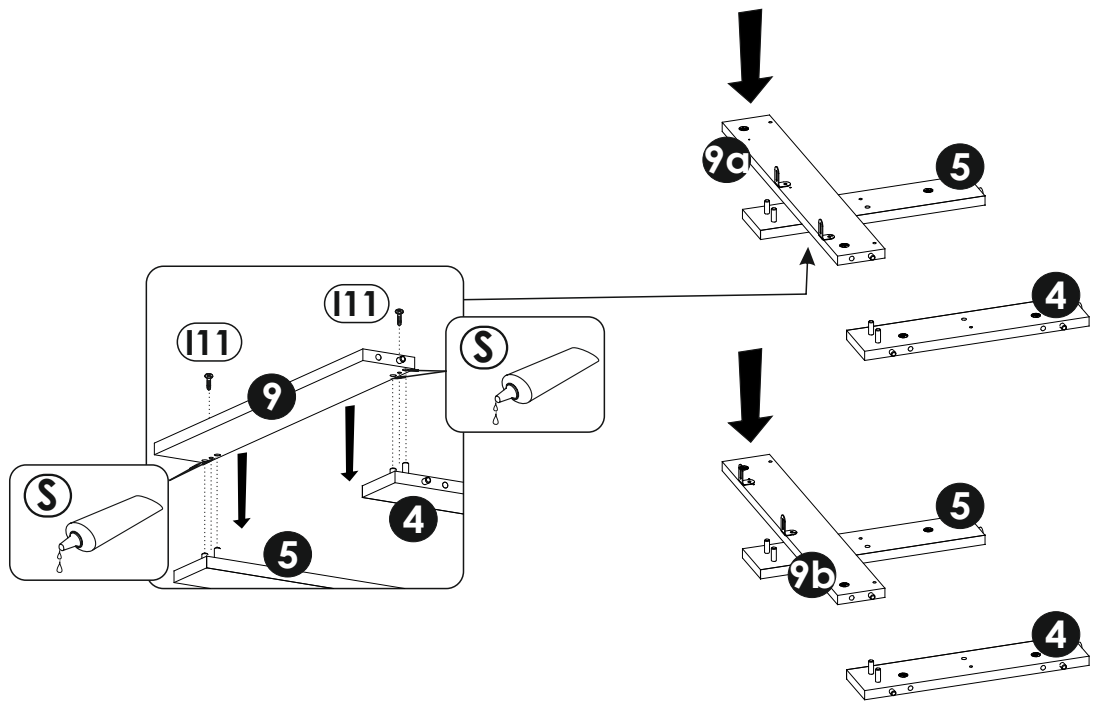

8 ▶

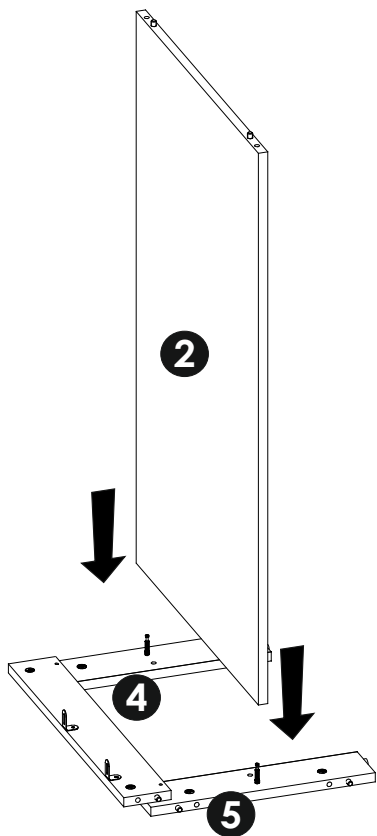

9 ▶

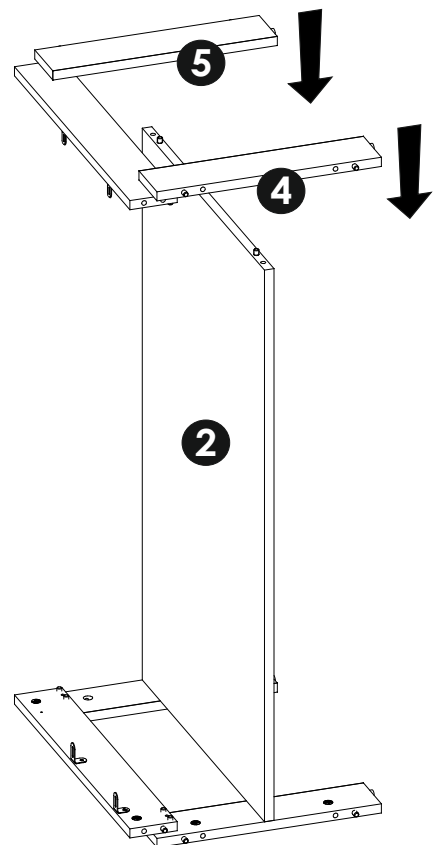
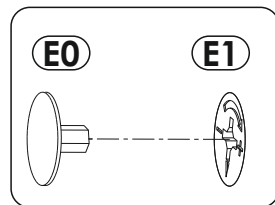

10 ▶

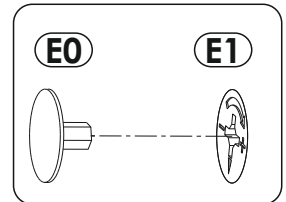
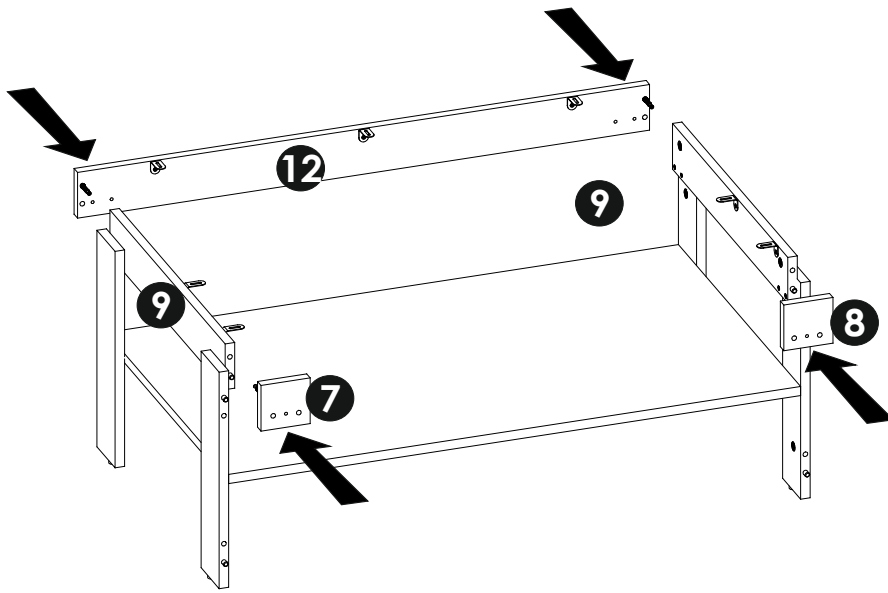

11 ▶

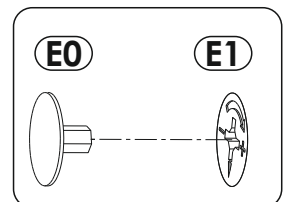
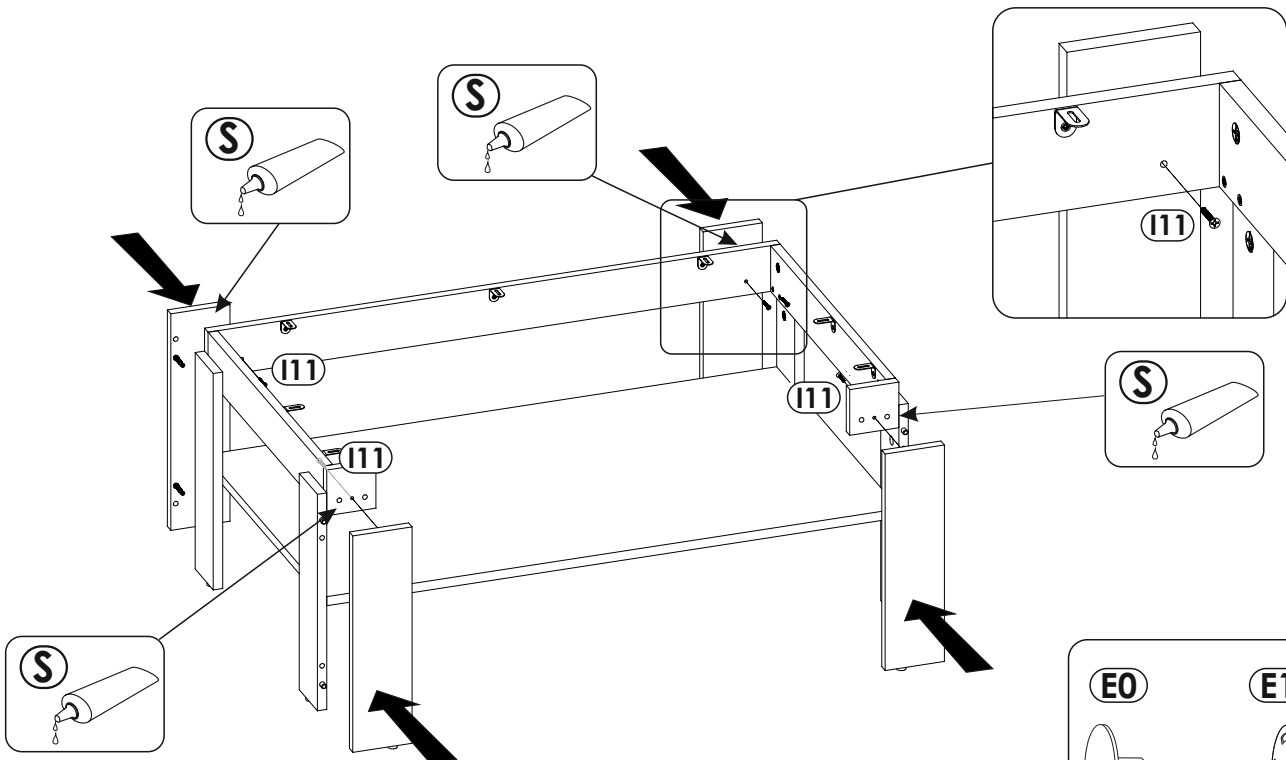

11 ▶

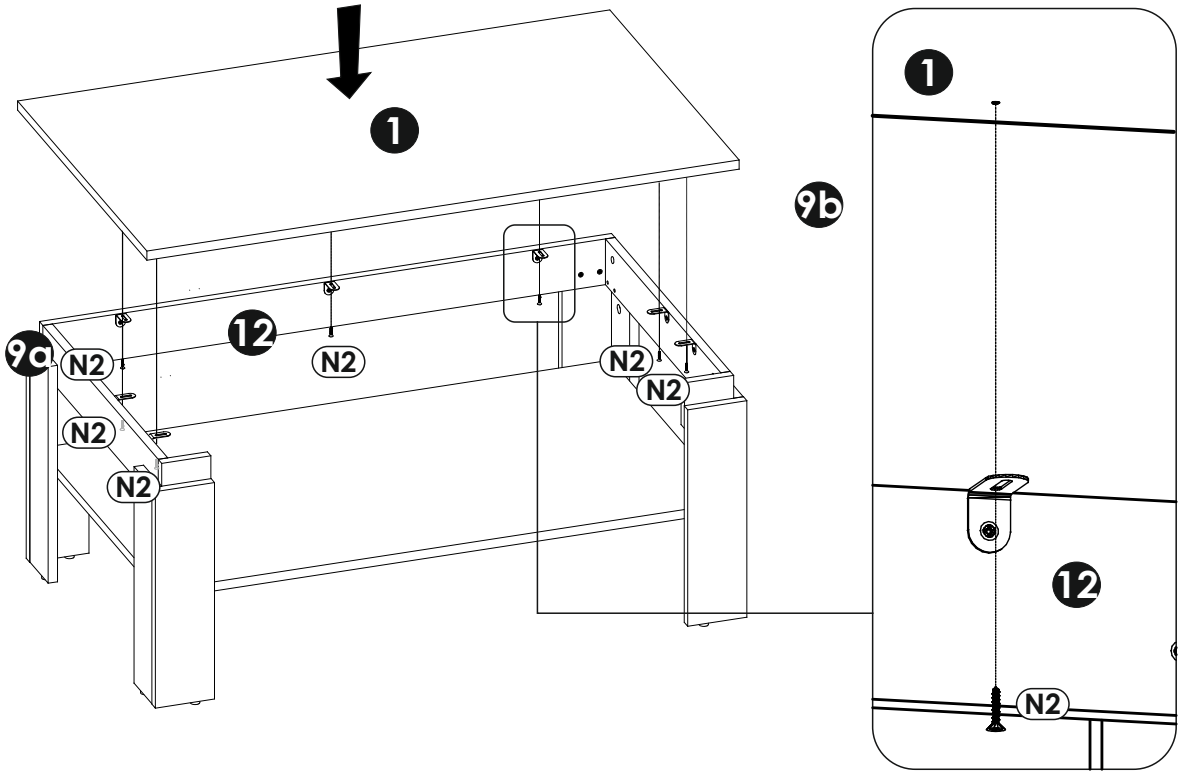

12 ▶

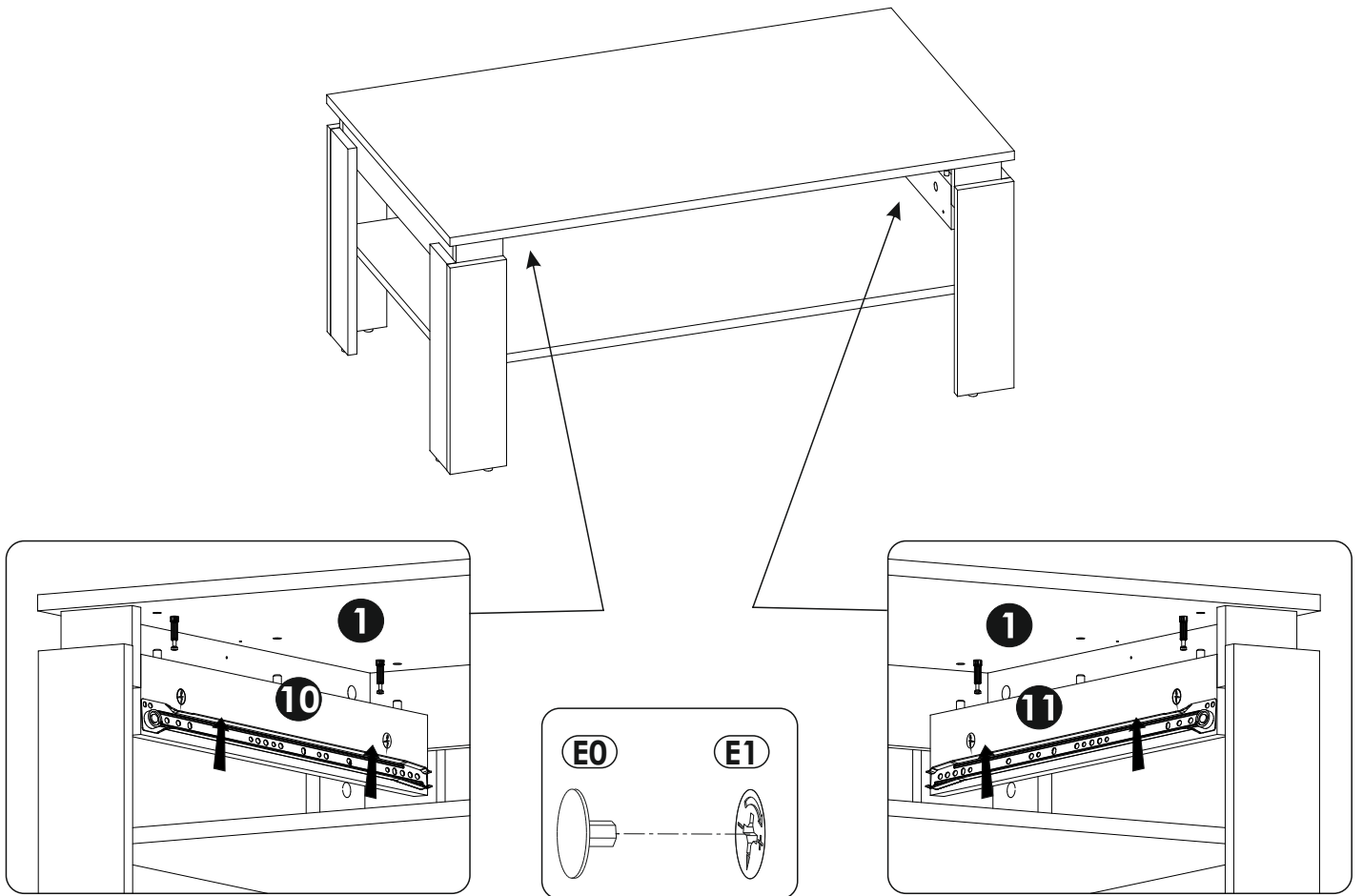

13▶

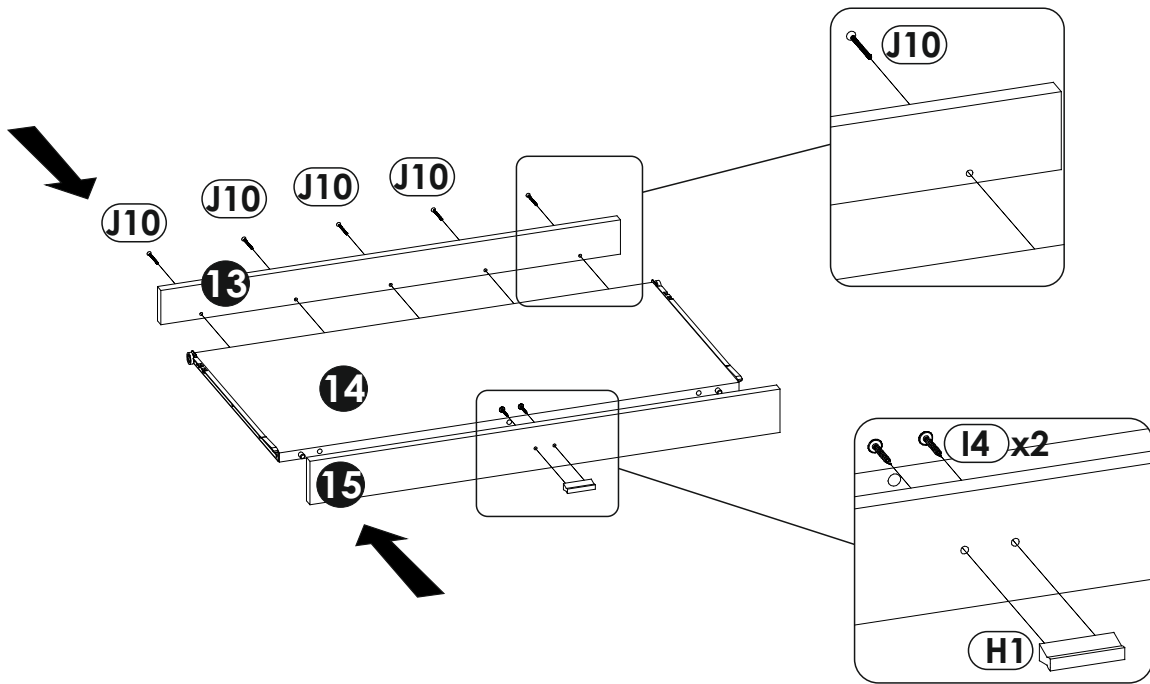

14▶

