



T1 Vyplňte prosím!

Meno

Ulica

PSC Město

Tel.

T2 Vážení zákazníci,
Sme radi, že ste si vybrali výrobok od spoločnosti Pelipal. Ak by sme Vám aj napriek všetkému úsiliu z našej strany nedodali niektoré diely, pošlite prosím tento vyplnený list na

Fax : +49 3443/434354
E-Mail: weissenfels.ersatzteile@pelipal.de

Pre vybavovanie sťažností je absolútne nevyhnutné uviesť číslo tovaru skrinky, ktoré možno vidieť na štítku a na trhu, kde bol nábytok zakúpený. Okrem toho zadajte nižšie uvedené požadované množstvo. Bavte sa s vaším novým kúpeľňovým nábytkom! Váš tím Pelipal

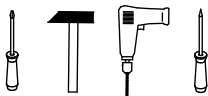

T3 Pre montáž je potrebný 2 osôb.

T4 Doba montáže 3 hodiny

12 x a EXZENTER-000015	kus	12 x b DUEB-SMD-000005	kus	12 x c TRAE-001-000020	kus	5 x d TBD-35-115X00	kus	5 x e ZPL-003X000	kus	
12 x f SCH-KA-063X011	kus	14 x g SCH-SPA-035X015	kus	1 x h AUF-001-000080	kus	1 x j AUF-001-000090	kus	2 x k AUF-001-000020	kus	
12 x l klinec-025X001	kus	2 x m dvere-DAEM-000010	kus	2 x n dvere-ADA-000010	kus	4 x o úchytka	kus	8 x p screw	kus	
4 x q ADK-AL1-005X008	kus	2 x MB01 KA-MB-0180			kus	2 x MB02 KA-MB-0190			kus	
2 x MB03 KA-MB-0160			kus	2 x MB04 KA-MB-0170			kus	4 x MB05 KA-MB-0100		
16 x MB06 SCH-SPA-040X016	kus	2 x MB07 KA-MB-0020	kus	2 x MB08 KA-MB-0030	kus	4 x MB09 KA-MB-0015	kus	8 x MB010 SCH-SON-040X015	kus	

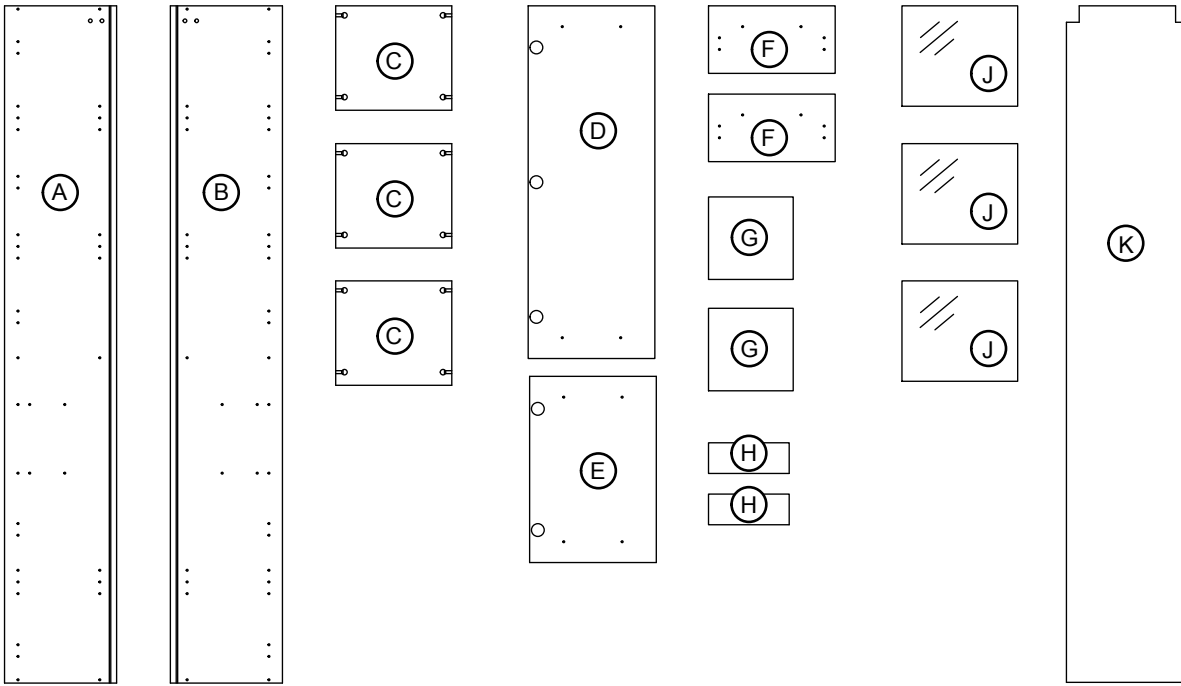

1.

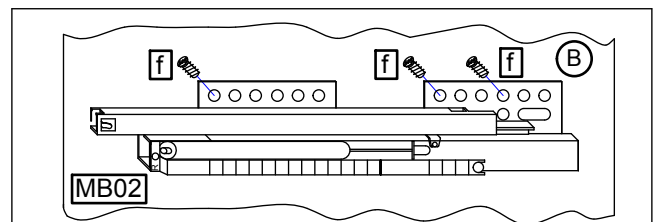
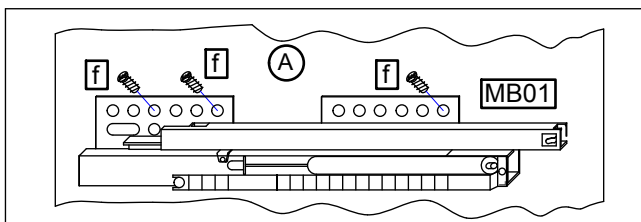
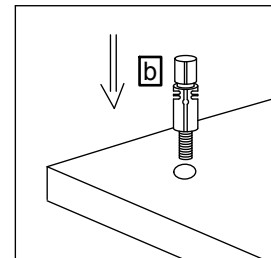
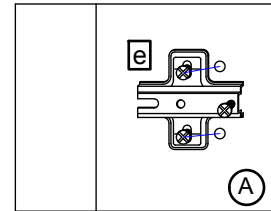
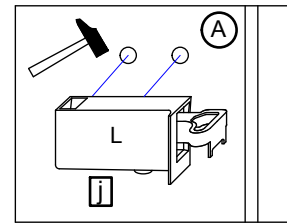
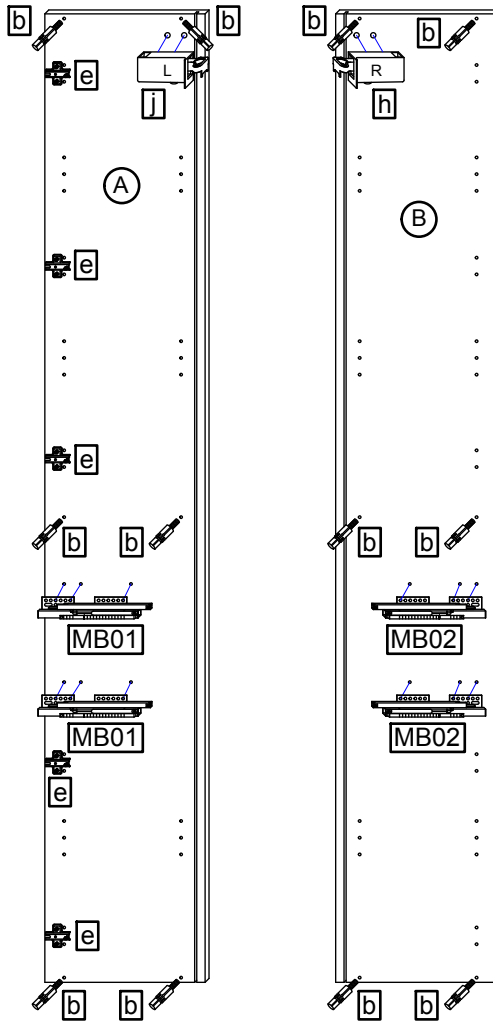
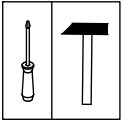

2.

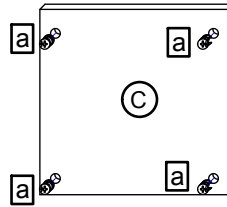
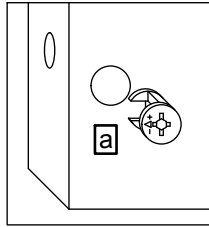

3.

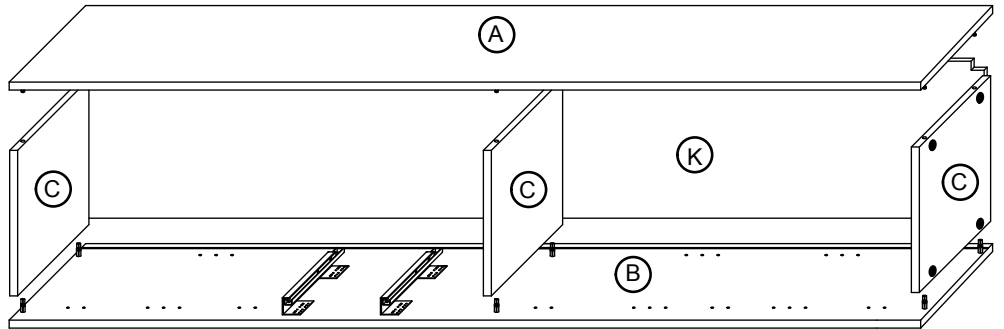
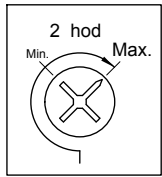
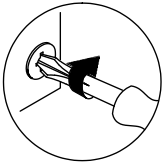
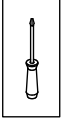

4.

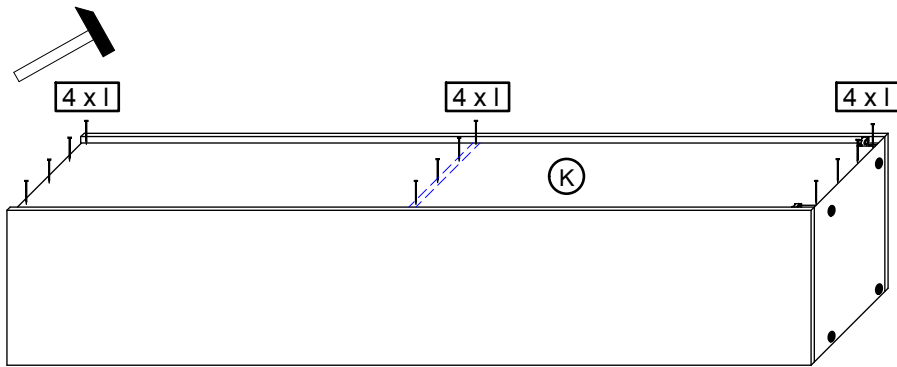
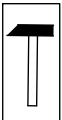

5.

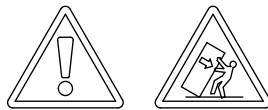
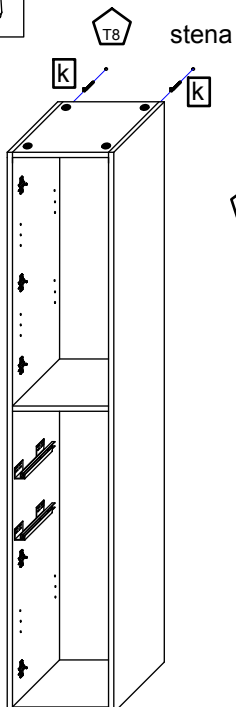
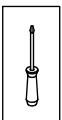

T9 Nechajte skrinku namontovať len kvalifikovaným osobám s montážnym materiálom vhodným pre stenu.

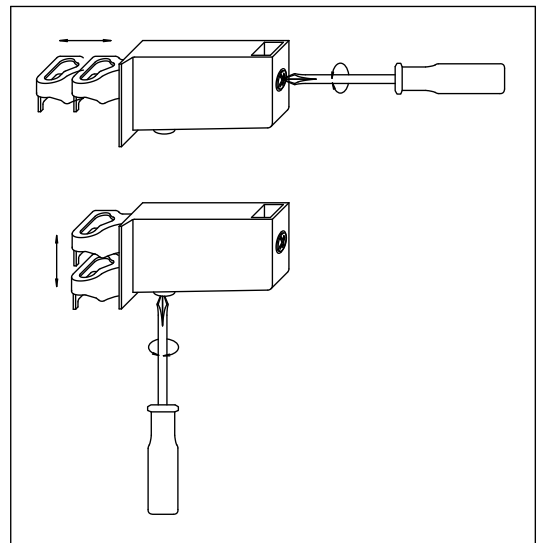
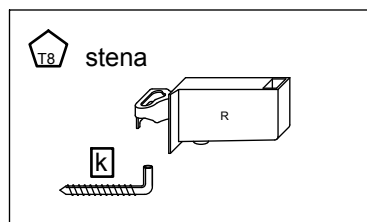

6.

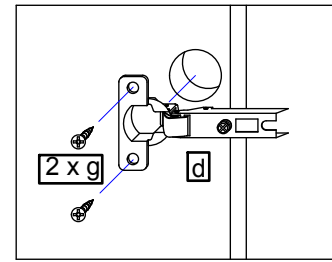
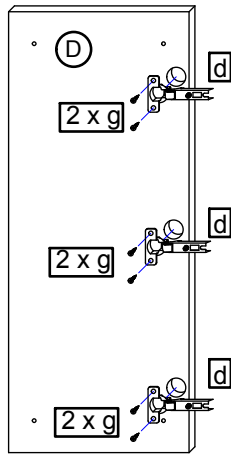
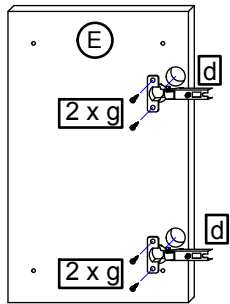
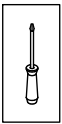

7.

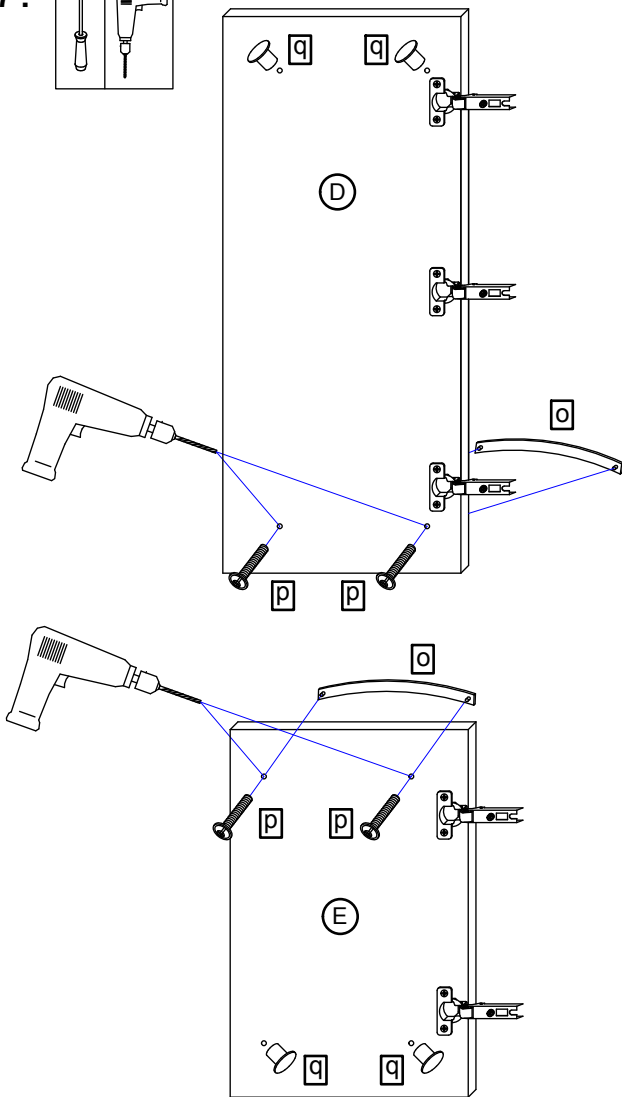
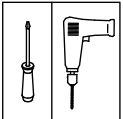

7.1

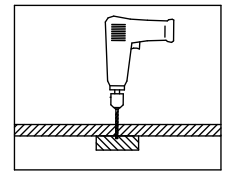
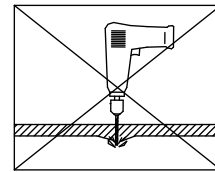

7.2

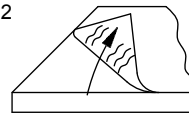

U front s vysokým leskom
 najskôr odstráňte ochrannú fóliu
 a potom nainštalujte rukoväť!

7.3

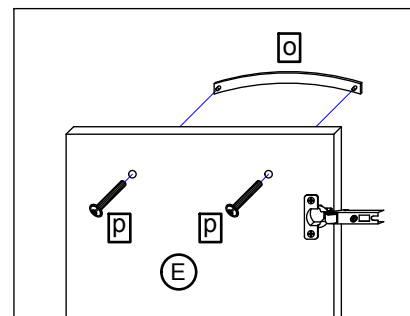
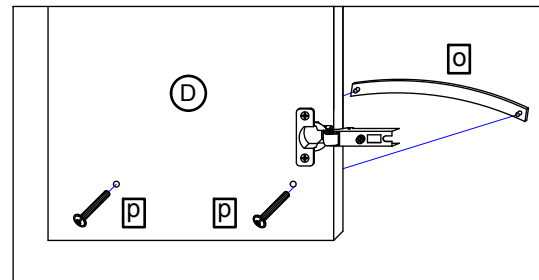

8.

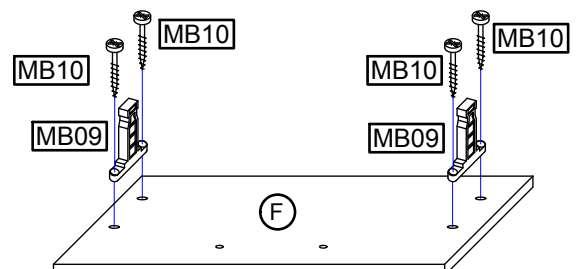
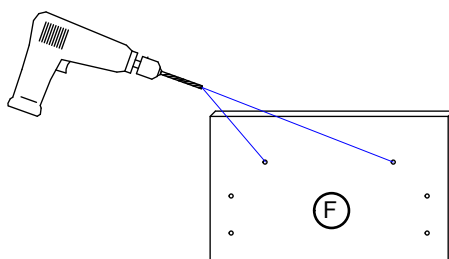
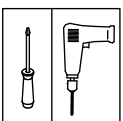

9.

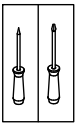

T11

Pri namontovaní dverí zaveďte háčik do závesu, otvorte ho až na doraz a potom ho pevne priskrutkujte.

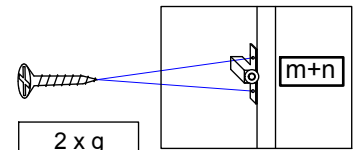
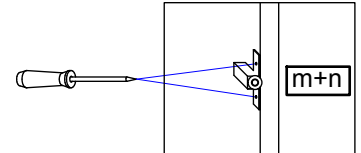
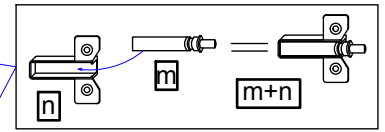
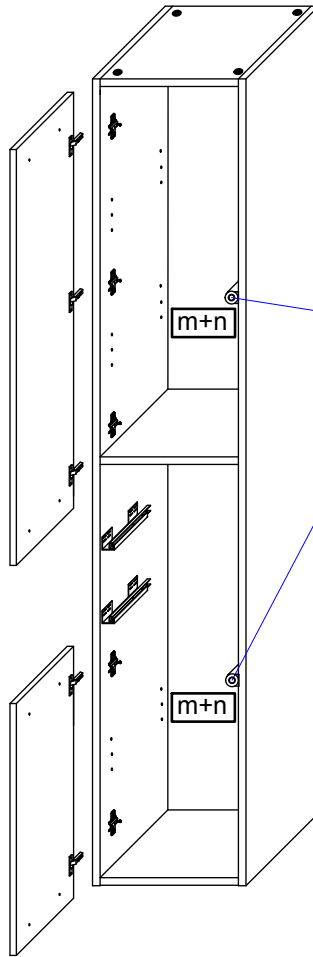
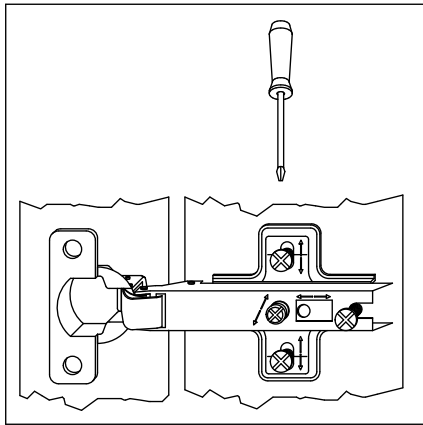
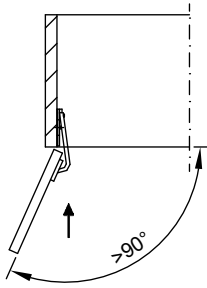

2 x g
(3,5x15)

10.

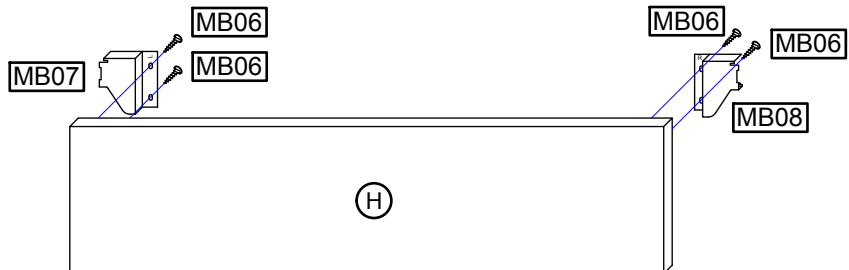
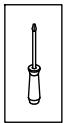

11.

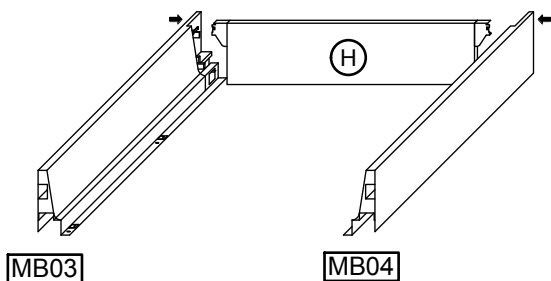

12.

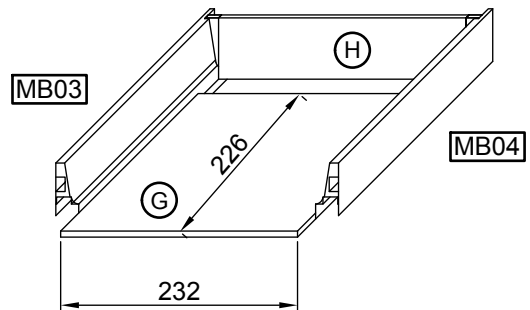

T5

Vystrihnite štítok, ktorý je umiestnený vpravo dole, a nalepte ho na zadnú stranu (nie páskou).



PELIPAL GmbH
Industriestrasse 2

33189 Schlangen
Germany

13.

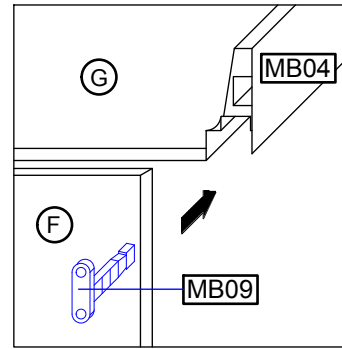
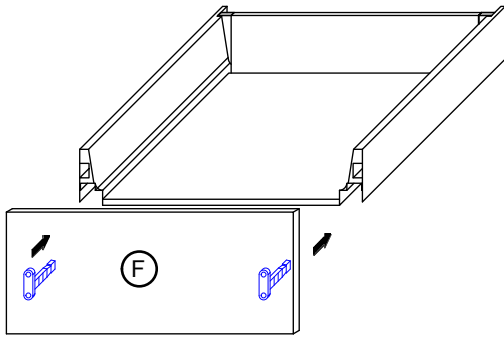

14.

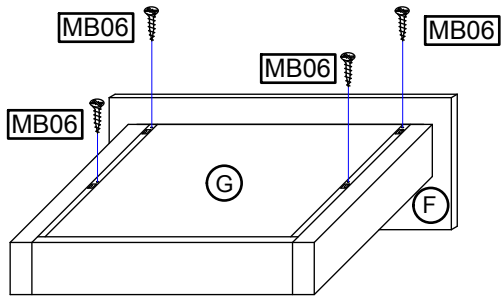
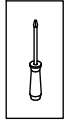

15.

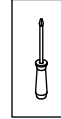

U front s vysokým leskom najskôr odstráňte ochrannú fóliu a potom nainštalujte rukoväť!

15.1

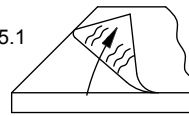

15.2

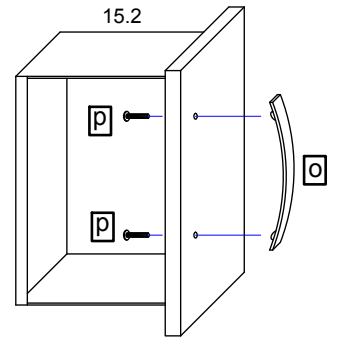

16.

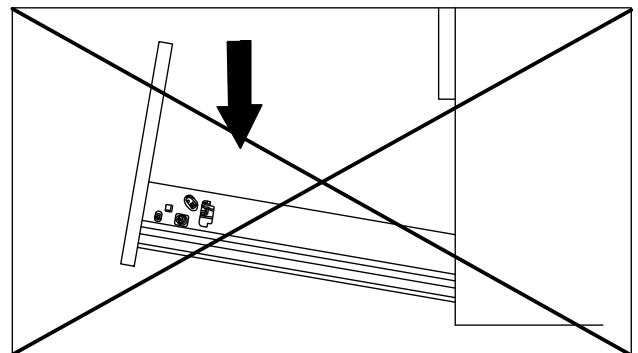
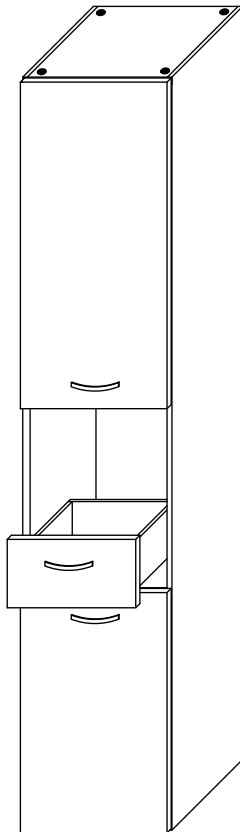

16.1

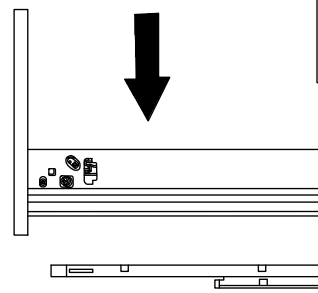

16.2

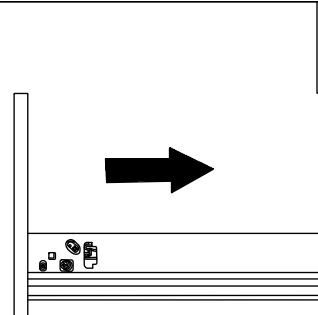

17.

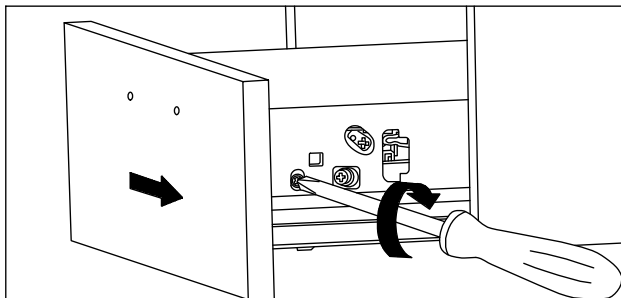
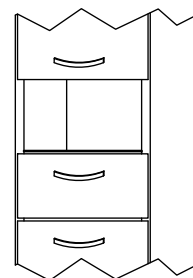
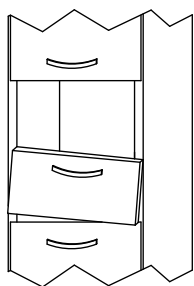
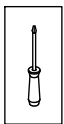

17.1

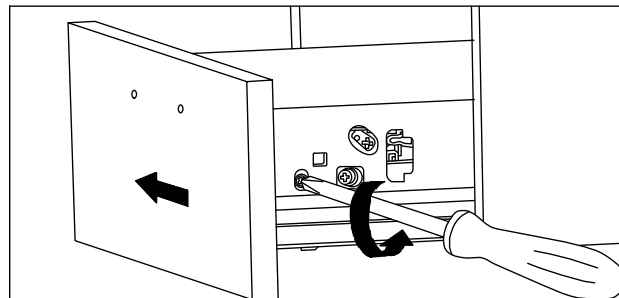

17.2



17.3



17.4

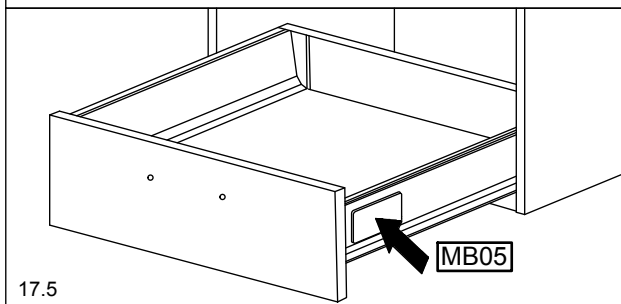

17.5

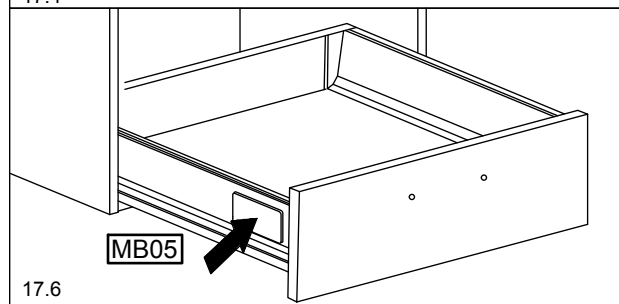

17.6

18.

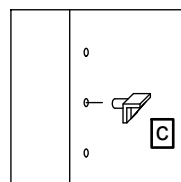
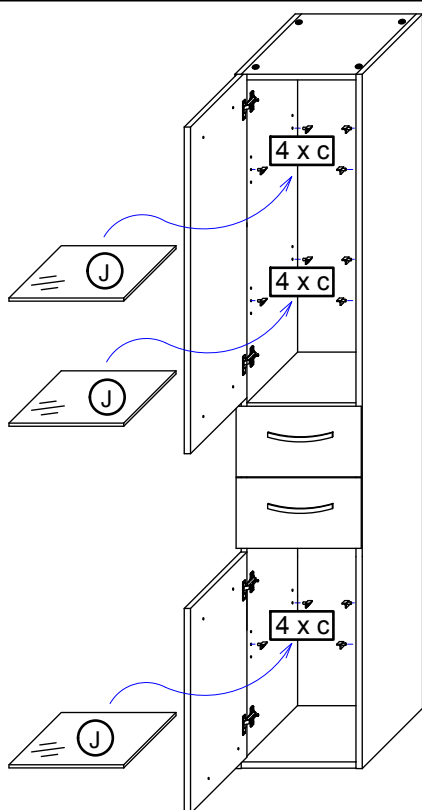

Nábytok prosím vyčistíte iba vlhkou handričkou.