

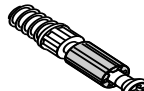

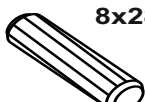







 12x T02	 12x T01	 8x28 16x D01	 1x F01	 1x F11	 14x R01
 12x E01	 5x S01	 1x P01	 4x13 2x W07	 3,5x15 12x W03	 1x E02
 6x Z04	 KR-15 6x Z01	 2x U01	 4x25 4x W01		

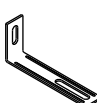
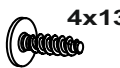
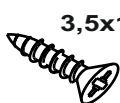

Č.	Rozmer	Ks	COLLI
1A	1453x345x15	1	2/2
2A	1453x345x15	1	2/2
3A	720x352x22	1	1/2
4A	689x323x15	1	1/2
5A	1377x708x2	1	2/2
6	689x80x15	1	1/2
7A	689x296x15	3	1/2
8A	689x296x15	1	1/2
9	1367x341x15	2	2/2

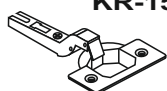
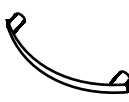

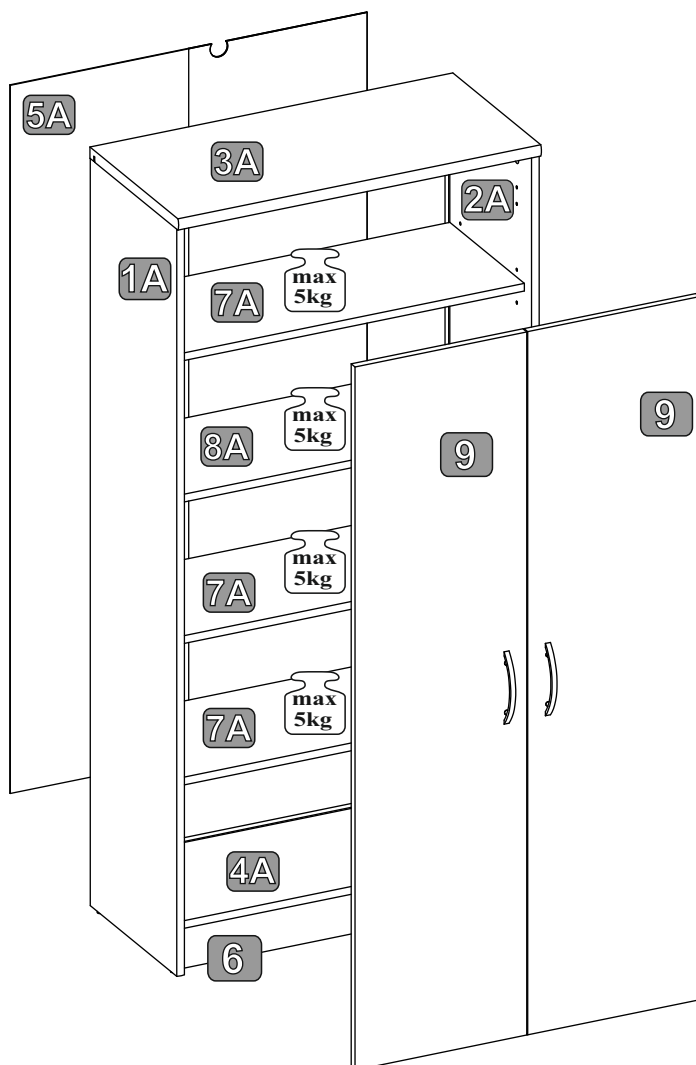
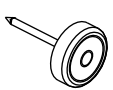
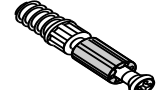
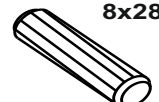
# 1

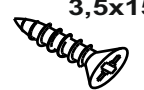
5X		12X		16X		6X		6X		12X	
	S01		T01		D01		Z04		Z01		W03

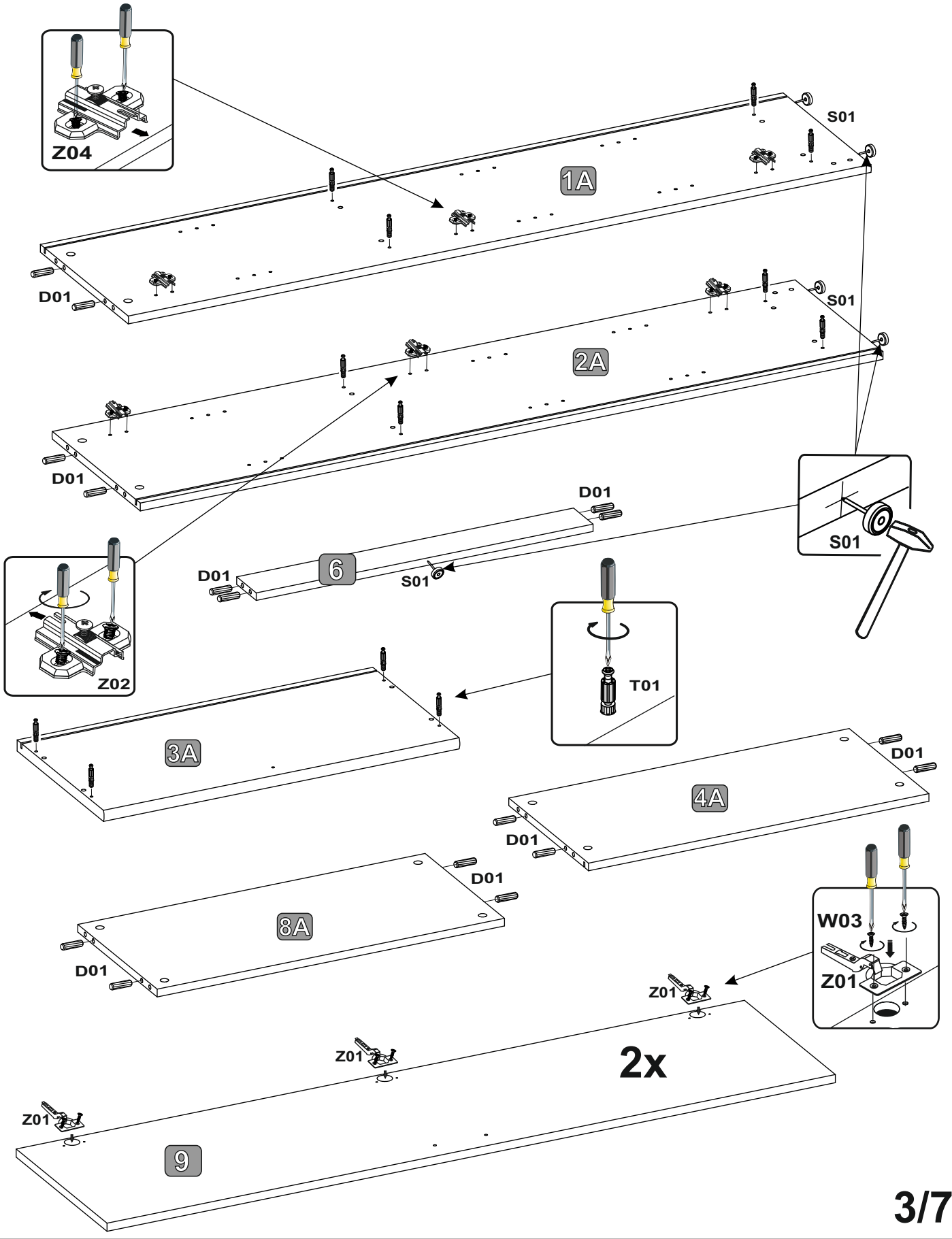

## 2

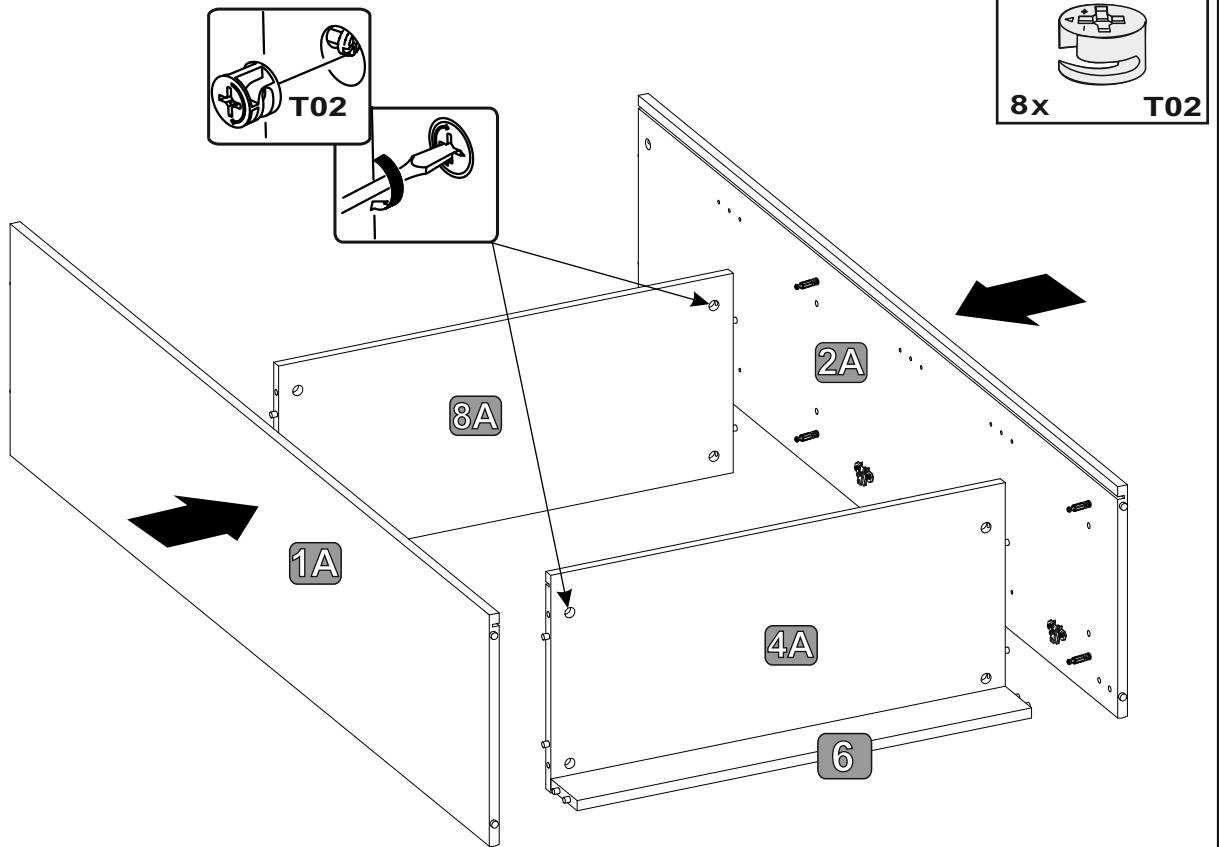

## 3

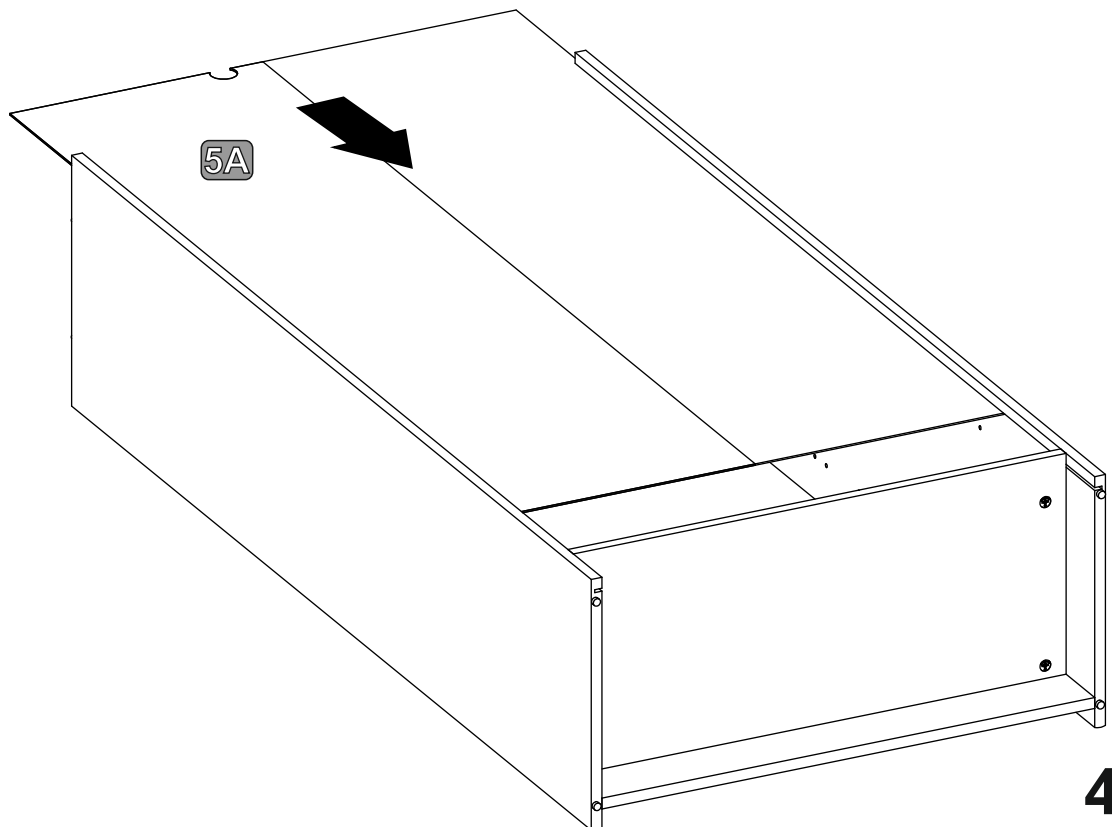

## 4

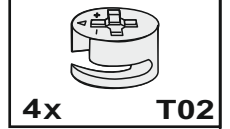
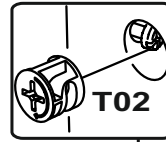
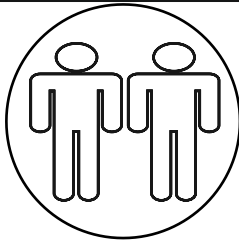

3A

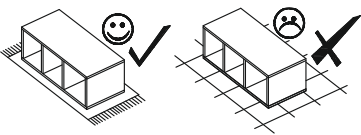
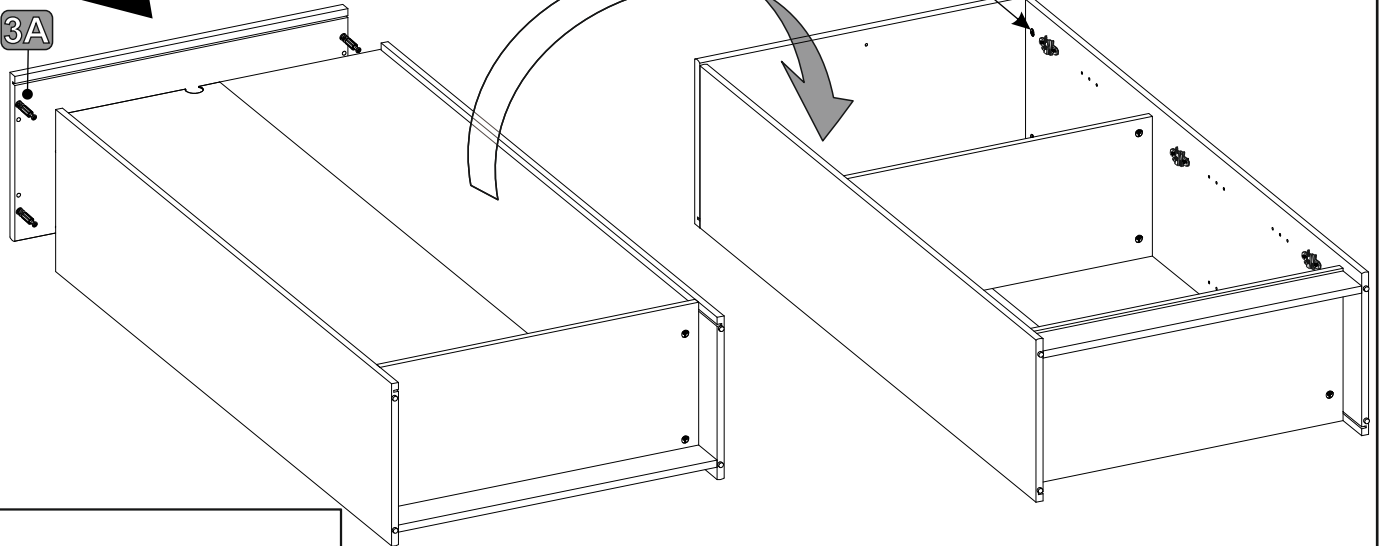





## 5

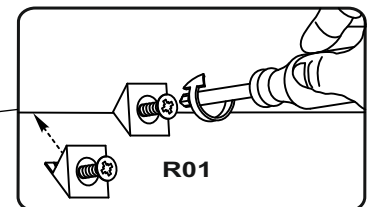
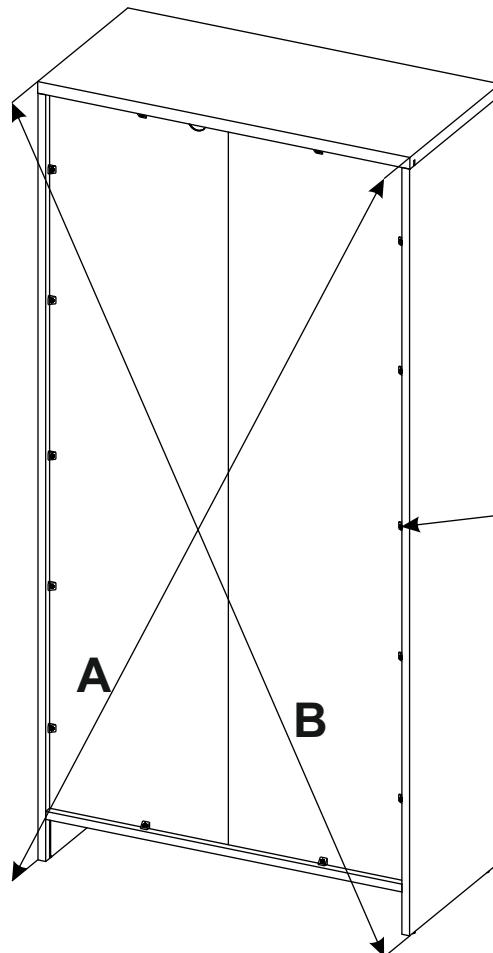



A=B

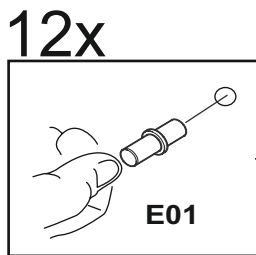
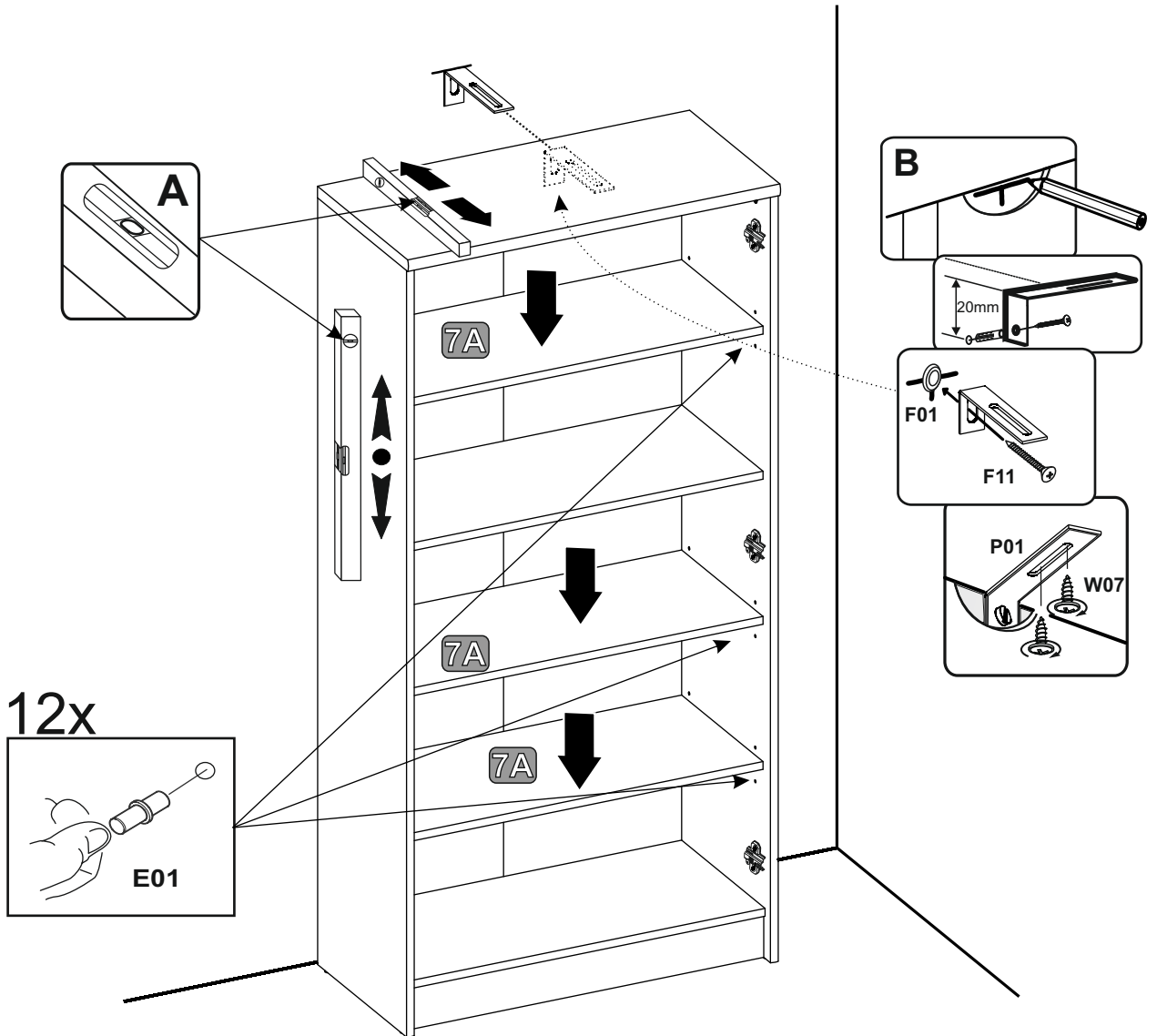

## 6

				
12x E01	2x W07	1x P01	1x F11	1x F01





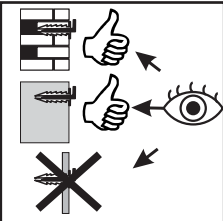

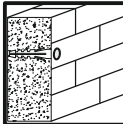

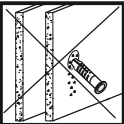

6/7

# 7

