

980756

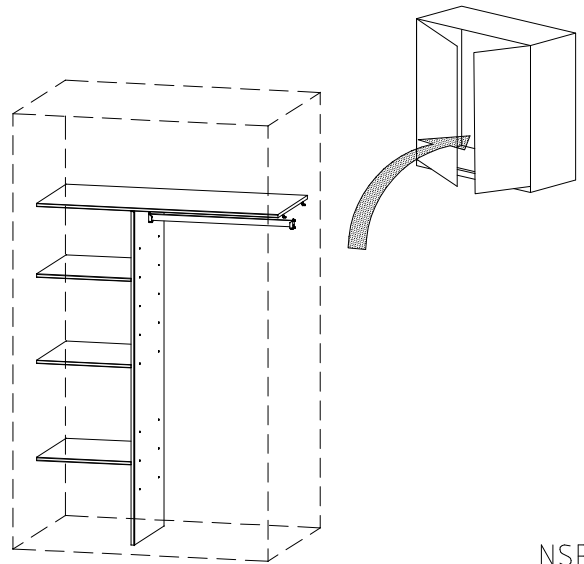

NSP 110

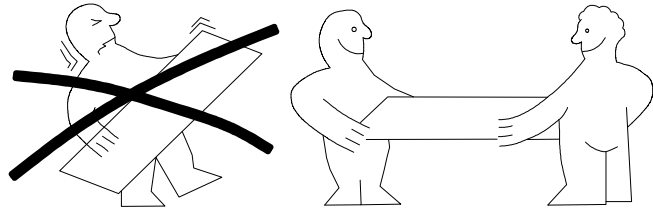
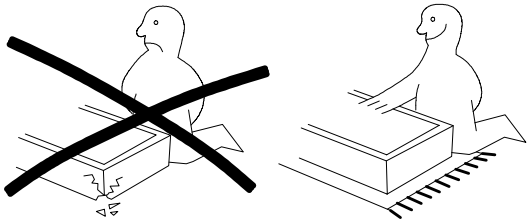
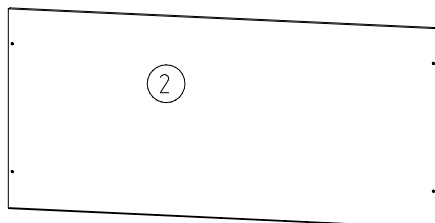
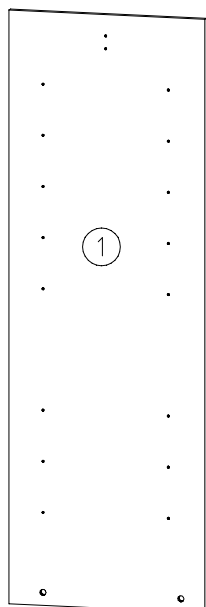
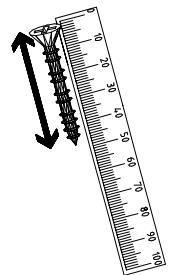
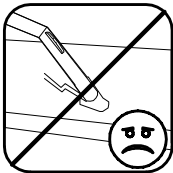
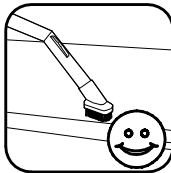
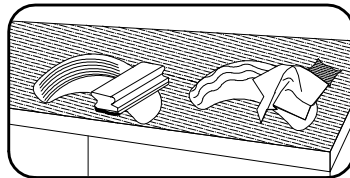
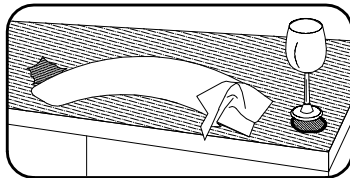
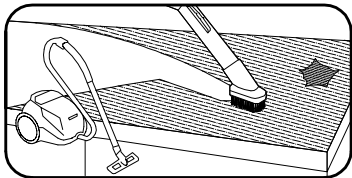
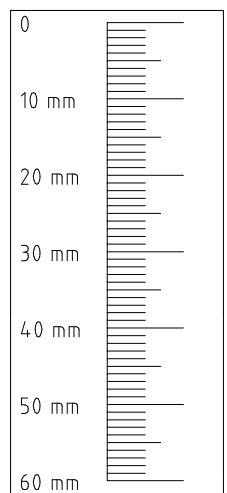
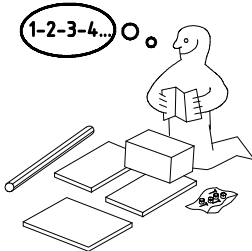
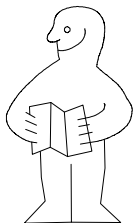

1095 x 500 x 18

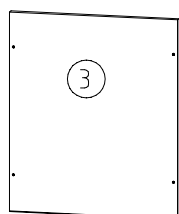

3x 429 x 500 x 18

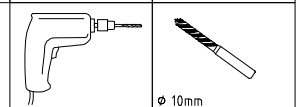
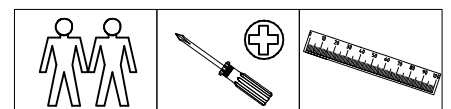

Ø 10mm

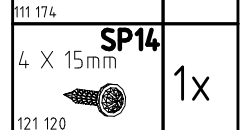
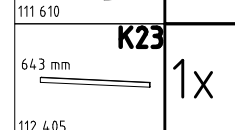
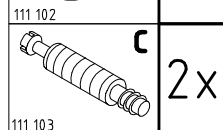
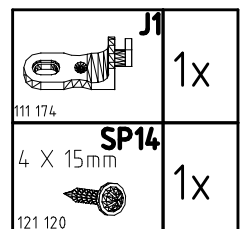
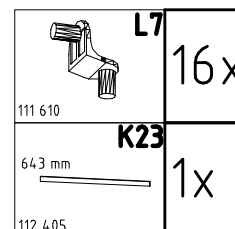
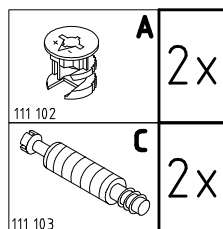

1486x500x15

980756

17.06.11 / 09.09.13

09 13

1/4

1

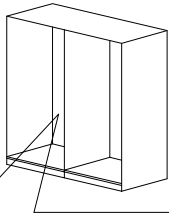

K22  
1088mm  
112 404

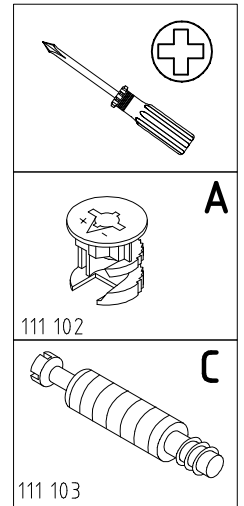
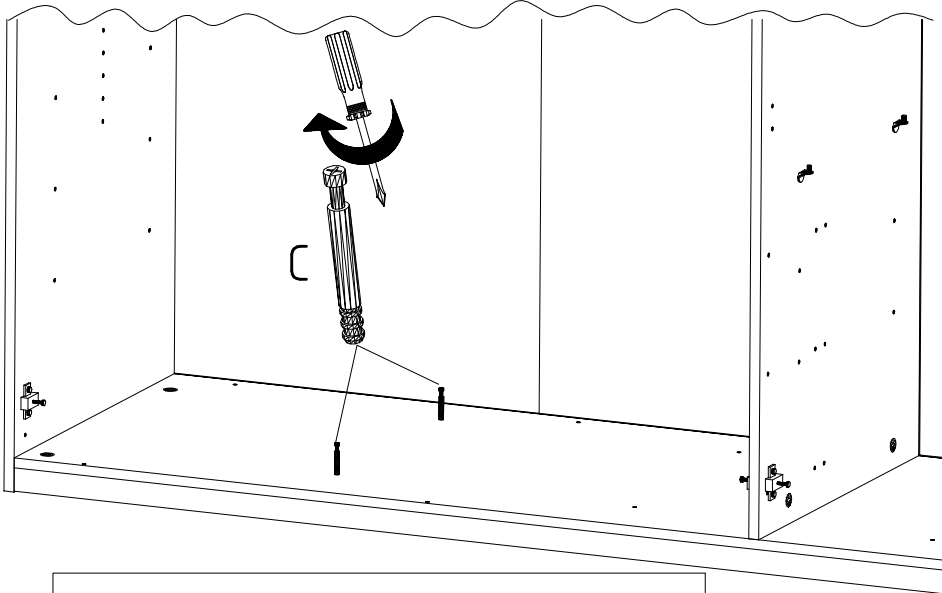
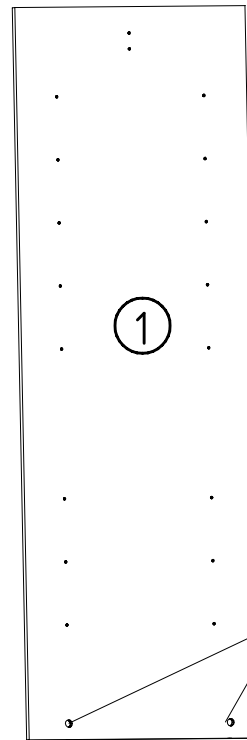
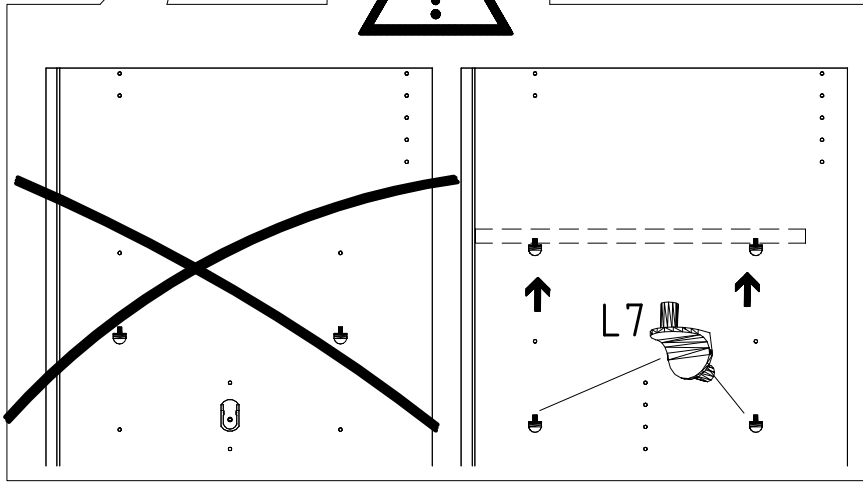
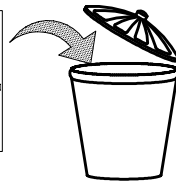

2

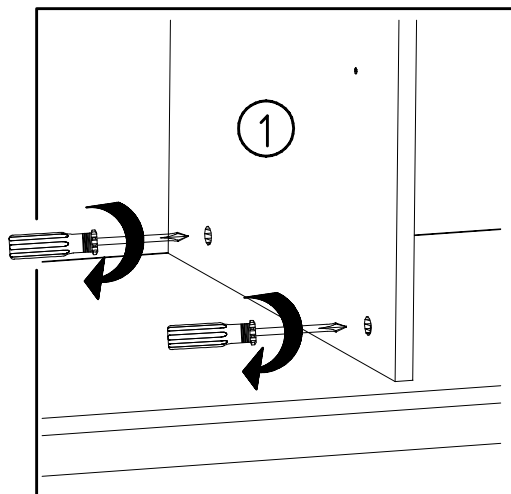
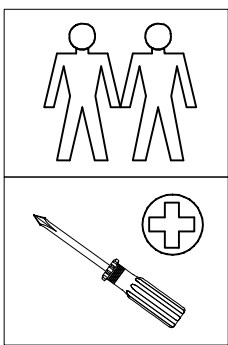
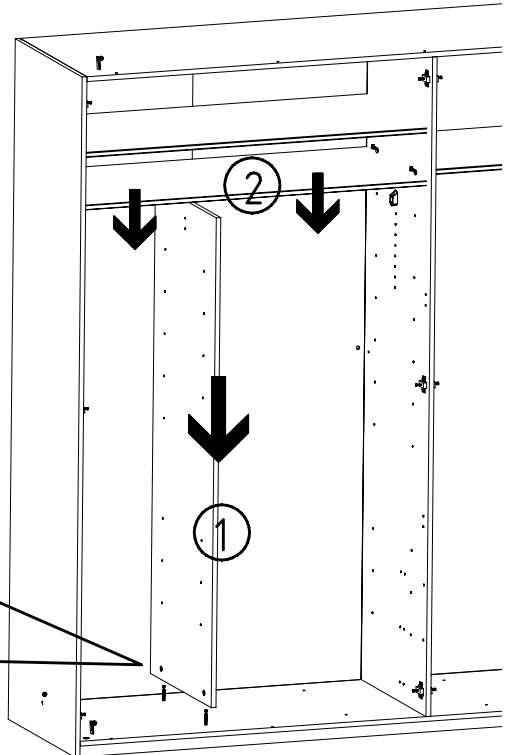
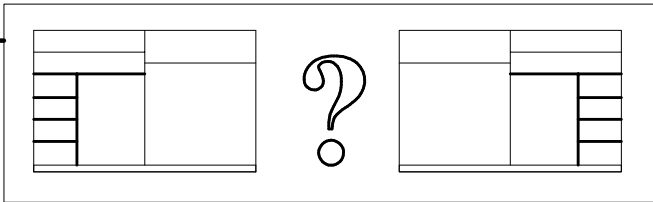

3

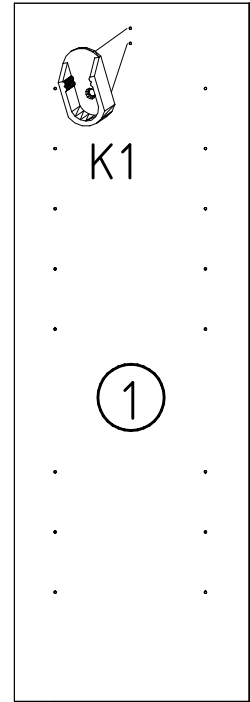
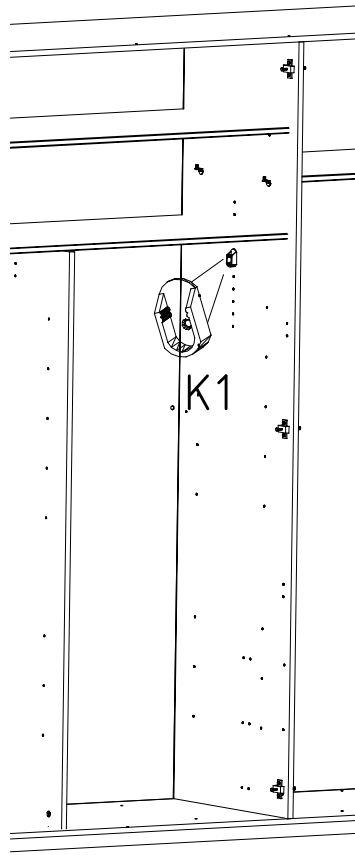
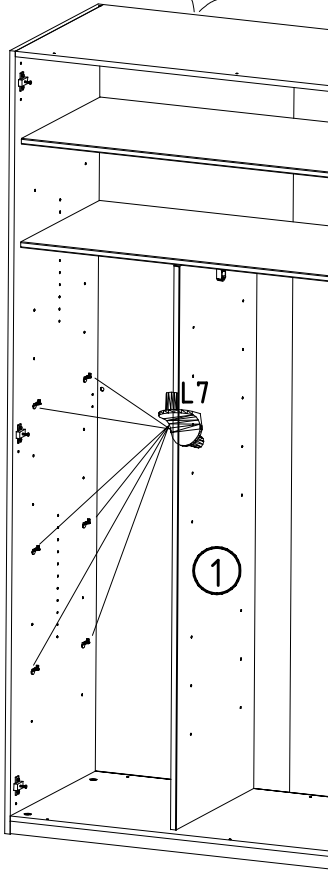
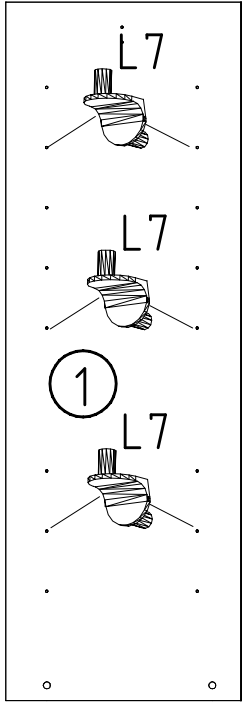
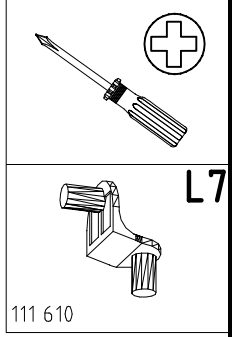
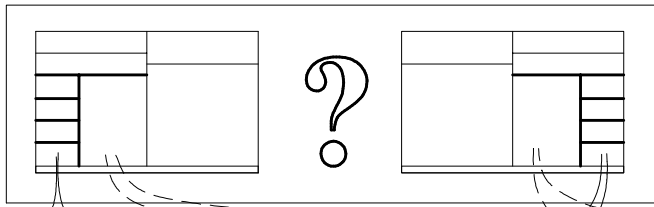

4

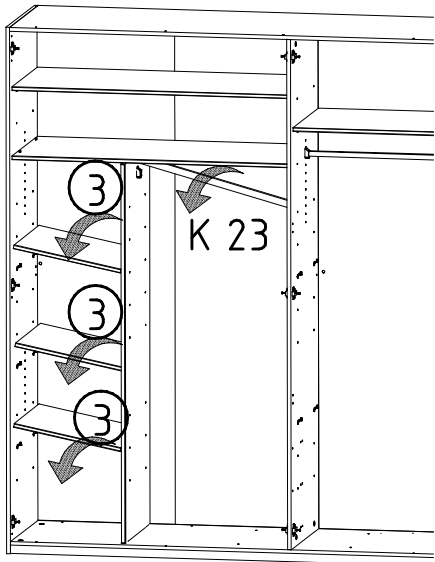
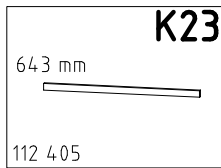

5

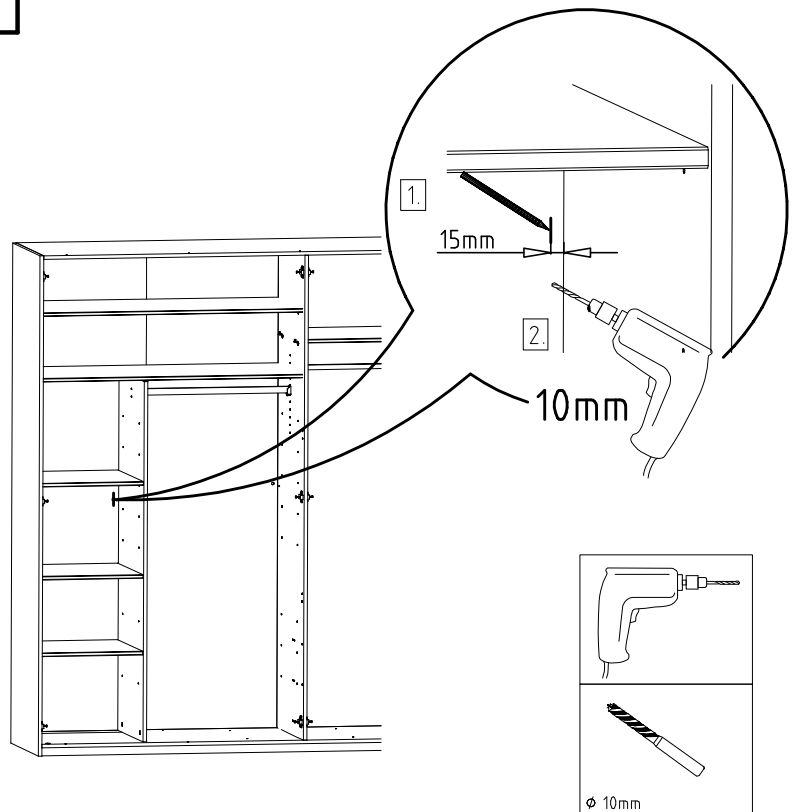



980756

17.06.11 / 09.09.13

09 13

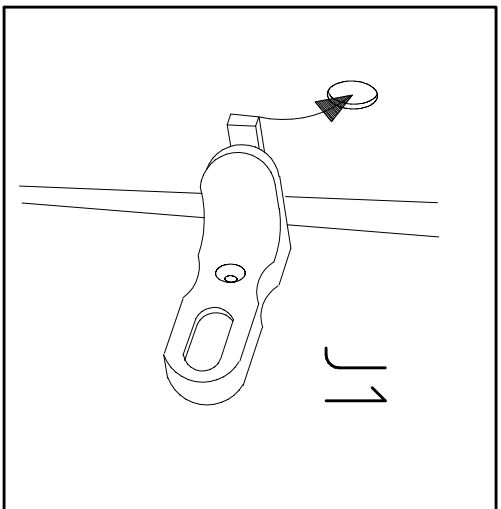
3/4

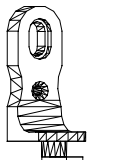

 J1	111 174
 SP14 4 X 15mm	121 120
