

**NR 1**

<b>T10</b>		x3
<b>T13</b>		x3
<b>M1</b>		x4
<b>T1</b>		x4
<b>B2</b>		φ 8x45 x5

Tabelle mit Maßen/Menge  
und Colli-Nr. der Einzelteile

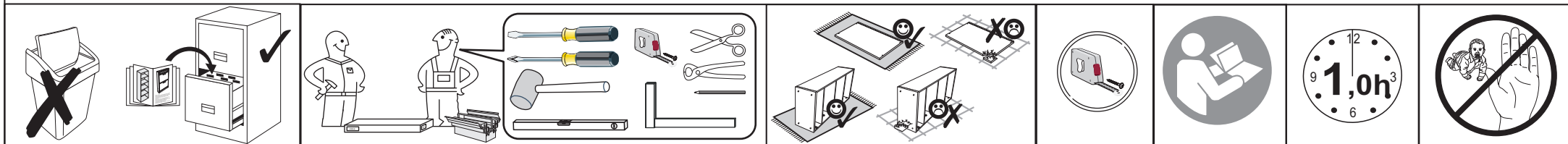

NO	Dim.		Col.-No	Qty
1	1552	772	1	1
2	1600	42	1	1

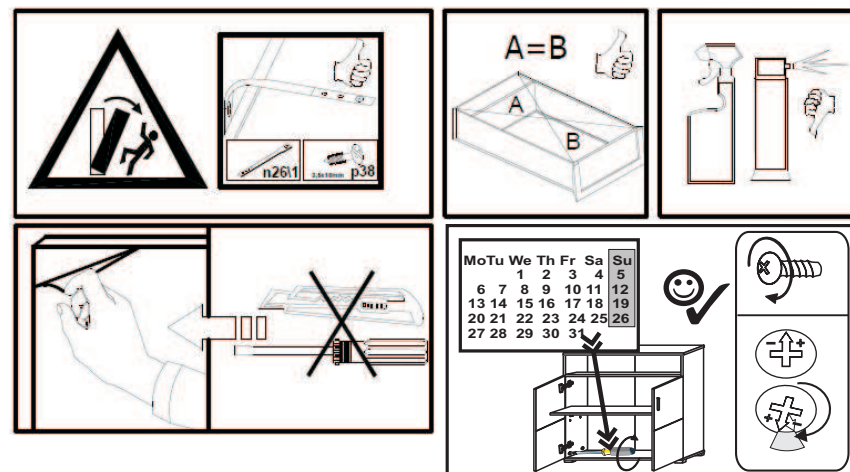
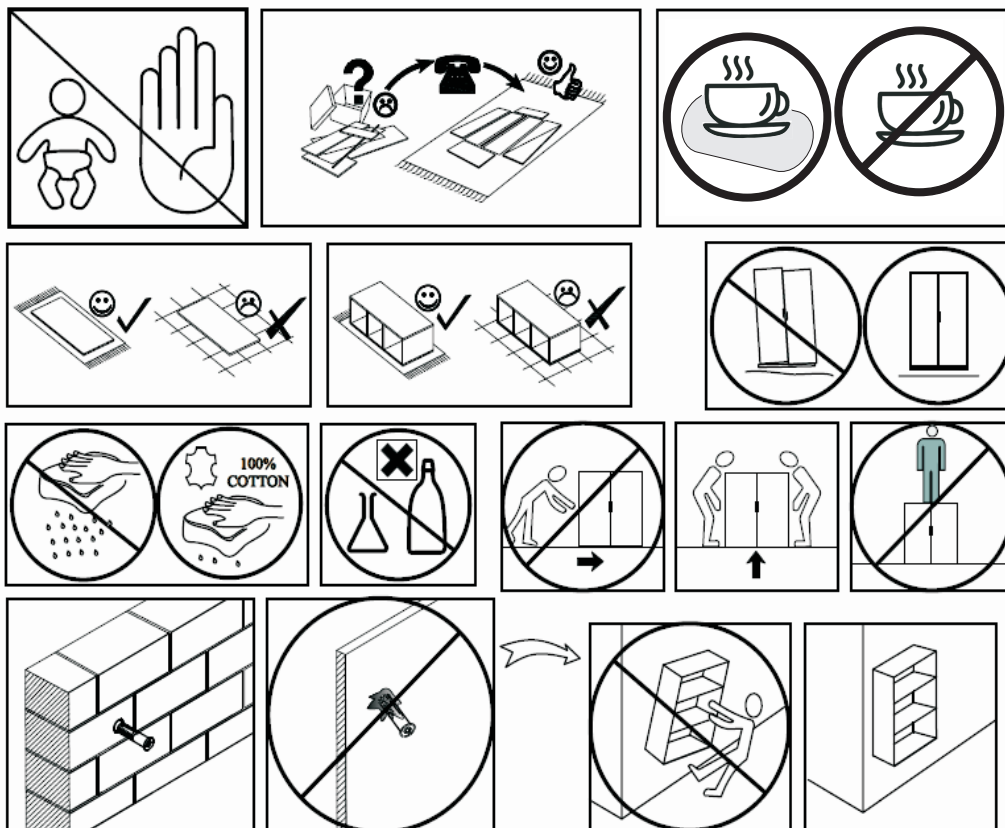
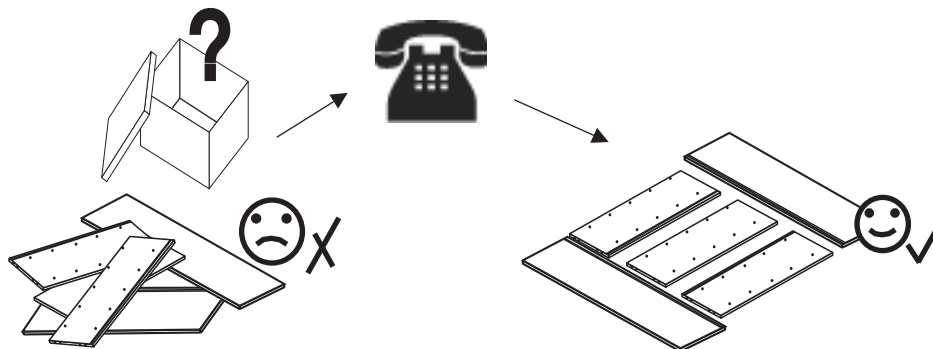

STRANA



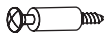

**1**

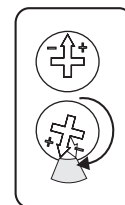
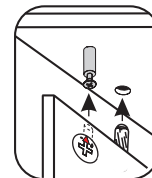
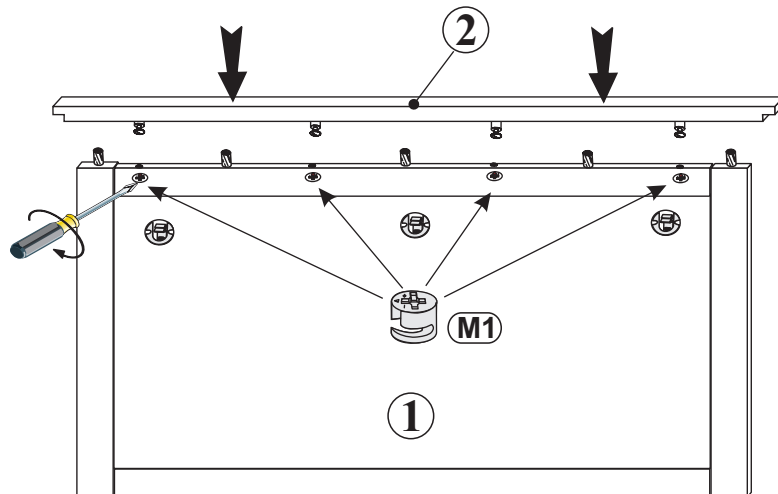
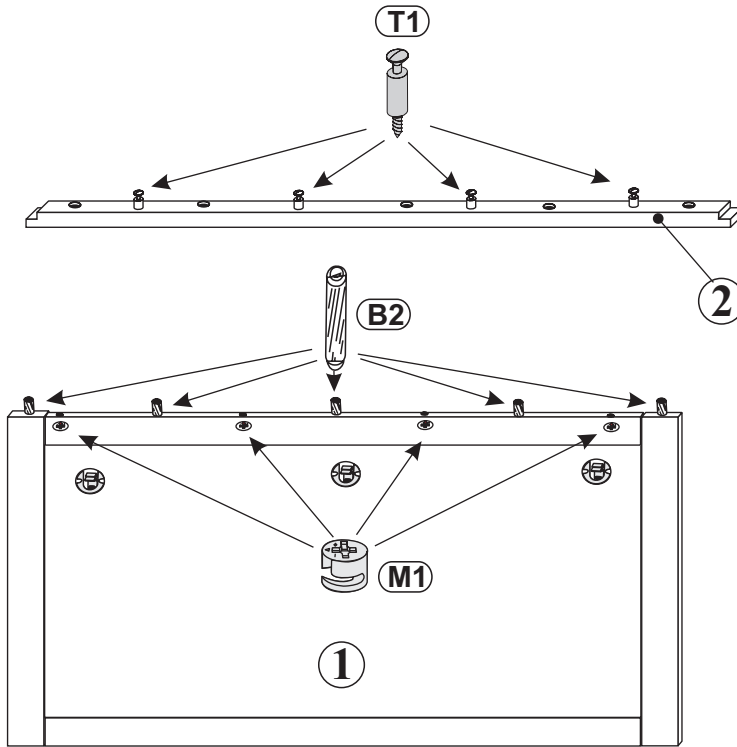
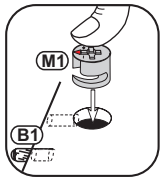
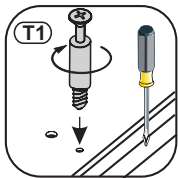
- M1**  x4
- T1**  x4
- B2**   $\phi$  8x45 x5



**2**

- T10**  x3
- T13**  x3

